

Macmillan/McGraw-Hill

READING
Triumphs

GRADE 1

**Practice
Book**



حامد اسکندری
HAMED SKANDARI . IR



Dear Family Member or Caregiver:

Welcome! This year your child will be building important reading skills. By working together, you and your child can become partners in learning.

Each week your child will bring home a Take-Home Story for the two of you to read together and discuss. You can help your child review vocabulary words and practice key reading skills taught that week.

Your interest, praise, and encouragement are sure to lead to your child's success in school. Here's to an exciting year of learning!

Yours truly,

B

The McGraw-Hill Companies

**Mc
Graw
Hill** Macmillan/McGraw-Hill

Published by Macmillan/McGraw-Hill, of McGraw-Hill Education, a division of The McGraw-Hill Companies, Inc., Two Penn Plaza, New York, New York 10121.

Copyright © by The McGraw-Hill Companies, Inc. All rights reserved. No part of this publication may be reproduced or distributed in any form or by any means, or stored in a database or retrieval system, without the prior written consent of The McGraw-Hill Companies, Inc., including, but not limited to, network storage or transmission, or broadcast for distance learning.

Printed in the United States of America

2 3 4 5 6 7 8 9 10 HSO 15 14 13 12 II

Contents

Get Started! (Readiness)

Week 1: Lessons 1-5

Phonics	1
Phonics	2
Take-Home Book	3
Phonics	5
Phonics	6
Take-Home Book	7

Week 2: Lessons 6-10

Phonics	9
Phonics	10
Take-Home Book	11
Phonics	13
Phonics	14
Take-Home Book	15

Week 3: Lessons 11-15

Phonics	17
Phonics	18
Take-Home Book	19
Phonics	21
Phonics	22
Take-Home Book	23

Week 4: Lessons 16-20

Phonics	25
Phonics	26
Take-Home Book	27
Phonics	29
Phonics	30
Take-Home Book	31

Week 5: Lessons 21-25

Take-Home Book	33
Phonics	35
Phonics	36
Take-Home Book	37

Unit 1

Week 1: Lessons 1-5

Pam Ran; Sam Can Nap	
Phonemic Awareness: Short /a/	39
Phonics: Short <i>a</i>	40
Vocabulary: High-Frequency Words	41
Comprehension: Character and Setting	42
Take-Home Book	43

Week 2: Lessons 6-10

Tag; At Bat	
Phonemic Awareness: Short /a/	45
Phonics: Short <i>a</i>	46
Vocabulary: High-Frequency Words	47
Comprehension: Sequence	48
Take-Home Book	49

Week 3: Lessons 11-15

Can Jim Fit?; Big Max	
Phonemic Awareness: Short /i/	51
Phonics: Short <i>i</i>	52
Vocabulary: High-Frequency Words	53
Comprehension: Sequence	54
Take-Home Book	55

Week 4: Lessons 16-20

Clip, Clip!; Flag Can Do It	
Phonemic Awareness: /-Blends	57
Phonics: /-Blends	58
Vocabulary: High-Frequency Words	59
Comprehension: Plot	60
Take-Home Book	61

Week 5: Lessons 21-25

Big Cats; Ants, Ants, Ants!	
Phonemic Awareness: Final Blends	63
Phonics: Final Blends	64
Vocabulary: High-Frequency Words	65
Comprehension: Author's Purpose	66
Take-Home Book	67

Unit 2

Week 1: Lessons 1-5

I Can Hop; My Mom

Phonemic Awareness: Short /o/	69
Phonics: Short <i>o</i>	70
Vocabulary: High-Frequency Words	71
Comprehension: Main Idea/Details	72
Take-Home Book	73

Week 2: Lessons 6-10

Jen Helps Rex; On the Bed

Phonemic Awareness: Short /e/	75
Phonics: Short <i>e</i>	76
Vocabulary: High-Frequency Words	77
Comprehension: Retell	78
Take-Home Book	79

Week 3: Lessons 11-15

Frogs, Frogs, Frogs!; Kids Can

Phonemic Awareness: <i>r</i> -, <i>s</i> -Blends	81
Phonics: <i>r</i> -Blends, <i>s</i> -Blends	82
Vocabulary: High-Frequency Words	83
Comprehension: Main Idea/Details	84
Take-Home Book	85

Week 4: Lessons 16-20

Pup and Cat; Big Bud

Phonemic Awareness: Short /u/	87
Phonics: Short <i>u</i>	88
Vocabulary: High-Frequency Words	89
Comprehension: Plot	90
Take-Home Book	91

Week 5: Lessons 21-25

Sing This Song!; At the Shop

Phonemic Awareness: /sh/, /th/, /ng/	93
Phonics: Digraphs <i>sh</i> , <i>th</i> , <i>-ng</i>	94
Vocabulary: High-Frequency Words	95
Comprehension: Retell	96
Take-Home Book	97

Unit 3

Week 1: Lessons 1-5

Dave and Kate; Jake's Cake

Phonemic Awareness: Long /ā/	99
Phonics: Long <i>a</i> (<i>a_e</i>)	100
Vocabulary: High-Frequency Words	101
Comprehension: Retell	102
Take-Home Book	103

Week 2: Lessons 6-10

Five Ducks and a Frog; Miss Fine's Dime

Phonemic Awareness: Long /ī/	105
Phonics: Long <i>i</i> (<i>i_e</i>)	106
Vocabulary: High-Frequency Words	107
Comprehension: Make Predictions	108
Take-Home Book	109

Week 3: Lessons 11-15

Let's Eat Lunch; Snakes, Snakes, Snakes!

Phonemic Awareness: /ch/, /hw/	111
Phonics: <i>ch</i> , <i>-tch</i> ; <i>wh</i> -	112
Vocabulary: High-Frequency Words	113
Comprehension: Main Idea/Details	114
Take-Home Book	115

Week 4: Lessons 16-20

Mole's Home; June's Flute

Phonemic Awareness: Long /ō/, /ū/	117
Phonics: Long <i>o</i> (<i>o_e</i>), <i>u</i> (<i>u_e</i>)	118
Vocabulary: High-Frequency Words	119
Comprehension: Draw Conclusions	120
Take-Home Book	121

Week 5: Lessons 21-25

Stripes, Stripes, Stripes!; Let's Help!

Phonemic Awareness: Three-Letter Blends	123
Phonics: Three-Letter Blends	124
Vocabulary: High-Frequency Words	125
Comprehension: Compare/Contrast	126
Take-Home Book	127

Unit 4

Week 1: Lessons 1-5

It Is Raining

Phonemic Awareness: Long /ā/.	129
Phonics: Long <i>a</i> (<i>ai, ay</i>)	130
Vocabulary: High-Frequency Words	131
Comprehension: Make Predictions	132
Take-Home Book.	133

Week 2: Lessons 6-10

Up a Tree

Phonemic Awareness: Long /ē/.	135
Phonics: Long <i>e</i> (<i>e, ea, ee</i>)	136
Vocabulary: High-Frequency Words	137
Comprehension: Character and Setting	138
Take-Home Book.	139

Week 3: Lessons 11-15

Let's Go!

Phonemic Awareness: Long /ō/.	141
Phonics: Long <i>o</i> (<i>o, oa, ow</i>)	142
Vocabulary: High-Frequency Words	143
Comprehension: Retell	144
Take-Home Book.	145

Week 4: Lessons 16-20

The Light

Phonemic Awareness: Long /ī/.	147
Phonics: Long <i>i</i> (<i>i, igh, y</i>)	148
Vocabulary: High-Frequency Words	149
Comprehension: Plot	150
Take-Home Book.	151

Week 5: Lessons 21-25

Lilly Cleans Up

Phonemic Awareness: Long /ē/.	153
Phonics: Long <i>e</i> (<i>-y, -ey</i>)	154
Vocabulary: High-Frequency Words	155
Comprehension: Retell	156
Take-Home Book.	157

Unit 5

Week 1: Lessons 1-5

Birds' Nests

Phonemic Awareness: /ûr/.	159
Phonics: <i>r</i> -Controlled Vowels <i>er, ir, ur</i>	160
Vocabulary: High-Frequency Words	161
Comprehension: Cause/Effect	162
Take-Home Book.	163

Week 2: Lessons 6-10

At the Big Park

Phonemic Awareness: /âr/.	165
Phonics: <i>r</i> -Controlled Vowel <i>ar</i>	166
Vocabulary: High-Frequency Words	167
Comprehension: Make Inferences	168
Take-Home Book.	169

Week 3: Lessons 11-15

Fun with Sports

Phonemic Awareness: /ôr/.	171
Phonics: <i>r</i> -Controlled Vowels <i>or, ore</i>	172
Vocabulary: High-Frequency Words	173
Comprehension: Compare/Contrast	174
Take-Home Book.	175

Week 4: Lessons 16-20

Jack and the Beans

Phonemic Awareness: /ou/.	177
Phonics: Diphthongs <i>ou, ow</i>	178
Vocabulary: High-Frequency Words	179
Comprehension: Sequence	180
Take-Home Book.	181

Week 5: Lessons 21-25

Joy's Surprise

Phonemic Awareness: /oi/.	183
Phonics: Diphthongs <i>oi, oy</i>	184
Vocabulary: High-Frequency Words	185
Comprehension: Sequence	186
Take-Home Book.	187

Unit 6

Week 1: Lessons 1-5

Toys at Night

Phonemic Awareness: /ù/, /ü/	189
Phonics: Vowel Digraphs <i>oo, oo, ew, ou</i>	190
Vocabulary: High-Frequency Words	191
Comprehension: Fantasy/Reality	192
Take-Home Book.	193

Week 2: Lessons 6-10

Paws and Claws

Phonemic Awareness: /ô/	195
Phonics: Vowel Digraphs <i>au, aw, al</i>	196
Vocabulary: High-Frequency Words	197
Comprehension: Make Inferences	198
Take-Home Book.	199

Week 3: Lessons 11-15

The Seasons

Phonemic Awareness: Syllables	201
Phonics: Open and Closed Syllables.	202
Vocabulary: High-Frequency Words	203
Comprehension: Classify and Categorize	204
Take-Home Book.	205

Week 4: Lessons 16-20

Let's Plant Seeds

Phonemic Awareness: Syllables	207
Phonics: Open and Closed Syllables.	208
Vocabulary: High-Frequency Words	209
Comprehension: Make Predictions	210
Take-Home Book.	211

Week 5: Lessons 21-25

Three Billy Goats

Phonemic Awareness: Syllables	213
Phonics: Final Stable Syllables	214
Vocabulary: High-Frequency Words	215
Comprehension: Character and Setting	216
Take-Home Book.	217

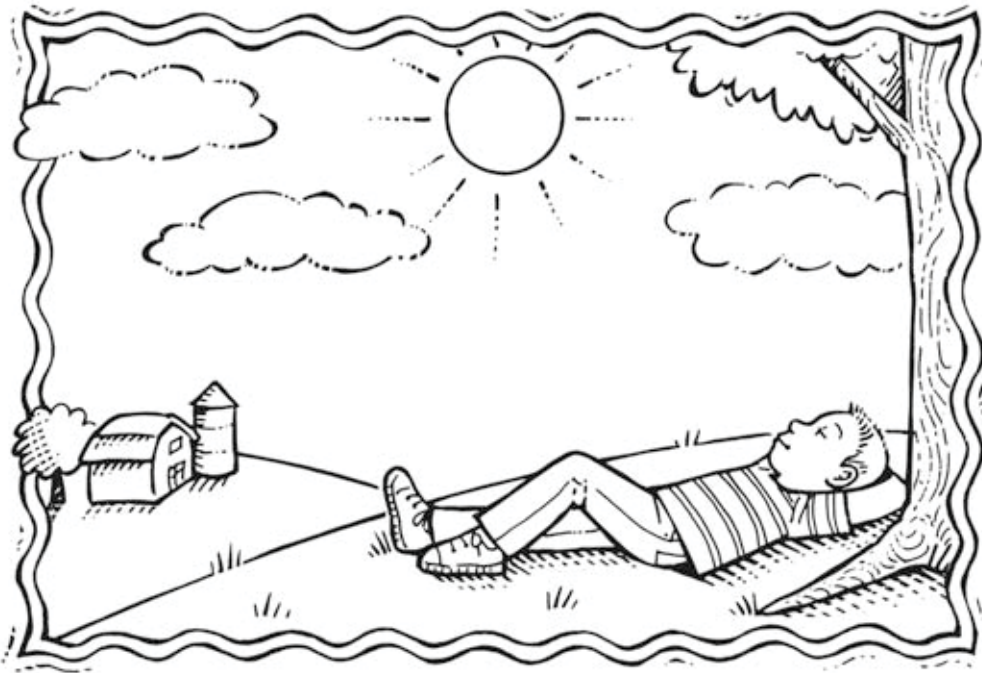

Name _____

Say each picture name. Write the letter that stands for the sound at the beginning of its name.

1.

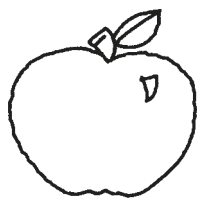

2.

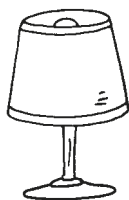

3.



4.



5.



Name _____

Say each picture name. Write the letter that stands for the sound at the beginning of its name.

1.  _____

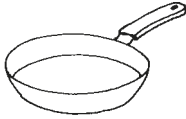
2.  _____

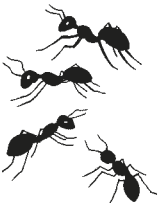
3.  _____

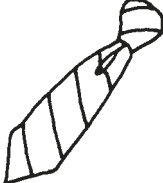
4.  _____

5.  _____

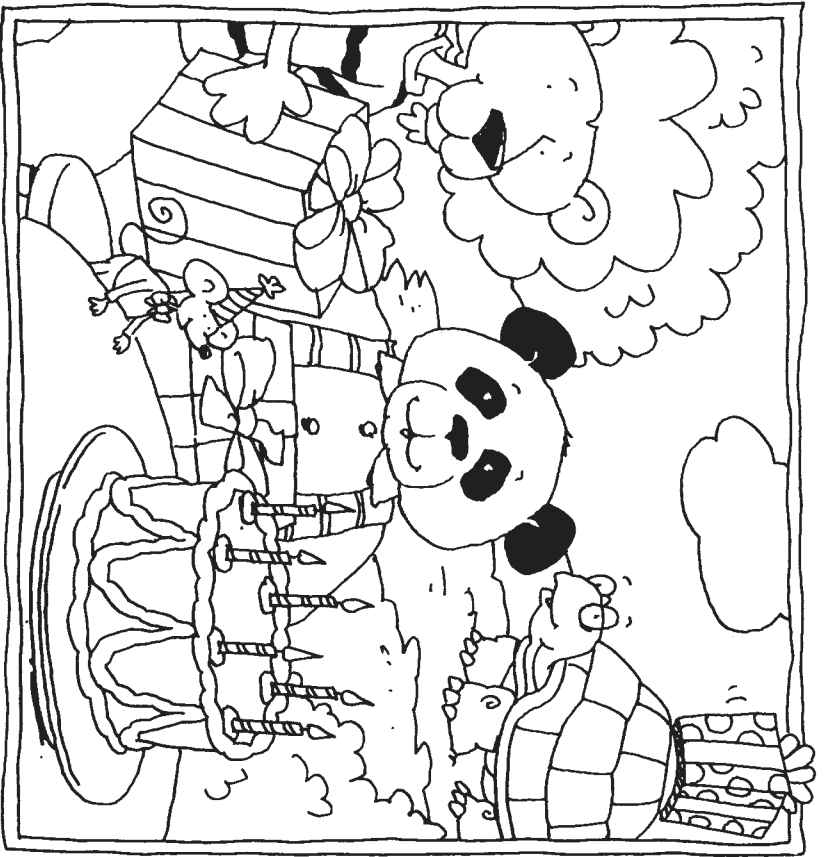

I am a  .
mouse

I Am



I am a  .
lion

High-Frequency Words:
Circle the words I and a
in the story.



At Home: Ask your
child to read the
book aloud to you.

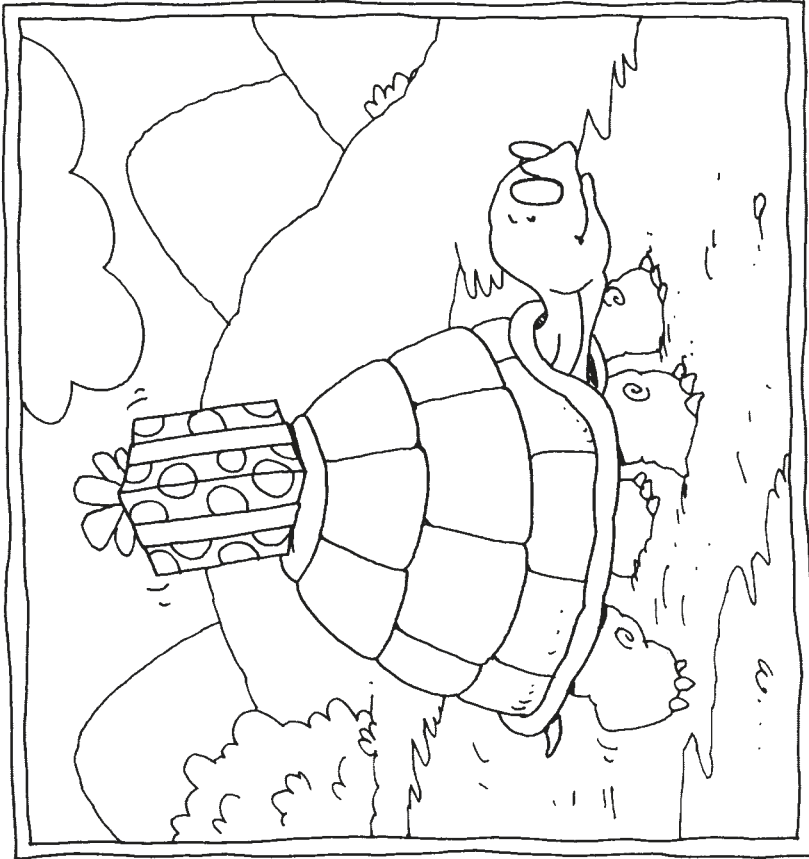

I am a .
turtle

Phonics: Circle the animals that have two syllables in their names.

2



I am a .
panda

Comprehension: Where are the animals going?

3

Name _____

A. Say the name of the picture. Listen to the beginning sound. Then write the letter.

1.

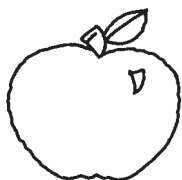

a

2.

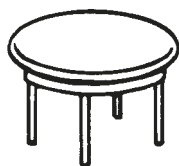

t

3.



m

B. Blend the sounds and say the word. Write the word.

1. am



2. at



Name _____

Blend the sounds and say the word. Write the word.

1. **am**



2. **Pam**



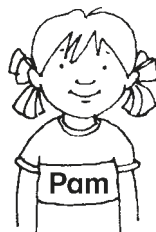

3. **at**



4. **mat**



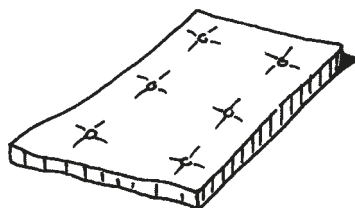



I like
peanuts .



At Home: Ask your child to read the book aloud to you.

High-Frequency Words:
Circle the words **I** and **like** in the story.

I Like



I like
trees .



I like .
leaves

Phonics: Find something in the story that starts with **m**. Color it brown.

2



I like .
monkeys

Comprehension: What is in the tree house?

3

Name _____

Say each picture name. Write the letter that stands for the sound at the beginning of its name.

1.

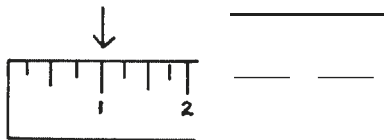

2.



3.

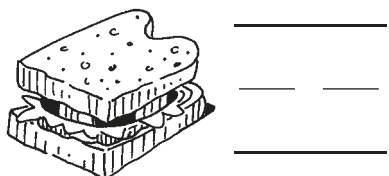

4.

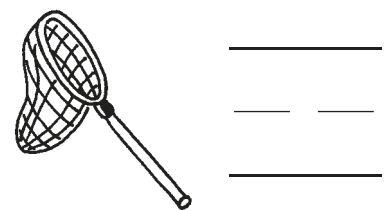

5.

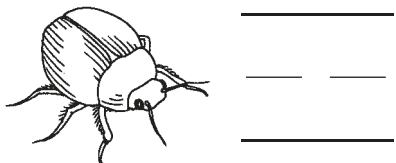

Name _____

Say each picture name. Write the letter that stands for the sound at the beginning of its name.

1.

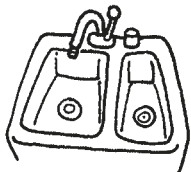

2.

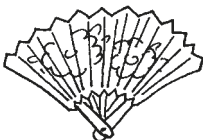

3.



4.



5.

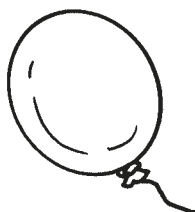

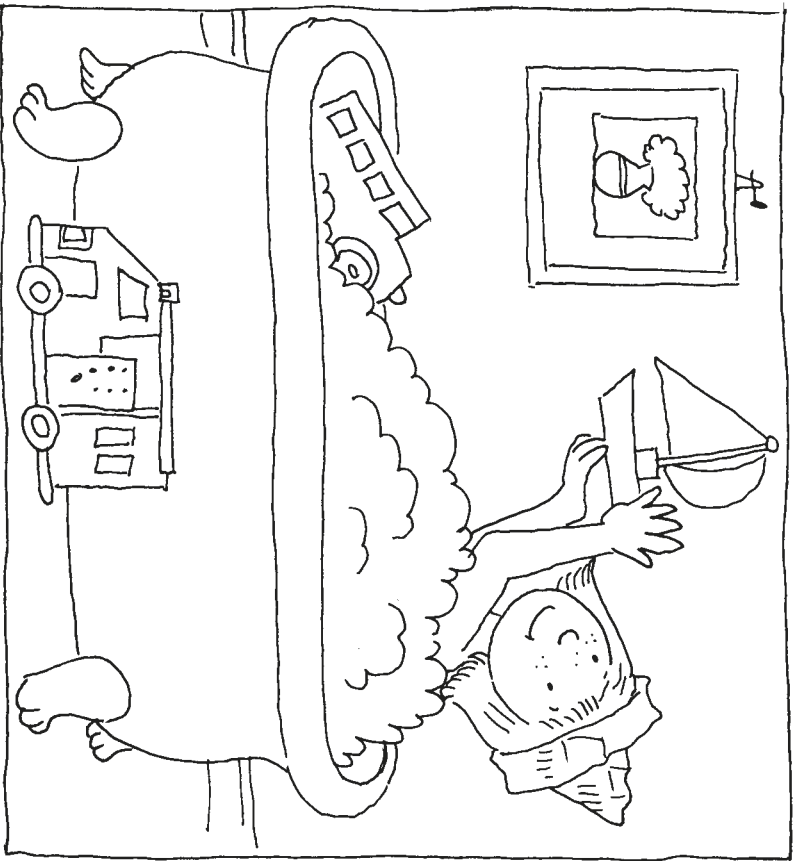

I am in a  !
 bathtub

4

High-Frequency Words:
 Circle the word in in the
 story.



At Home: Ask your
 child to read the
 book aloud to you.

© Macmillan/McGraw-Hill

I Am in It

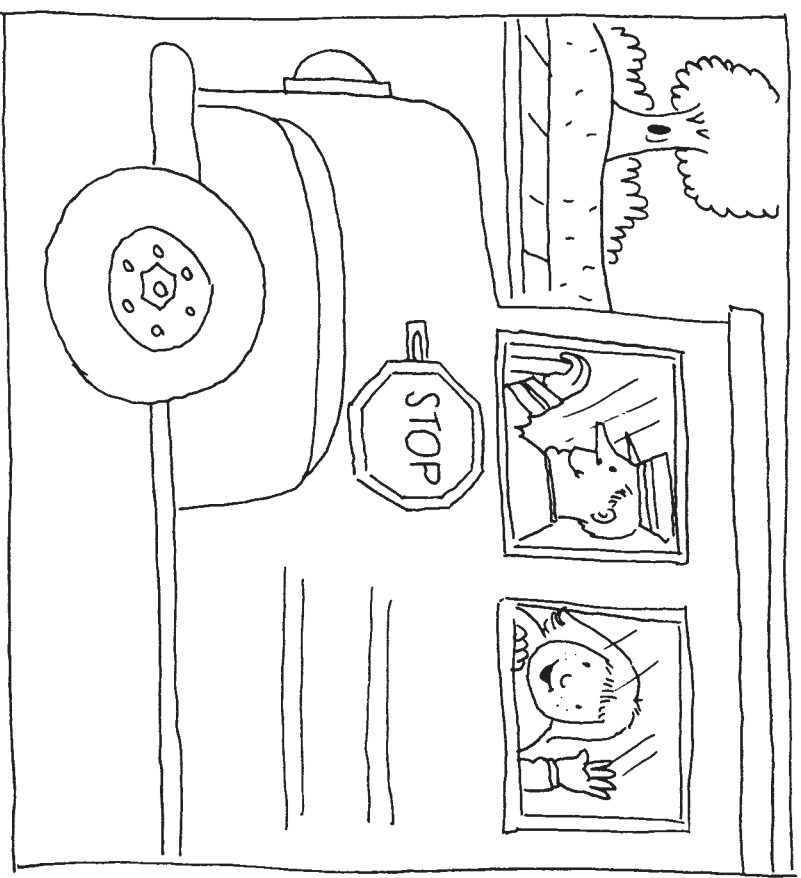

I am in a  .
 school bus

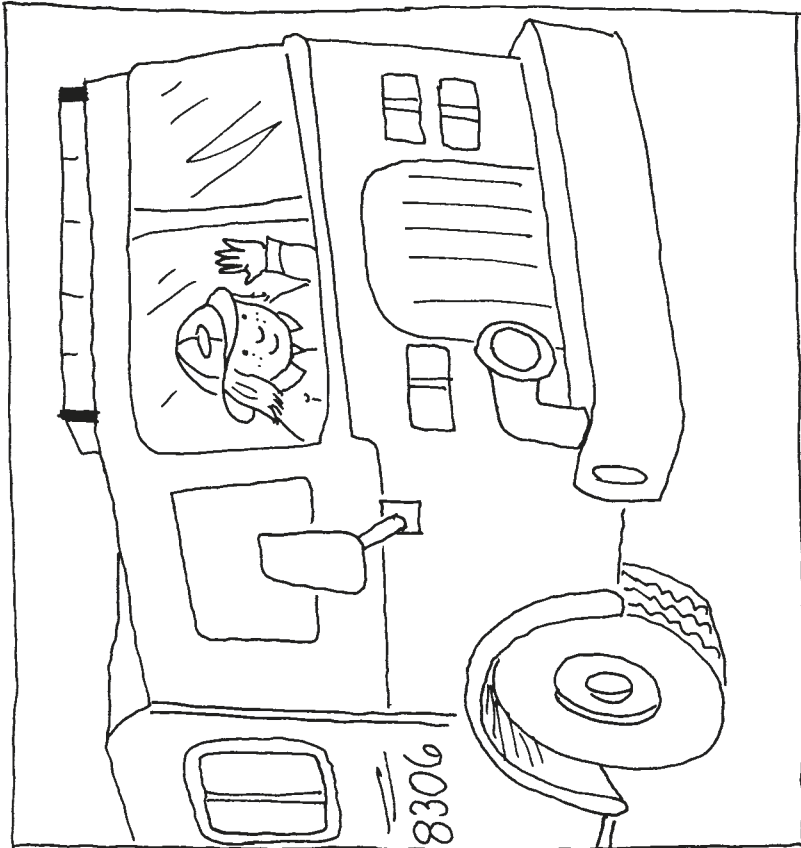

I am in a  .
fire truck

Phonics: Find two things in the story that start with **b**. Color them blue.

2

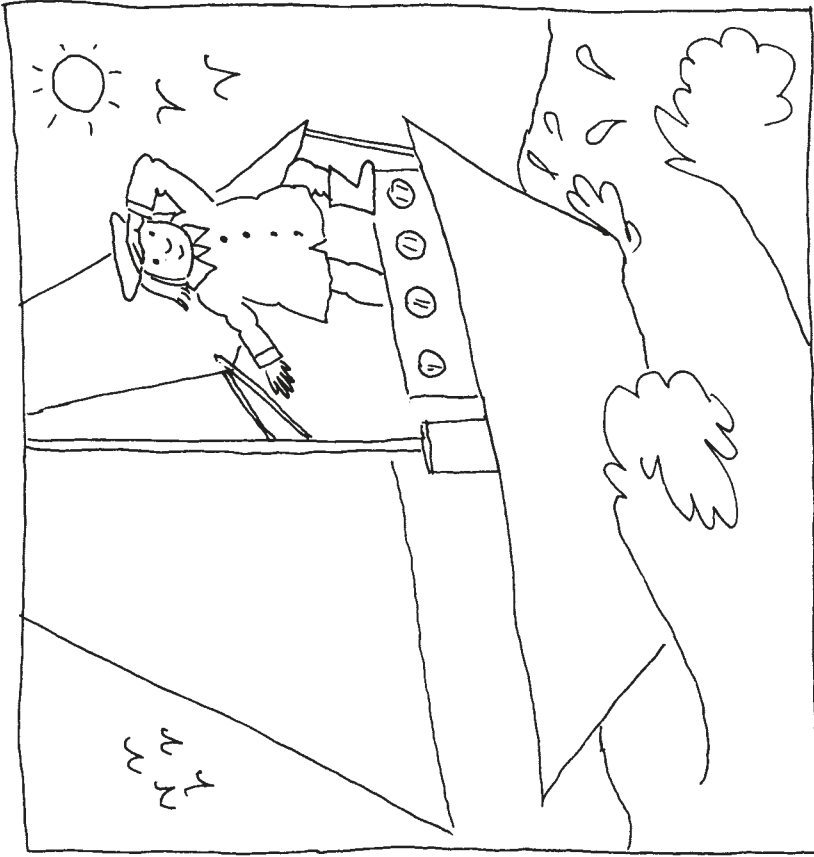

I am in a  .
boat

Comprehension: Where is the girl?

3

Name _____

A. Say the name of each picture. Listen to the beginning sound. Then write the letter.

1.



i _____

2.

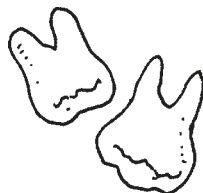

t _____

3.

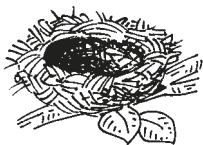

n _____

B. Blend the sounds and say the word. Write the word.

1. in



2. it



Name _____

Blend the sounds and say the word. Write the word.

1. **in**
→

2. **pin**
→

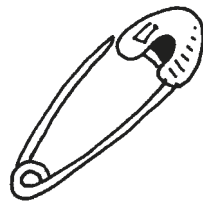

3. **it**
→

4. **sit**
→

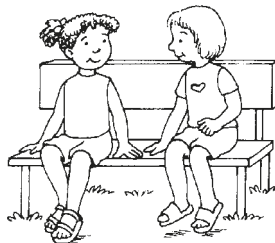

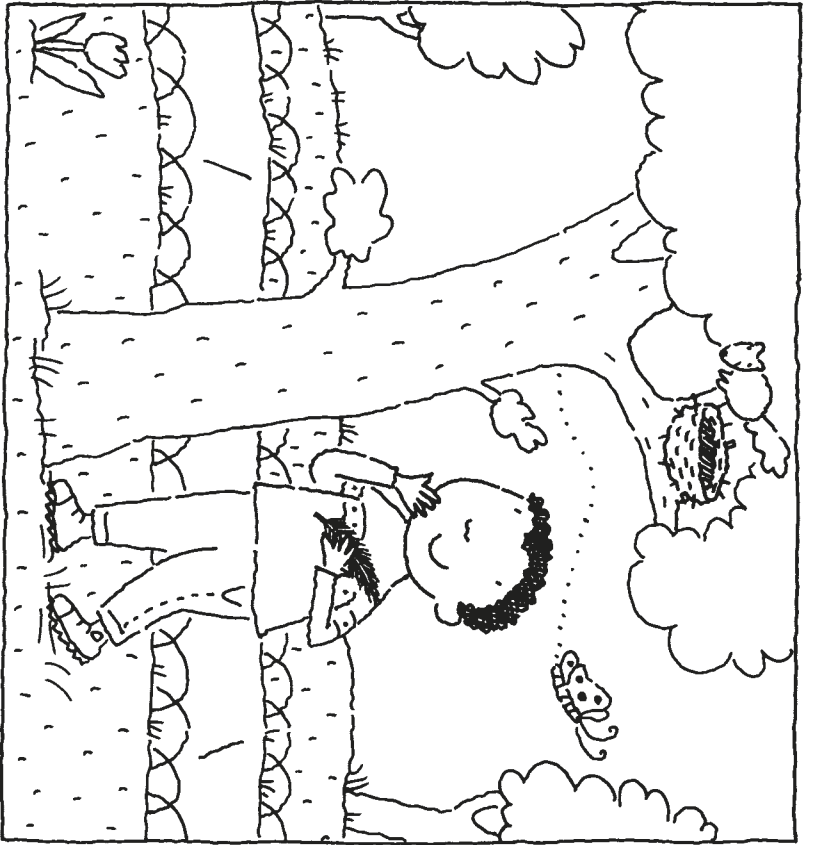

I see a
nest .

I like it!

High-Frequency Words:
Circle the word see in the
story.

4



At Home: Ask your
child to read the
book aloud to you.

I Like It

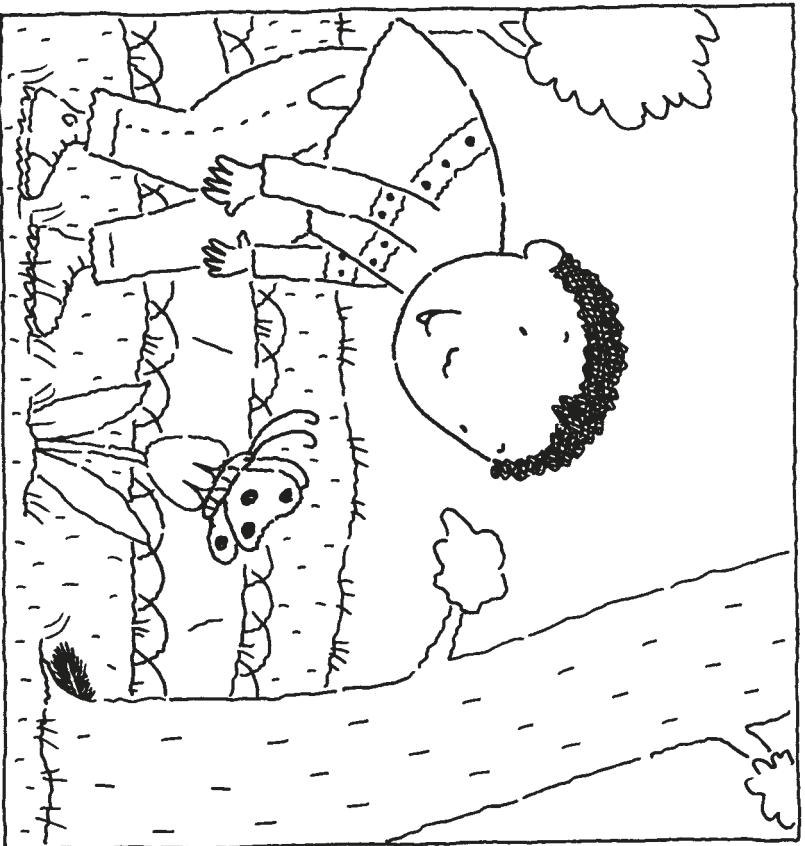

I see a
butterfly .

I like it!

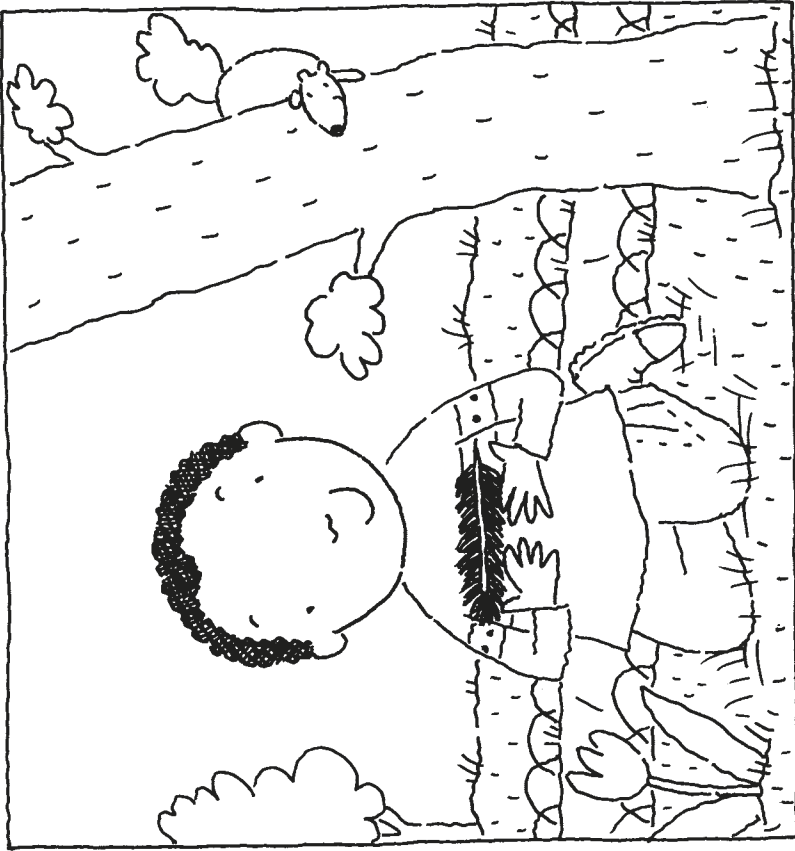

I see a .
feather

I like it!

Phonics: Find something in the story that has three syllables in its name. Color it purple.

2

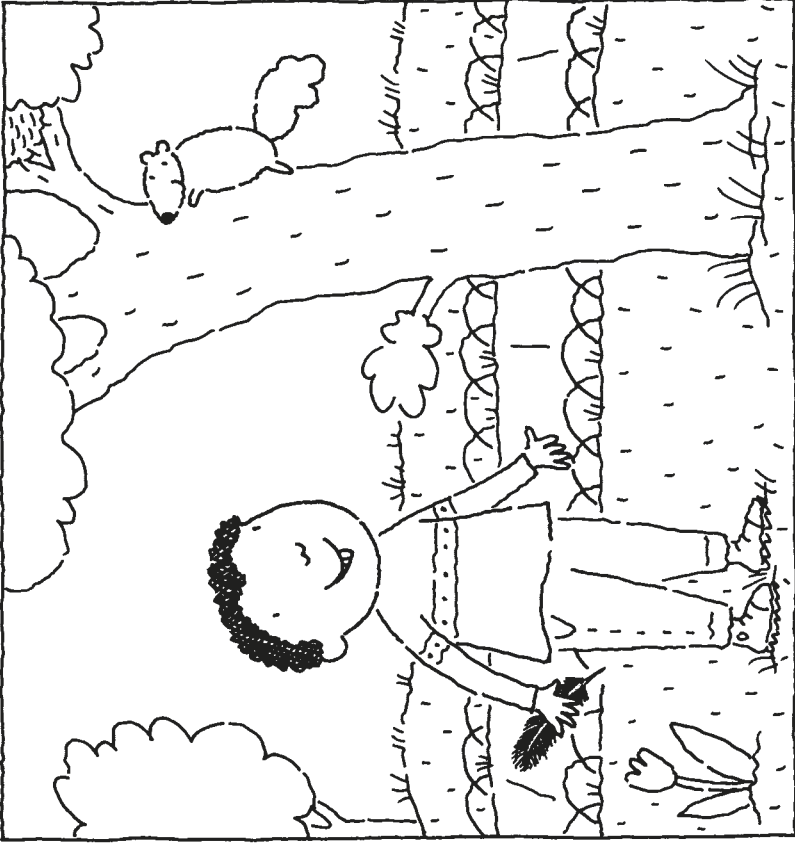

I see a .
squirrel

I like it!

Comprehension: What is the boy looking at?

3

Name _____

Say each picture name. Write the letter that stands for the sound at the beginning of its name.

1.



2.

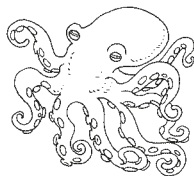

3.

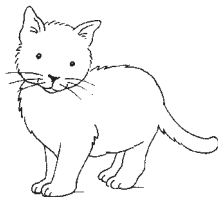

4.



5.

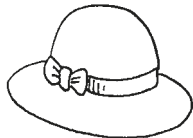

Name _____

Say each picture name. Write the letter that stands for the sound at the beginning of its name.

1.

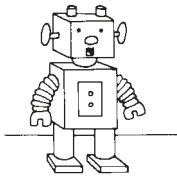

2.



3.

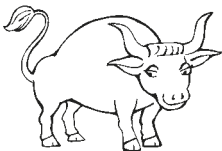

4.

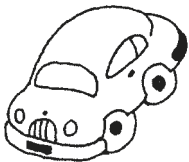

5.



On the Horse

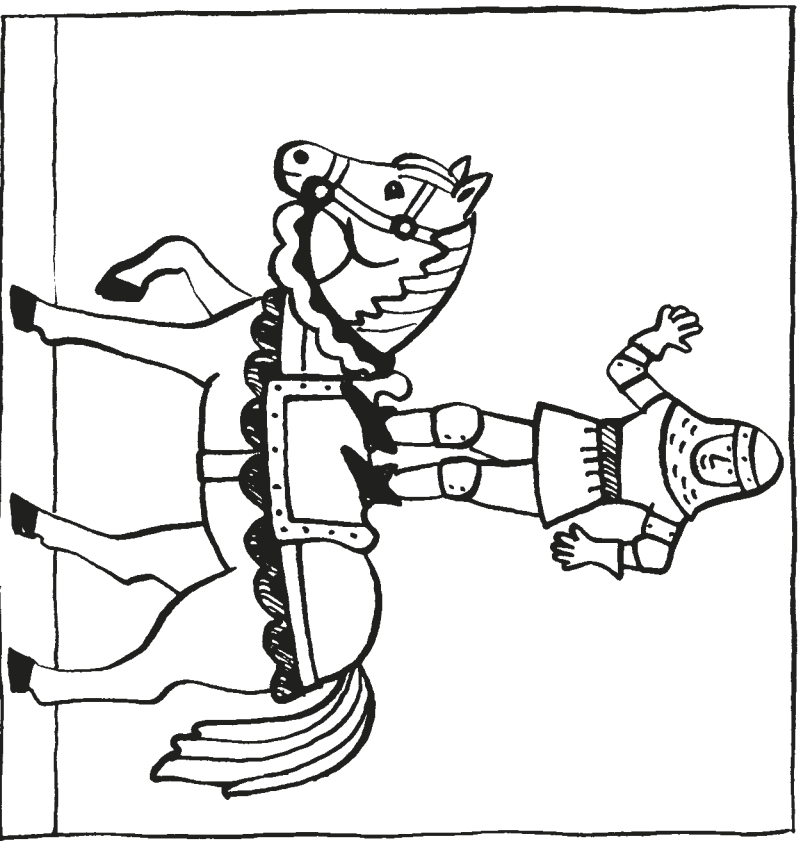

I am on the  .

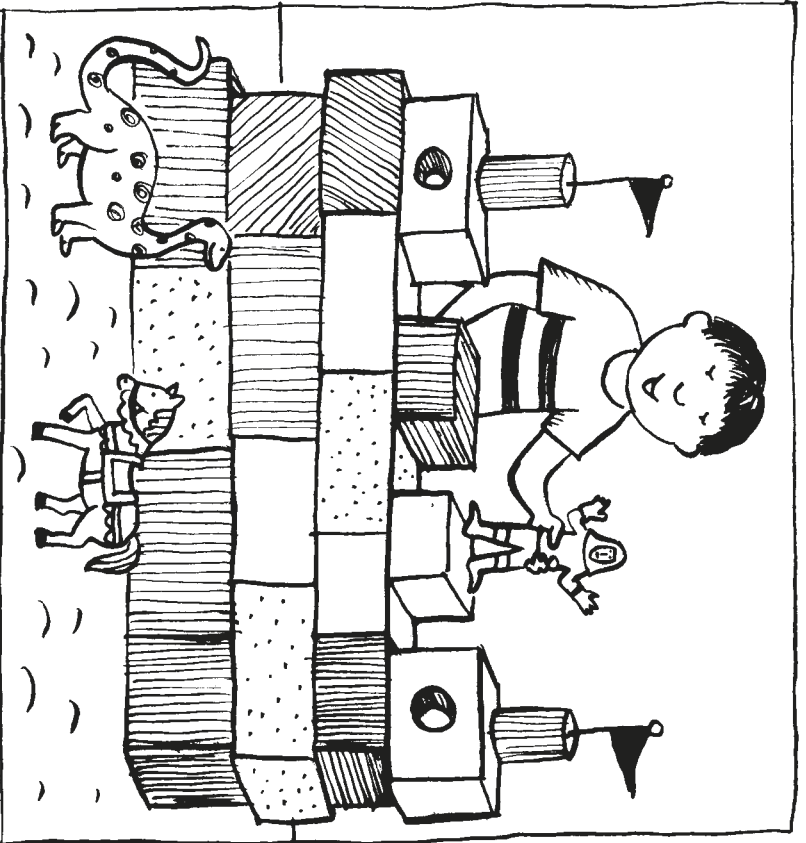

I am on the  .

High-Frequency Words:
Circle the word the in the
story.



At Home: Ask your
child to read the
book aloud to you.

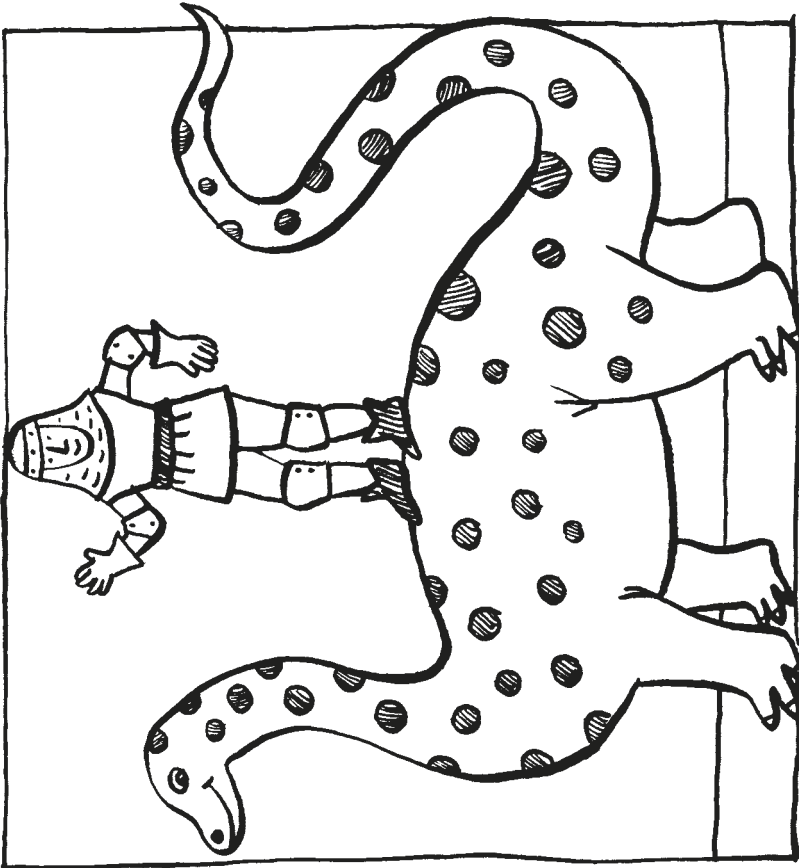

I am on the  dinosaur.

Phonics: Find something in the story that rhymes with **bug**. Circle it.

2

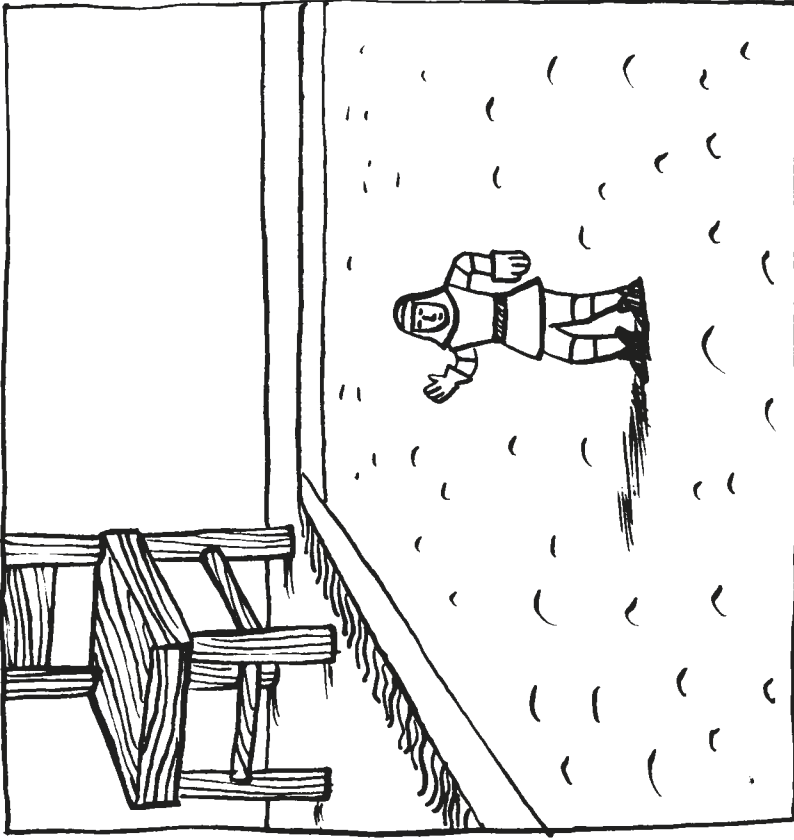

I am on the  rug.

Comprehension: How did the toy get from the dinosaur to the rug?

3

Name _____

A. Say the name of each picture. Listen to the beginning sound. Then write the letter.

1.

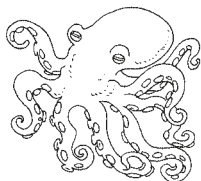

2.



B. Blend the sounds and say the word. Write the word.

1. on



Name _____

Blend the sounds and say the word. Write the word.

1. **on**
→

2. **top**
→



3. **mop**
→



4. **stop**
→



I See

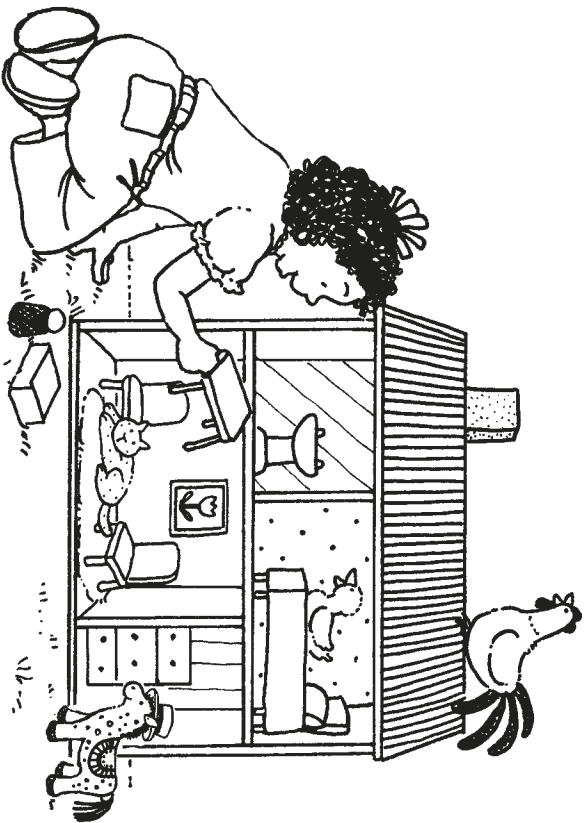

I see the  .
rooster

It is on a  .
roof

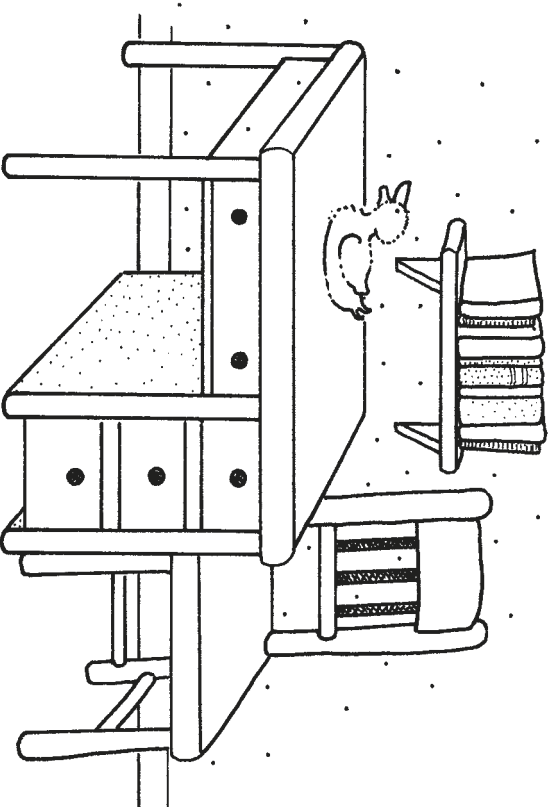

I see the  .
duck

It is on a  .
desk

 **At Home:** Ask your child to read the book aloud to you.

High-Frequency Words:
Circle the word the in the story.

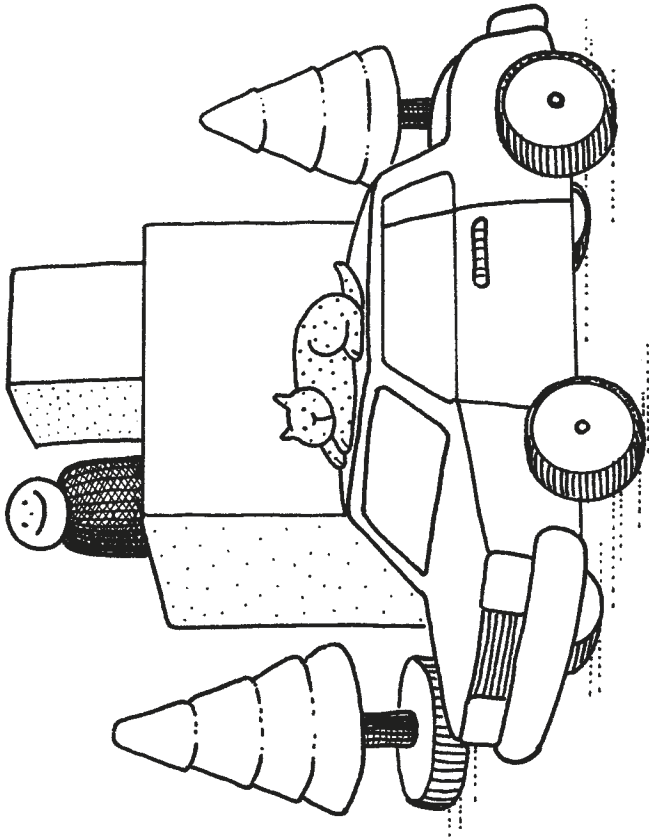

I see the  .
cat

It is on a  .
car

Phonics: Find two things in the story that rhyme with **rat**. Circle them.

2

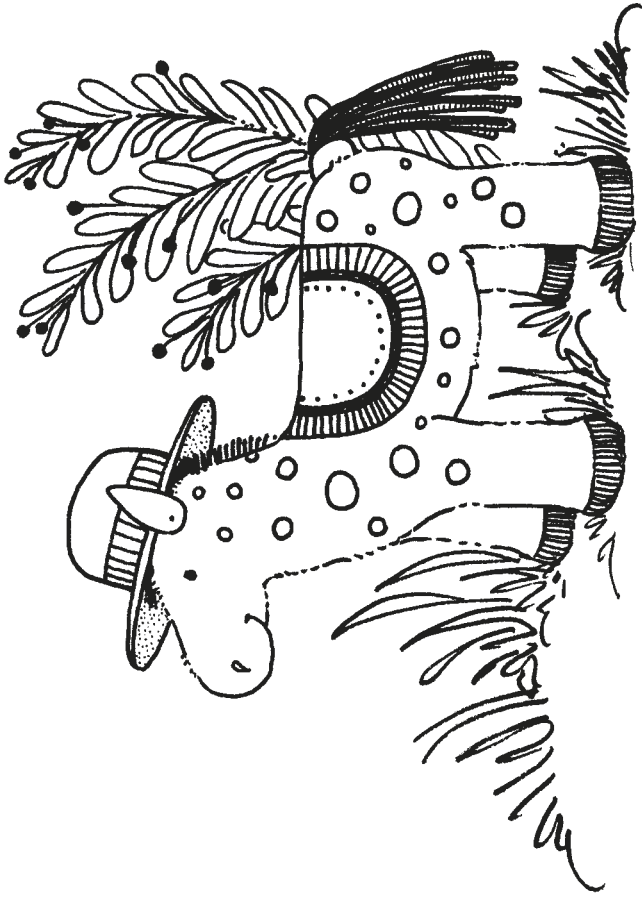

I see the  .
hat

It is on a  .
horse

Comprehension: Who put the animals in the dollhouse?

3

Name _____

Say each picture name. Write the letter that stands for the sound at the beginning of its name.

1.

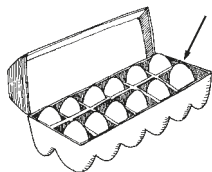

2.

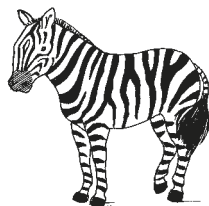

3.

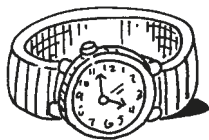

4.

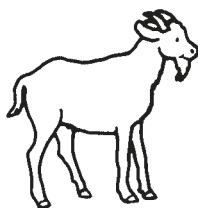

5.

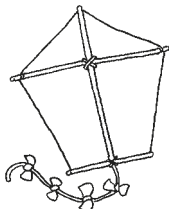

Name _____

Say each picture name. Write the letter that stands for the sound at the beginning of its name.

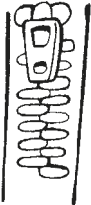
1.  _____

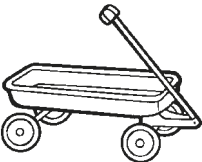
2.  _____

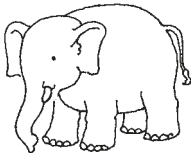
3.  _____

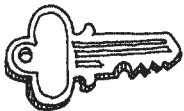
4.  _____

5.  _____



I am Ed.

I like



watermelon

I Like

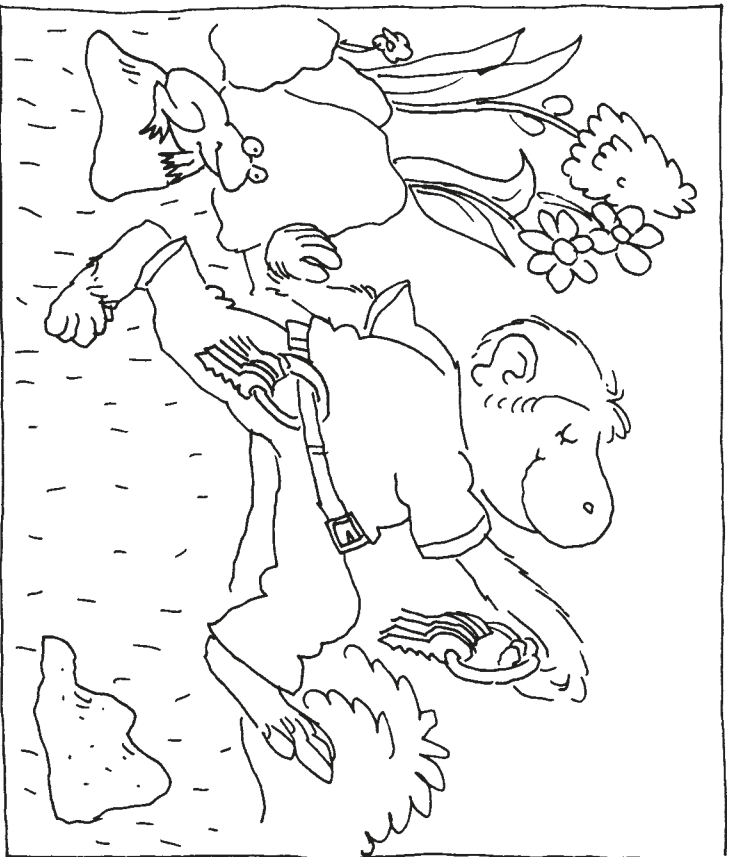

I am Ed.

I like



keys



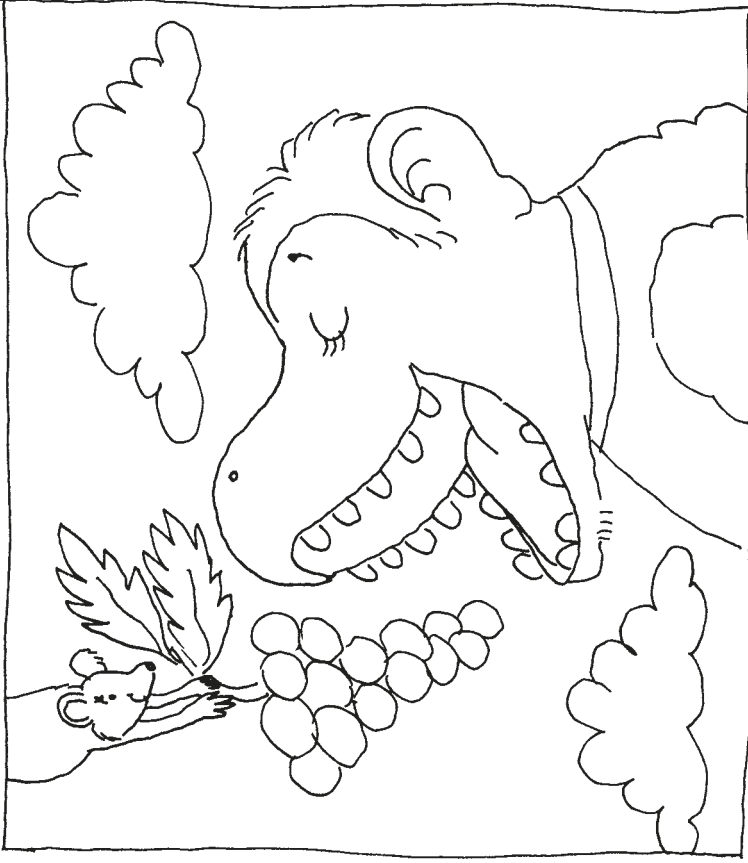

I am Ed.

I like  .
grapes

Comprehension: What does Ed like to eat?

3



I am Ed.

I like  .
zebras

Phonics: Find something in the story that rhymes with **sees**. Circle it.

2

Name _____

A. Say the name of the picture. Listen to the beginning sound. Then write the letter.

1.

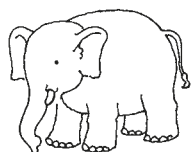

e _____

2.

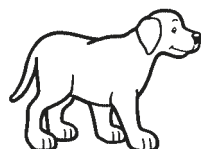

d _____

B. Blend the sounds and say the word. Write the word.

1.

Ed



Name _____

Blend the sounds and say the word. Write the word.

1. **Ed**





2. **bed**



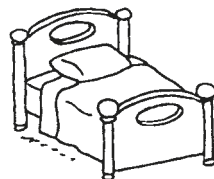

3. **red**



4. **fed**



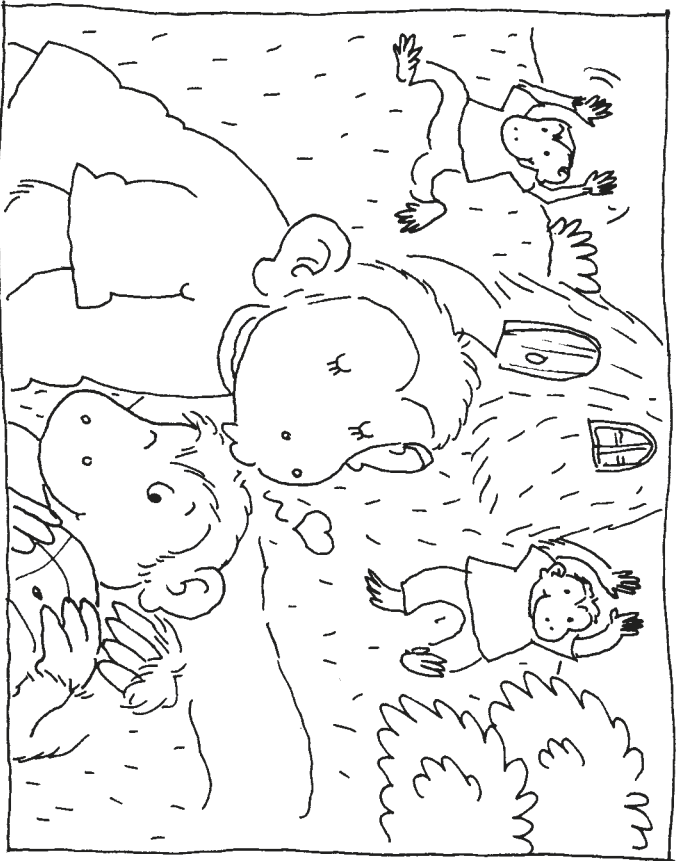



I am Ed.

I can  kiss.

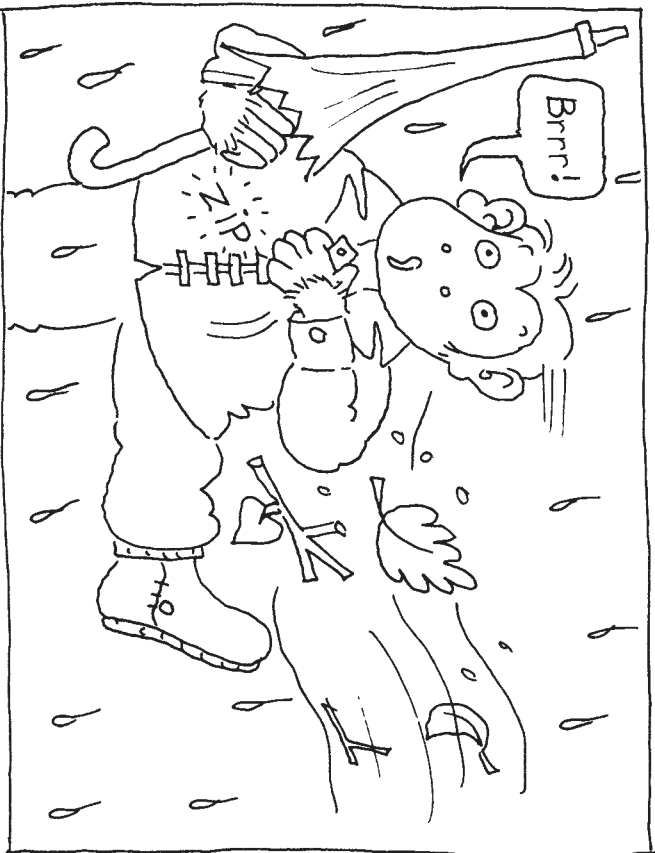
I Can



I am Ed.

I can  zip.

High-Frequency Words:
Circle the word can in
the story.



At Home: Ask your
child to read the
book aloud to you.

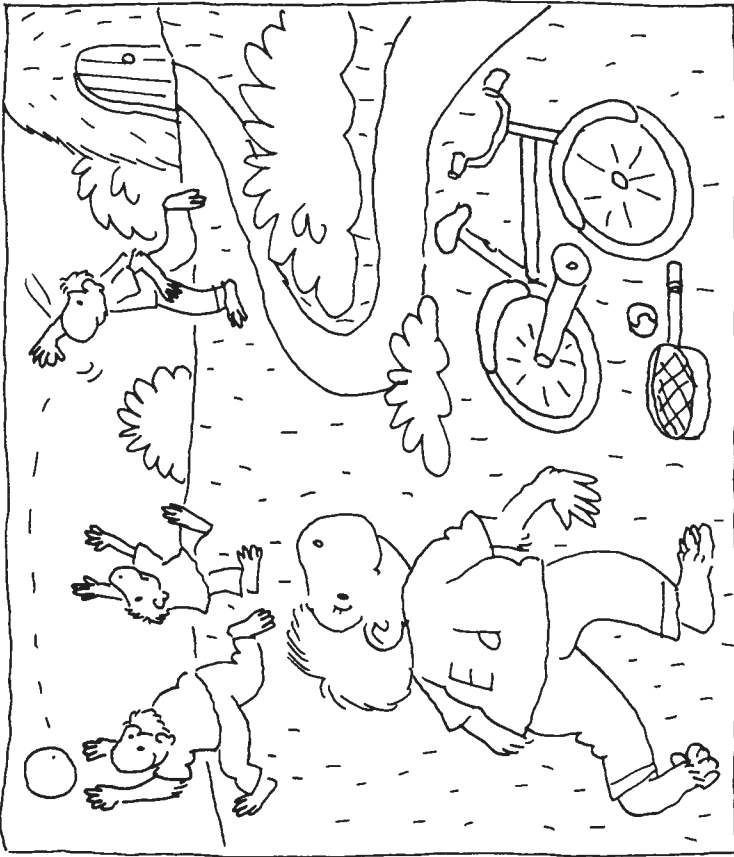

I am Ed.

I can  walk

Phonics: Circle the words that begin with k.

2

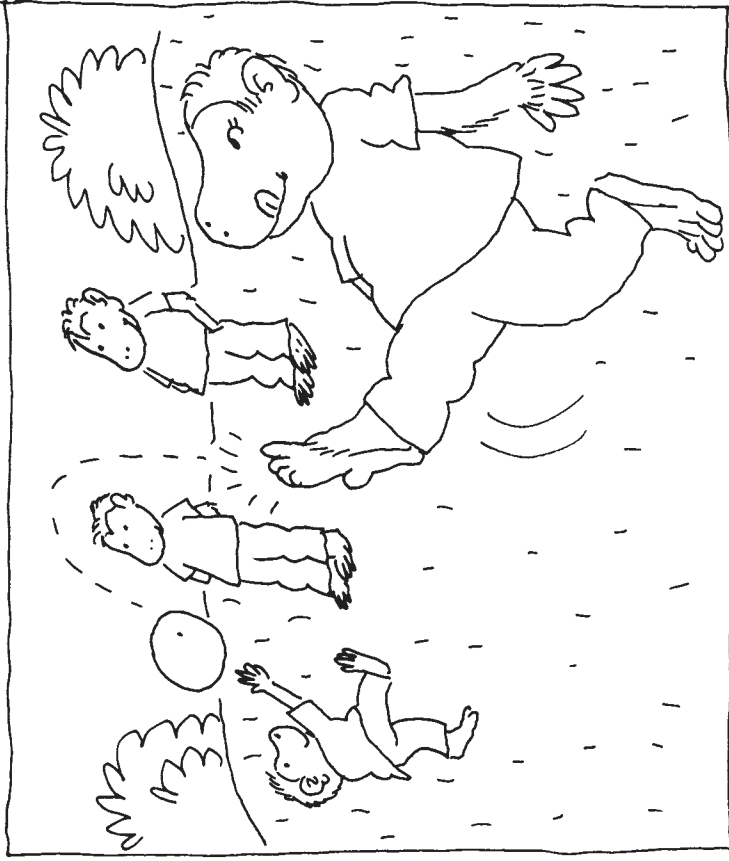

I am Ed.

I can  kick

Comprehension: What is Ed playing?

3



A  can go up.
yo-yo

High-Frequency Words:
Circle the word go in
the story.



At Home: Ask your
child to read the
book aloud to you.

Go Up

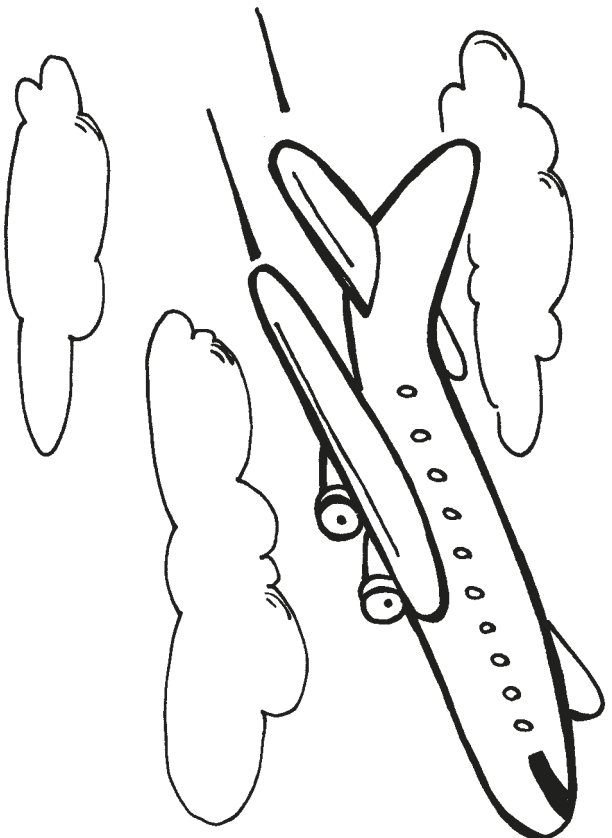

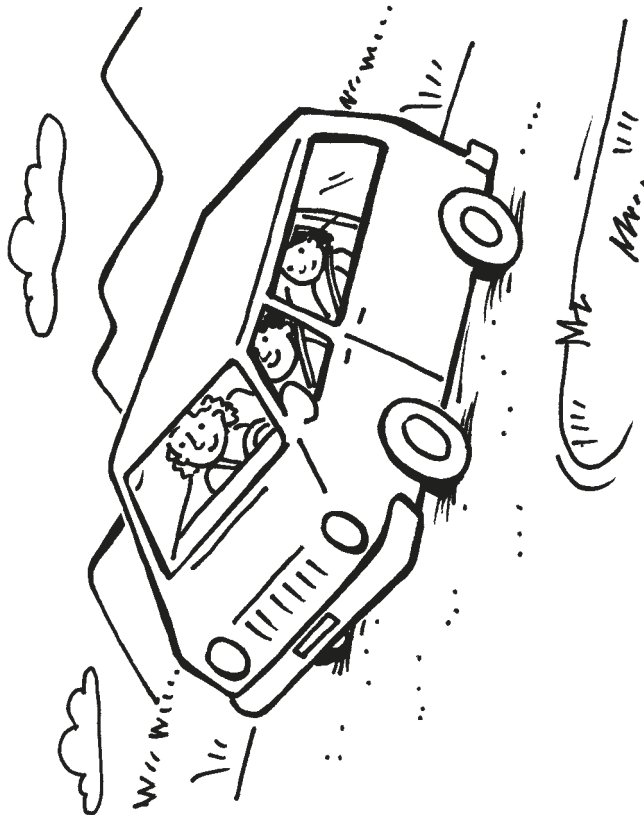

A  can go up.
jet

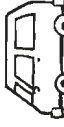

A  can go up.
van

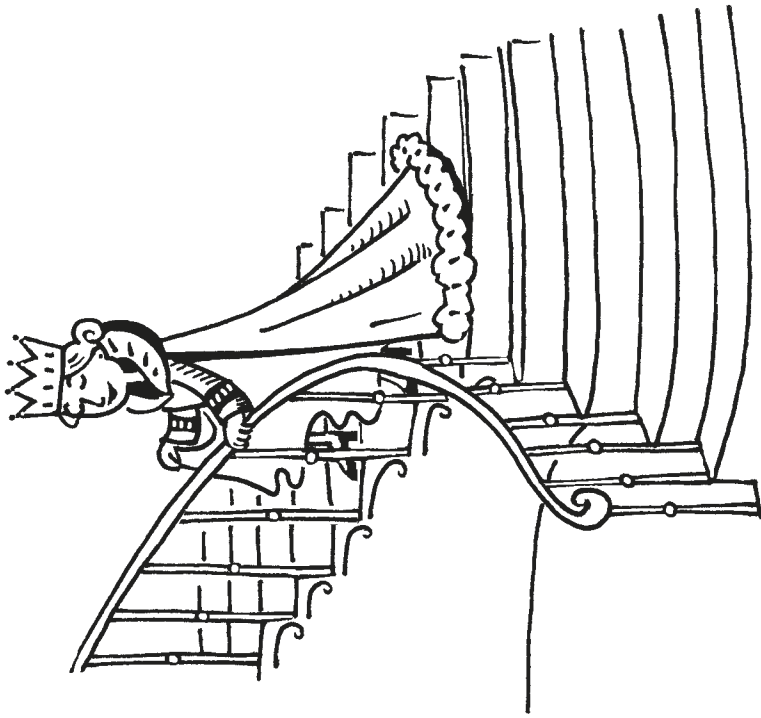
Phonics: Find something in the story that rhymes with **green**. Circle it.



A  can go up.
queen

Comprehension: How does the queen go up?

Name _____

A. Say each picture name. Write the letter that stands for the sound at the beginning of its name.

1.



2.

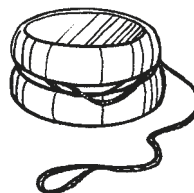

3.



4.

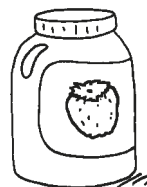

5.



6.

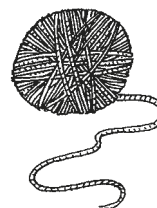

B. Say each picture name. Write the letter that stands for the sound at the end of its name.

1.



2.



Name _____

A. Say the name of the picture. Listen to the beginning sound. Then write the letter.

1.

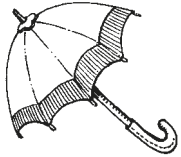

2.

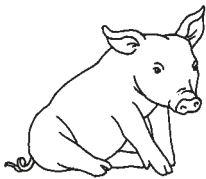

B. Blend the sounds and say the word. Write the word.

1.





I can
juggle .

Can you?



I can
jump .

Can you?



Can You?



I can  .
yell

Can you?

Phonics: Find two words in the story that begin with j. Underline them.

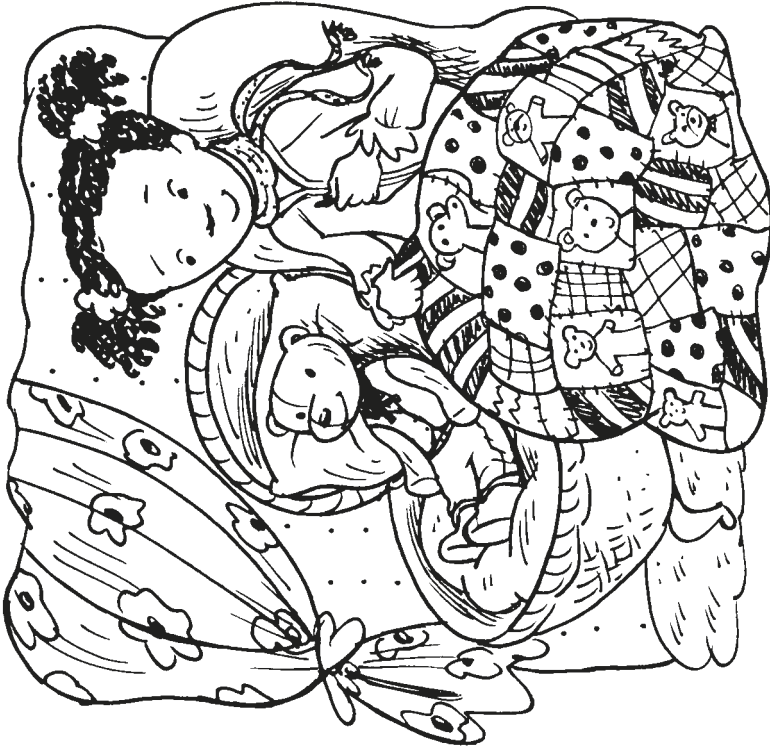













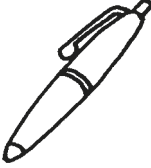

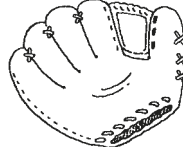
I can  .
quilt

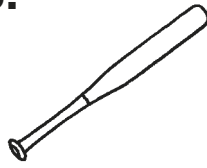
Can you?

Comprehension: Who is the girl making a quilt for?

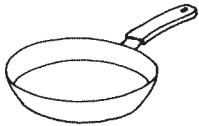
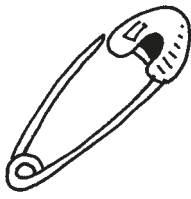
Name _____

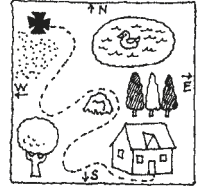
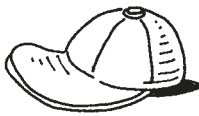
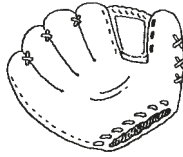
Say the name of each picture. Circle the picture whose name rhymes with the first picture.

<p>1.</p> 			
<p>2.</p> 			
<p>3.</p> 			
<p>4.</p> 			
<p>5.</p> 			

Name _____



cat

Say each picture name. Write a next to the picture if its name has the a sound as in “cat.”

1.



2.



3.

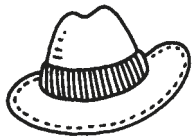

4.



5.



6.

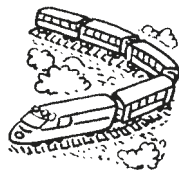

7.

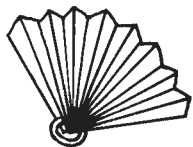

8.

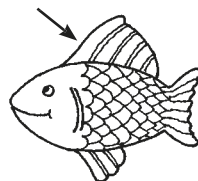

Name _____

A. Read the words in the box. Write one word on each line.

jump and not I

1. _____

2. _____

3. _____

4. _____

B. Use a word from the box to finish each sentence.

1. Pam can _____ .



2. Pam and _____ can jump.

3. Pam ran _____ ran.



4. Pam can _____ nap.

Name _____

The **characters** are the people or animals in the story.
The **setting** is where the story takes place.

As you read “Sam Can Nap,” fill in the Character and Setting Chart.

Setting	What the Characters Do There

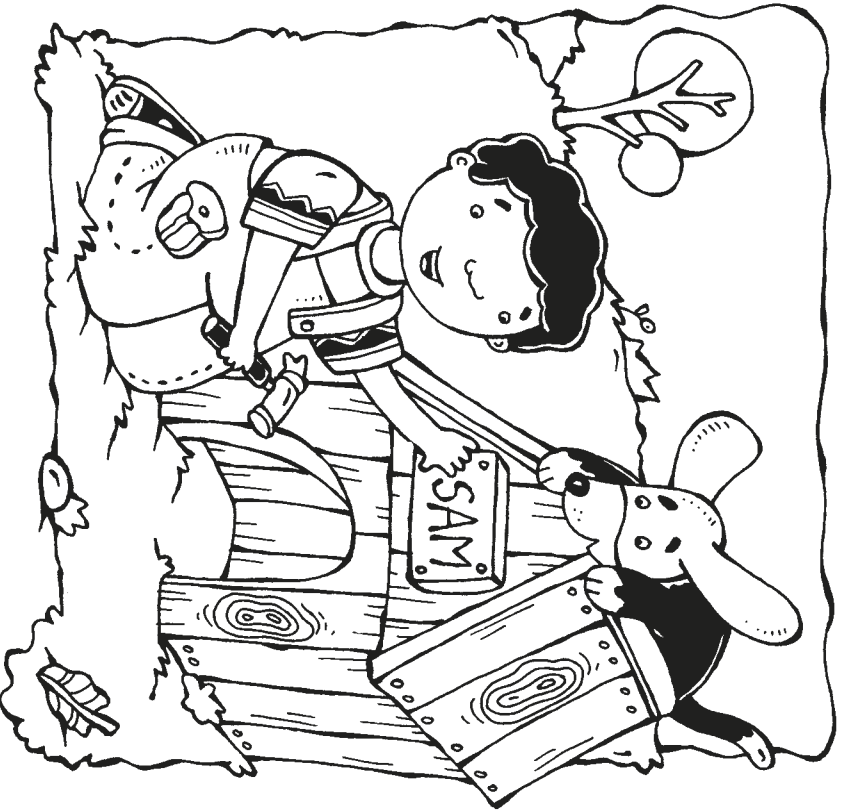

Sam can jump!

High-Frequency Words:

Circle the words not and

jump in the story.

4



At Home: Ask your child to read the book aloud to you.

© Macmillan/McGraw-Hill

Can Sam Tap?

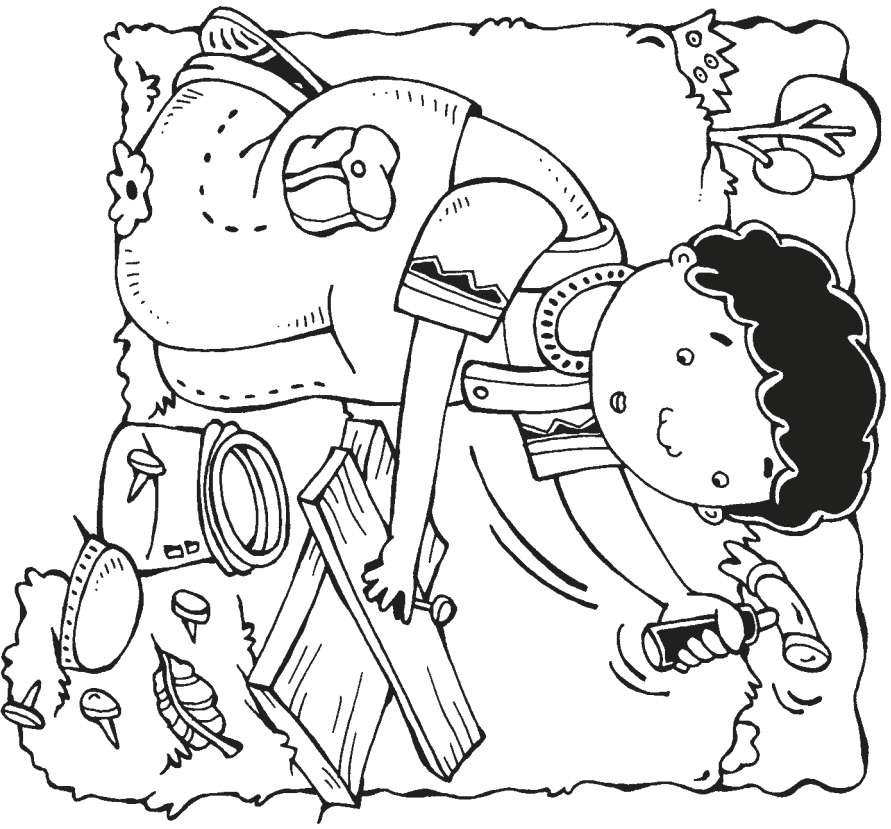

Tap, tap! Tap, tap!



I can tap, tap, tap.

Phonics: Circle the words that rhyme with cap.

2

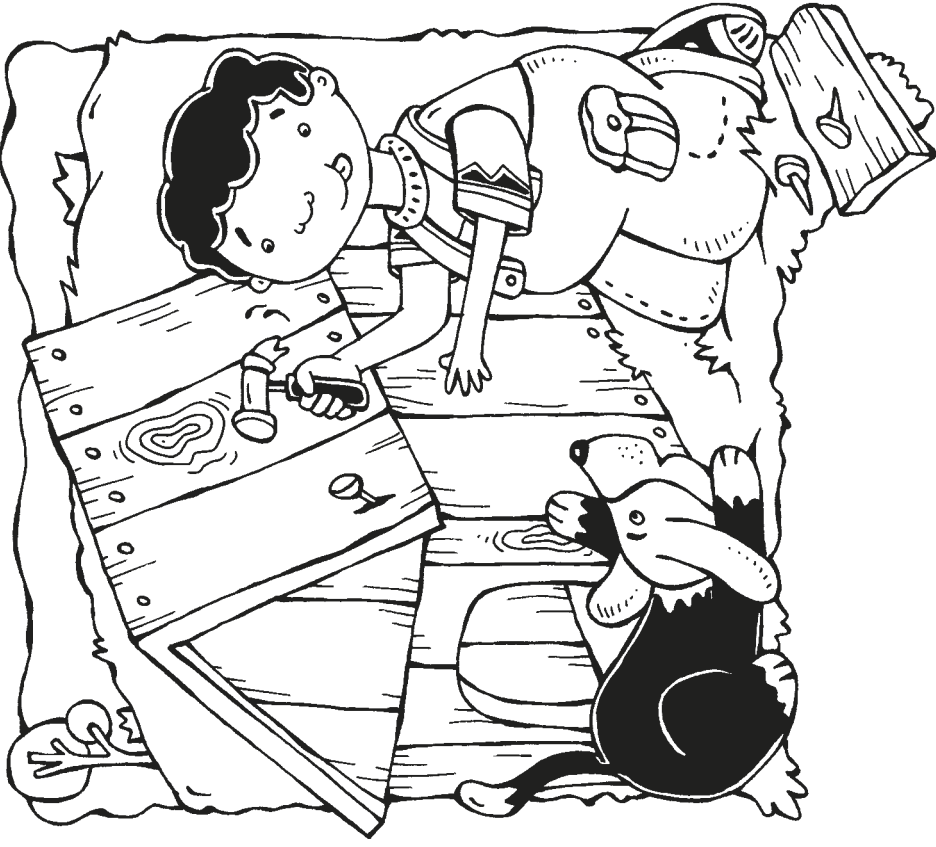











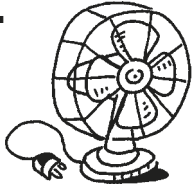

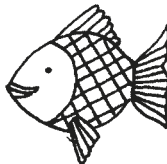
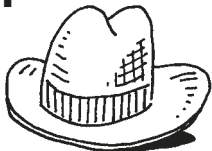



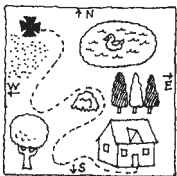

Sam can not tap.

Comprehension: Why can't Sam tap?

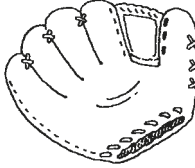
3

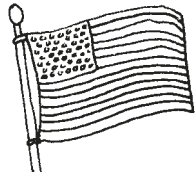
Name _____

Say the name of each picture. Circle the picture whose name rhymes with the first picture.





<p>1.</p> 			
<p>2.</p> 			
<p>3.</p> 			
<p>4.</p> 			
<p>5.</p> 			

Name _____



hat

Say the name of each picture. Use the letters to write each picture name.

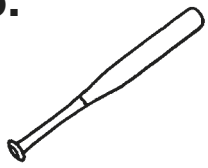
<p>a p</p>	<p>1.  p <input type="text"/> <input type="text"/></p>
<p>a n</p>	<p>2.  n <input type="text"/> <input type="text"/></p>
<p>a g</p>	<p>3.  t <input type="text"/> <input type="text"/></p>
<p>a t</p>	<p>4.  b <input type="text"/> <input type="text"/></p>
<p>a g</p>	<p>5.  b <input type="text"/> <input type="text"/></p>

Name _____

**Circle the word that completes each sentence.
Then write the word on the line.**

1. Can _____ nap?
we too

2. Sam ran _____.
up go

3. Sam and I can _____ .
go hat

4. Dan can jump, _____ .
tag too

Name _____

Sequence is what happens first, next, and last in a story.

As you read “At Bat,” fill in the Sequence Chart.

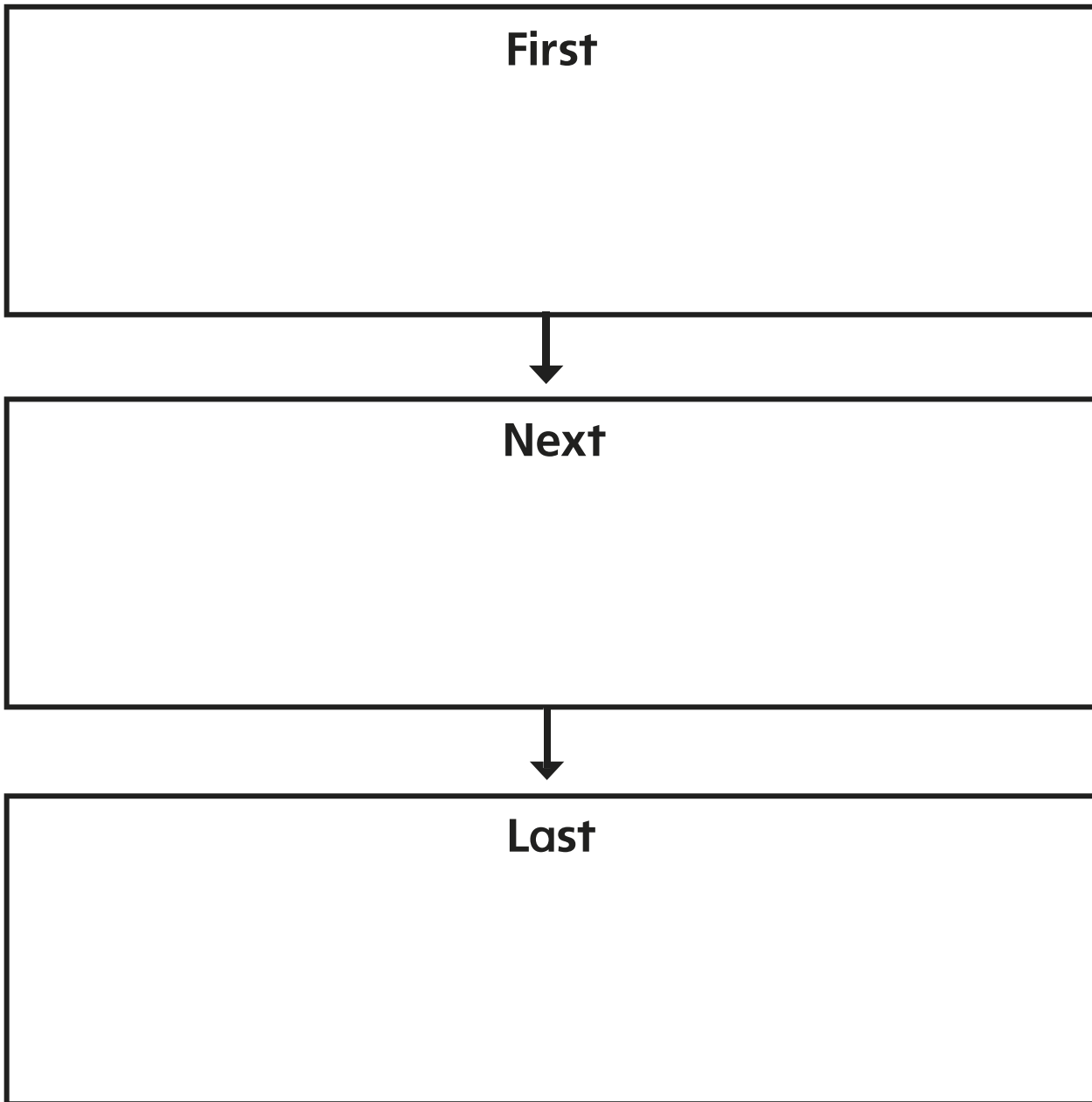

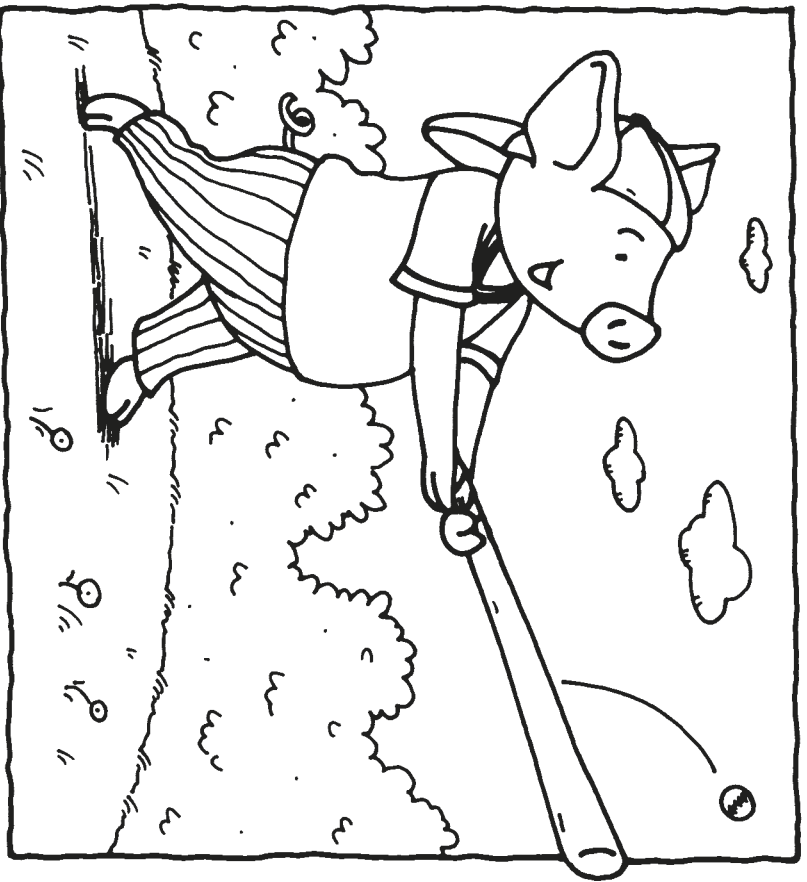

Sam can. Go, Sam!

Can Sam Bat?

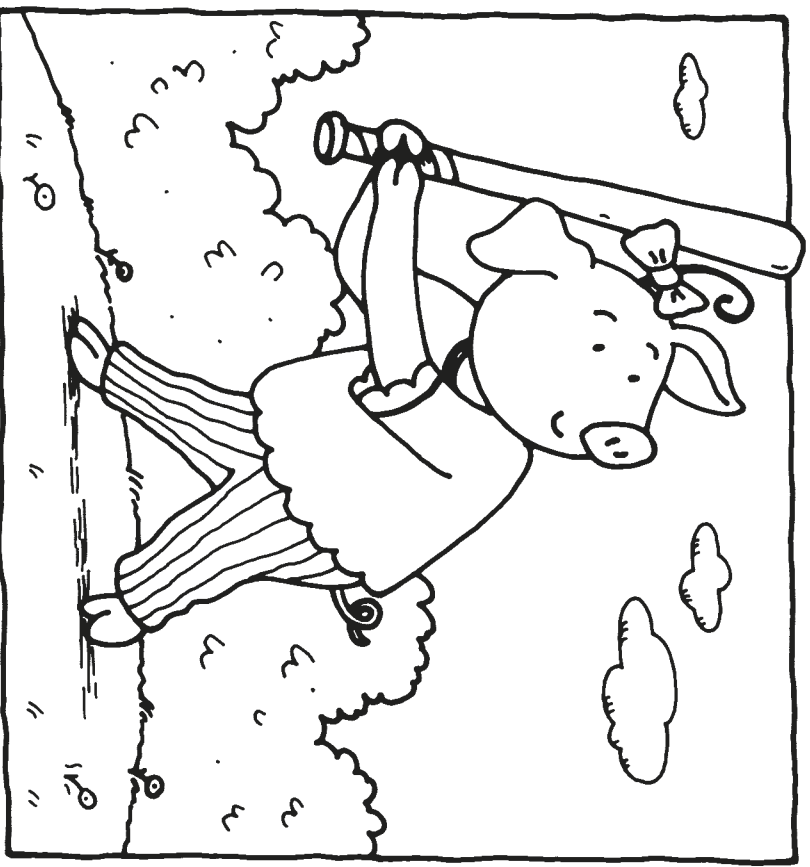

Pam can bat.





Nan can bat, too.

Phonics: Circle the words in the story that rhyme with **sat**.

2

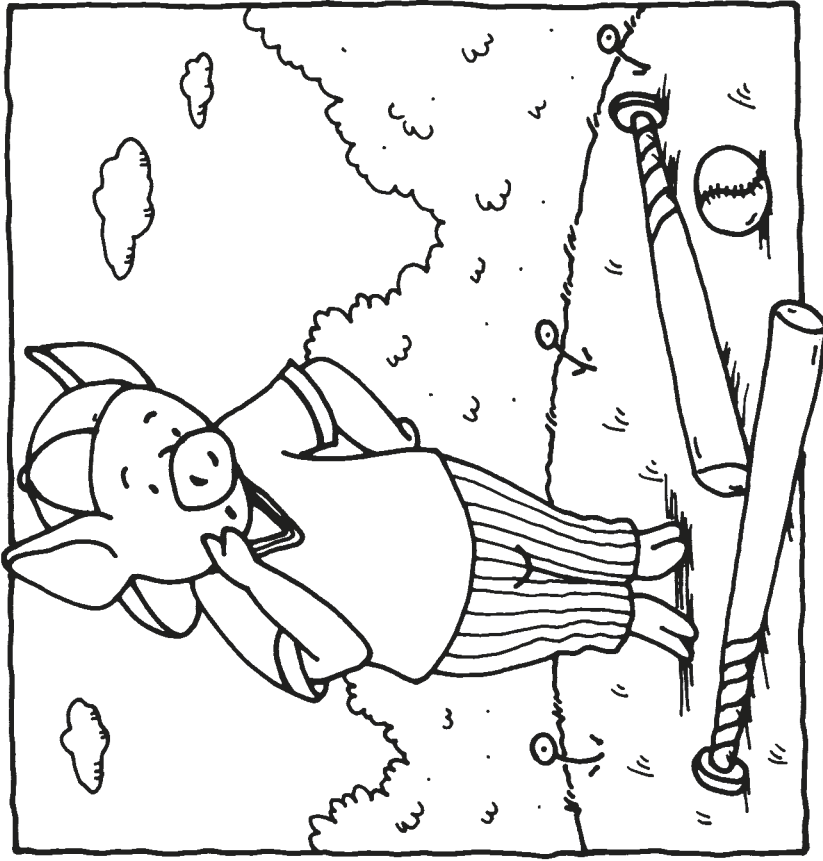











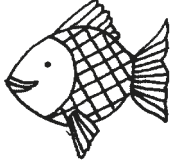
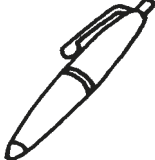
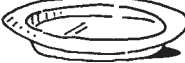

Can Sam?

Comprehension: Who bats last?

3

Name _____

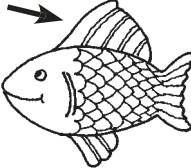
Say the name of each picture. Circle the picture whose name rhymes with the first picture.

1. 			
2. 			
3. 			
4. 			

Name _____



pig

Say the name of each picture. Write the picture name on the line. Circle the letter that stands for the i sound as in “pig.”

lip

zip

pin

fin

dig

kick

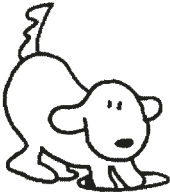
1.  _____

2.  _____

3.  _____

4.  _____

5.  _____

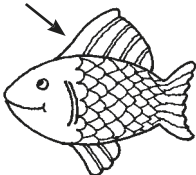
6.  _____

Name _____

A. Read the words in the box. Write one word on each line.

play run the be

- | | |
|--------------------------------|--------------------------------|
| 1. _____
- - - - -
_____ | 2. _____
- - - - -
_____ |
| 3. _____
- - - - -
_____ | 4. _____
- - - - -
_____ |

B. Use a word from the box to finish each sentence.

1. Jim has _____ bat.

2. Kim and Tim can _____ .

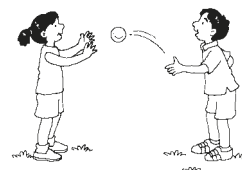

3. We can _____ up.

4. Jan will _____ six.



Name _____

Sequence is what happens first, next, and last in a story.

As you read “Big Max,” fill in the Sequence Chart.

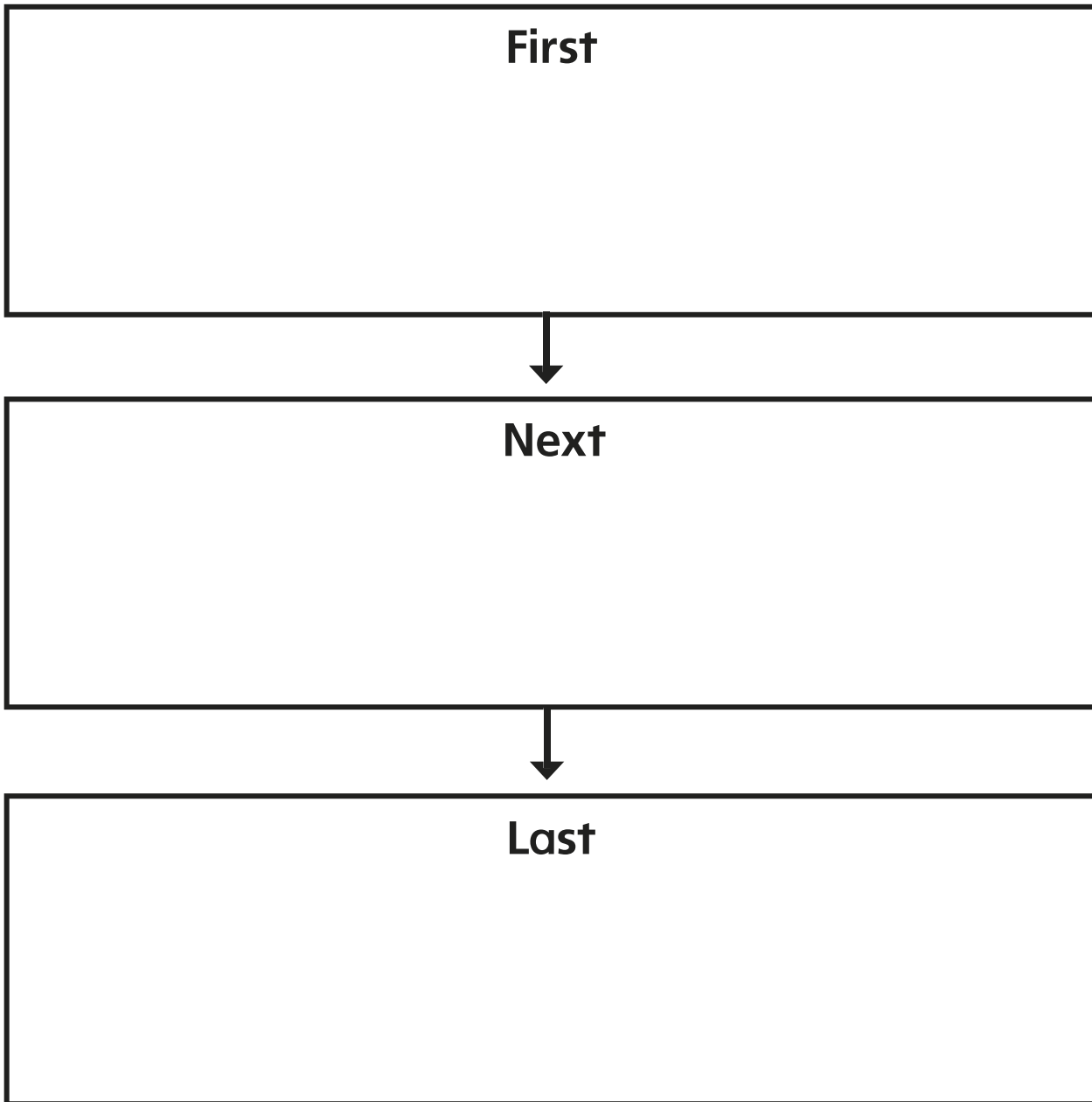



Six kits can.

Six Kits

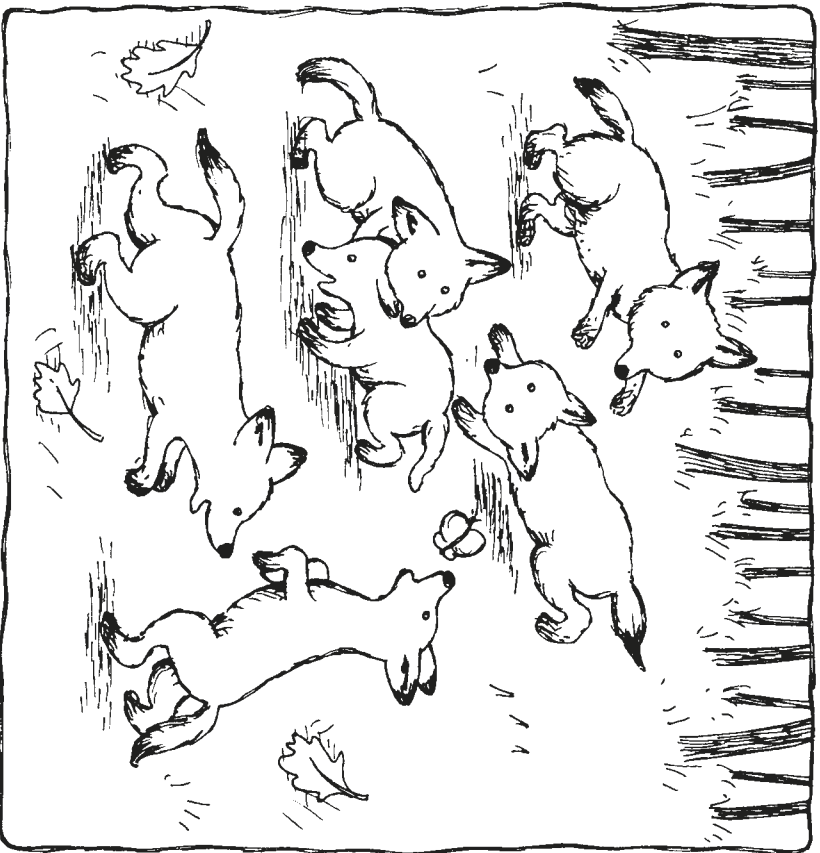

Six kits run.

4

High-Frequency Words:
Circle the words run and
be in the story.



At Home: Ask your
child to read the
book aloud to you.

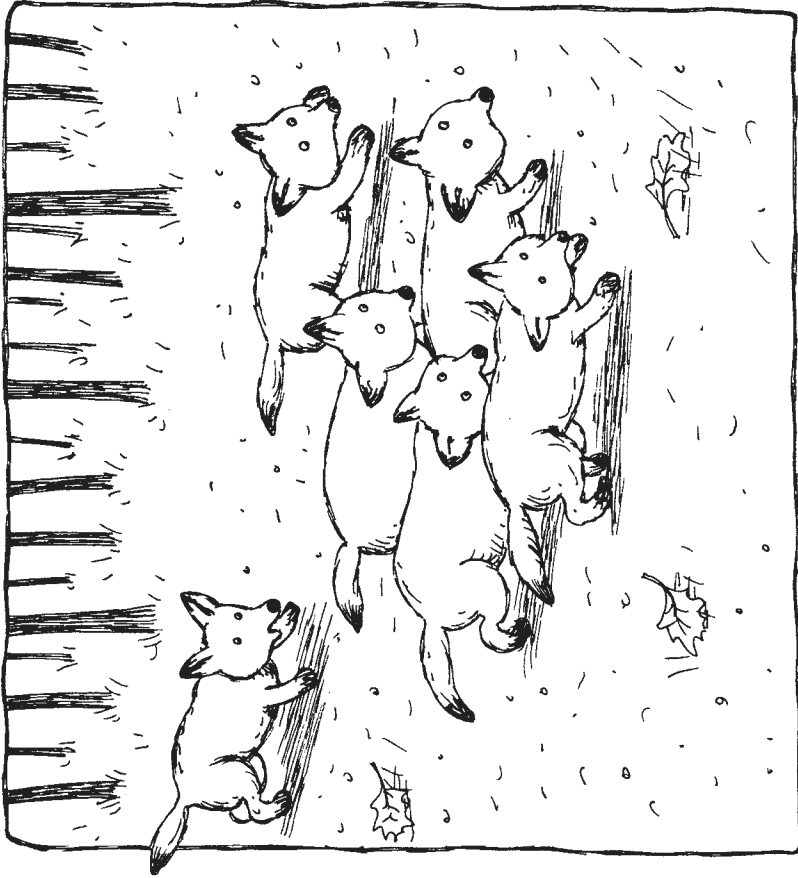

Kits can be quick!

Phonics: Circle the words with short i.

2

Can six kits fit?

Comprehension: What do the kits do after they play?





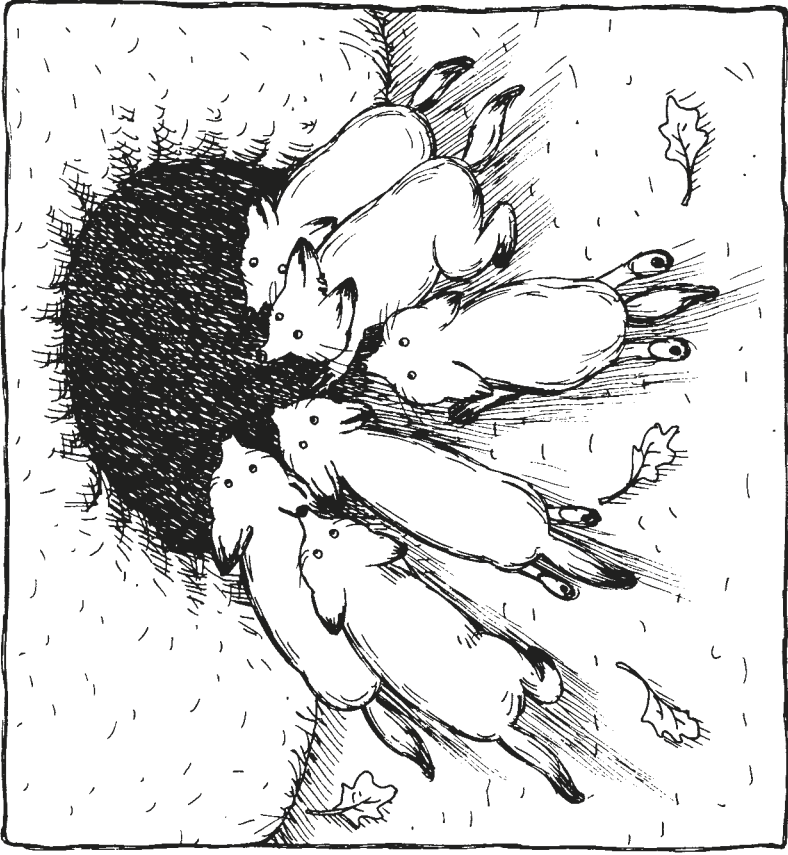





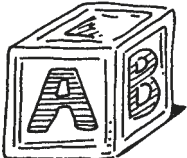

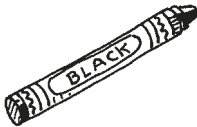
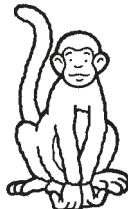
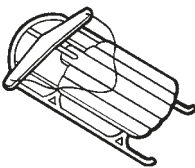

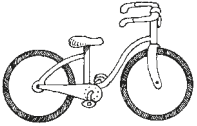

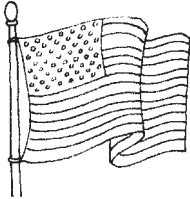
© Macmillan/McGraw-Hill

3

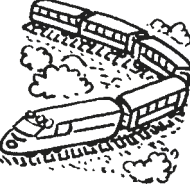

Name _____

Say the name of each picture. Circle the picture whose name begins with the same sounds as the first picture.

1. 			
2. 			
3. 			
4. 			
5. 			

Name _____

A. Say the name of each picture. Write the picture name from the box on the line. Circle the letters that make the beginning sounds.

flag

clam

slip

flip

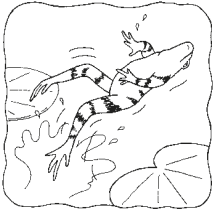
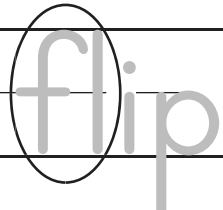
1.  

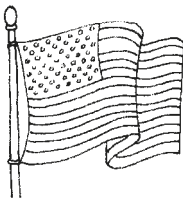
2.  _____

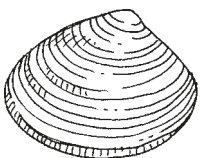
3.  _____

4.  _____

B. Read the words. Circle the two letters that stand for the beginning sounds in each word.

black

slim

click

slap

clap

flick

clam

flag

flip

Name _____

A. Read the words in the box. Write one word on each line.

come

good

do

a

1. _____

_____2. _____

_____3. _____

_____4. _____

_____**B. Use a word from the box to finish each sentence.**

1. Flag is a _____ cat.

2. Rick can pack _____ bag.

3. Kit can _____ it.

4. Min can _____, too.

Name _____

Stories have a **beginning**, a **middle**, and an **end**.

As you read “Flag Can Do It,” fill in the Plot Chart.

Beginning



Middle



End



Bill is good, too!

High-Frequency Words:
Circle the word good in
the story.



At Home: Ask your
child to read the
book aloud to you.

4

© Macmillan/McGraw-Hill

Slip, Flip!



Slip, flip!
Bill slips.

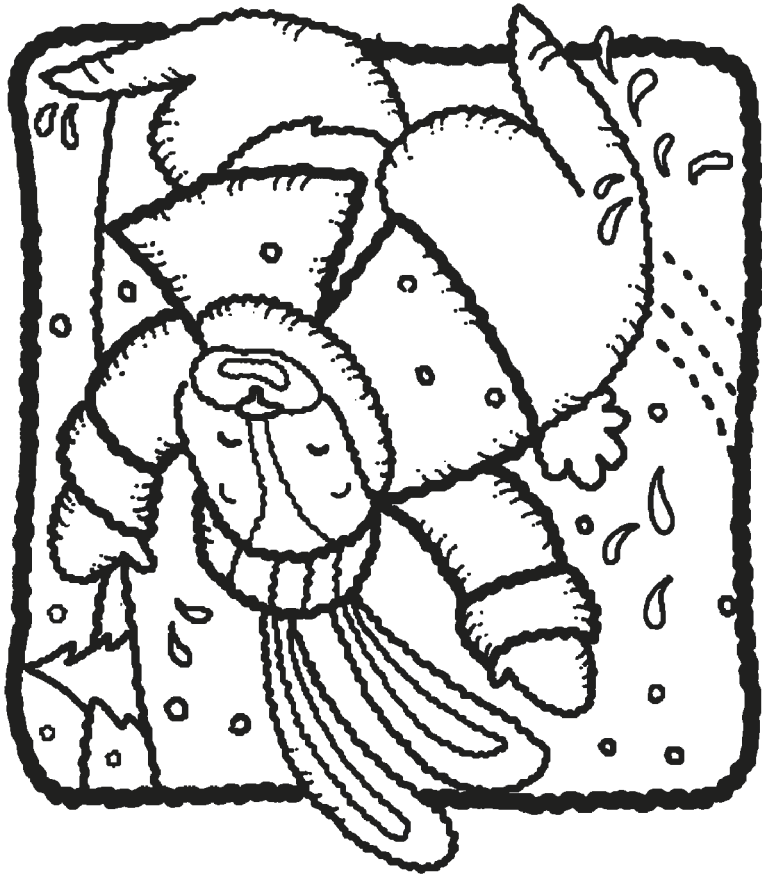

Slip, flip!
Jill flips.

Phonics: Circle words in the story with
sl and fl.

2











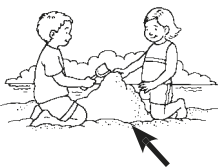
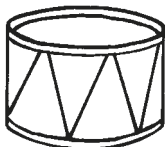

Bill is good.

Comprehension: What is Bill and Jill's
problem?

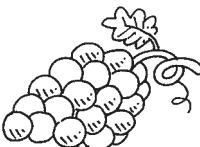
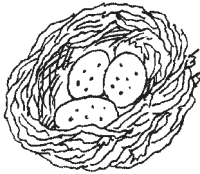
3

Name _____

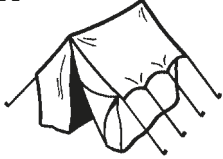
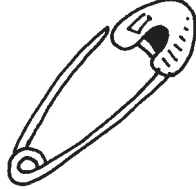
Say the name of each picture. Circle the picture whose name ends with the same sounds as the first picture.

<p>1.</p> 			
<p>2.</p> 			
<p>3.</p> 			
<p>4.</p> 			

Name _____



hand



vest





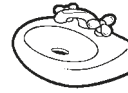

ant

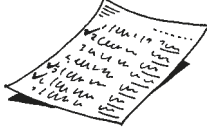

sink

Say the name of each picture. Write the missing letters to finish the picture name. Circle the letters that make the final sounds.

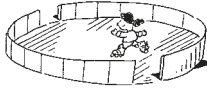
<p>1.</p>  <p>i <u>nk</u></p>	<p>2.</p>  <p>li _____</p>
<p>3.</p>  <p>ba _____</p>	<p>4.</p>  <p>sa _____</p>
<p>5.</p>  <p>ca _____</p>	<p>6.</p>  <p>ri _____</p>

Name _____

**Circle the word that completes each sentence.
Then write the word on the line.**

1. _____ can cats do?

What I

2. A cat can run _____ fast.

the very

3. _____ cats nap.

Little Play

4. Big cats _____ little cats.

help go

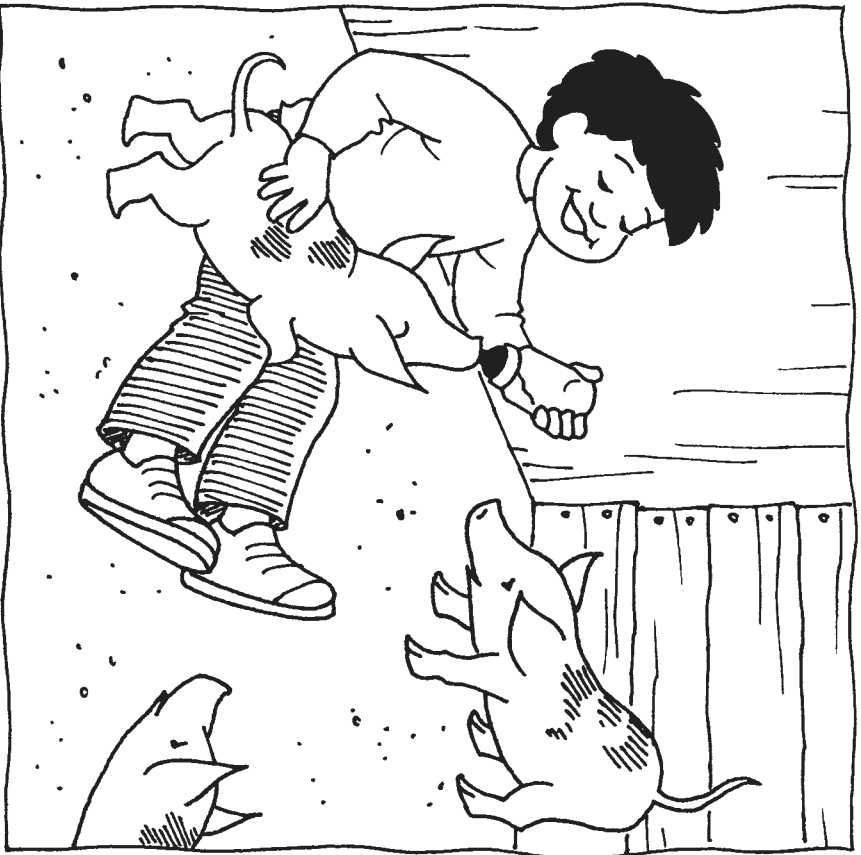

Kids can!
Pigs can sip fast.

Pink Pigs

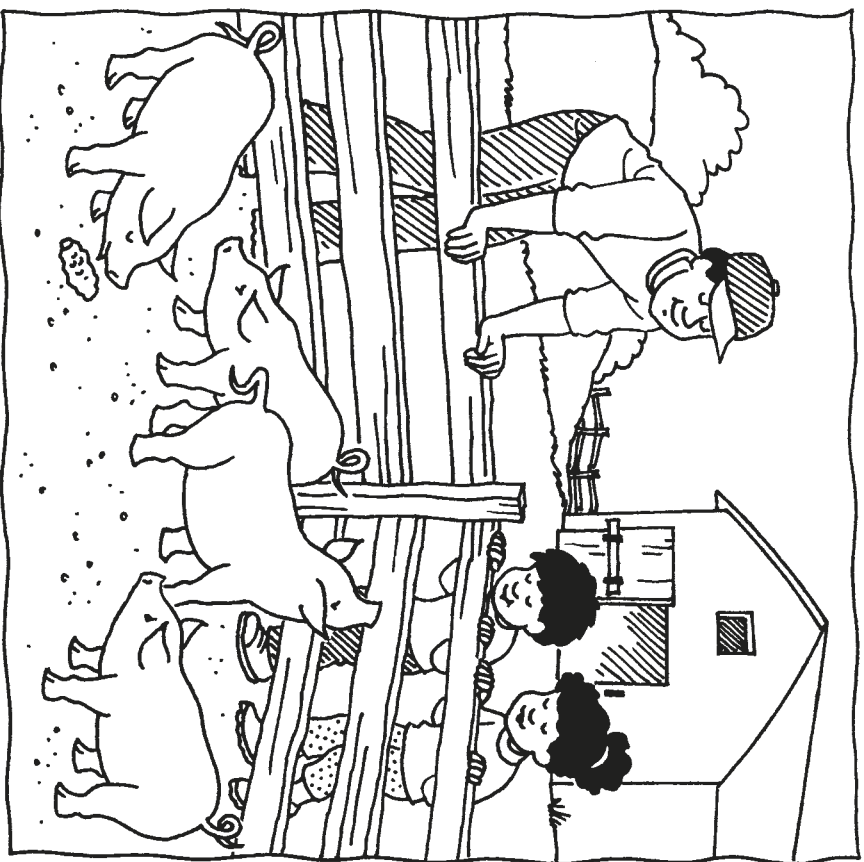

Pigs can be big and fat.

High-Frequency Words:
Circle the words little
and help in the story.



At Home: Ask your
child to read the
book aloud to you.

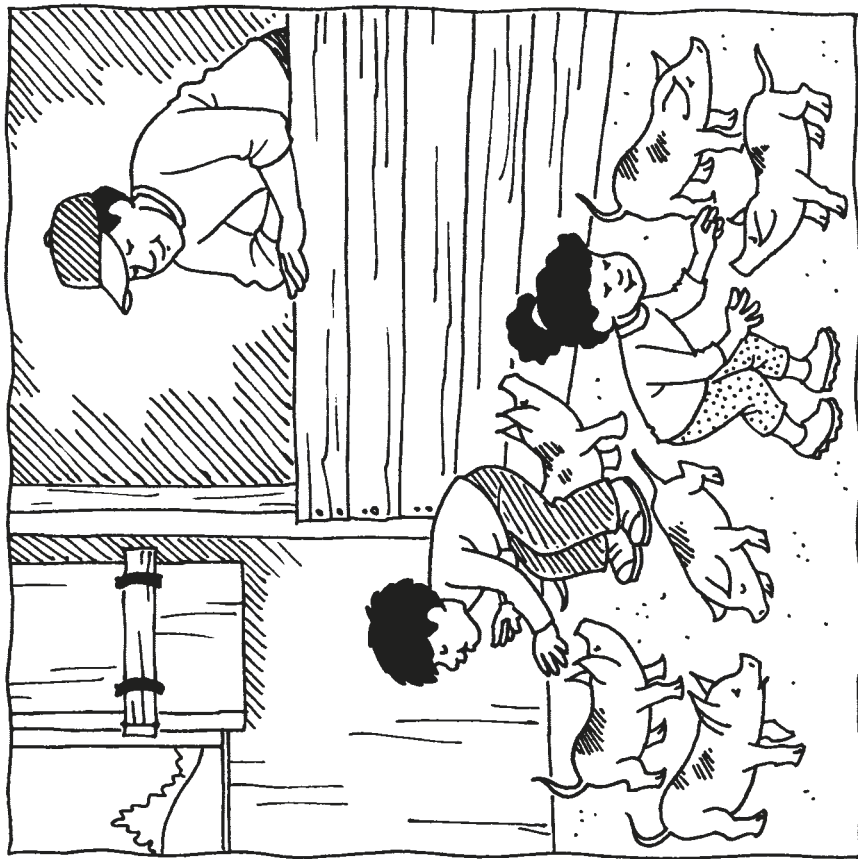

Pigs can be little and pink.

Phonics: Circle the word in the story that ends with **nk**.

2

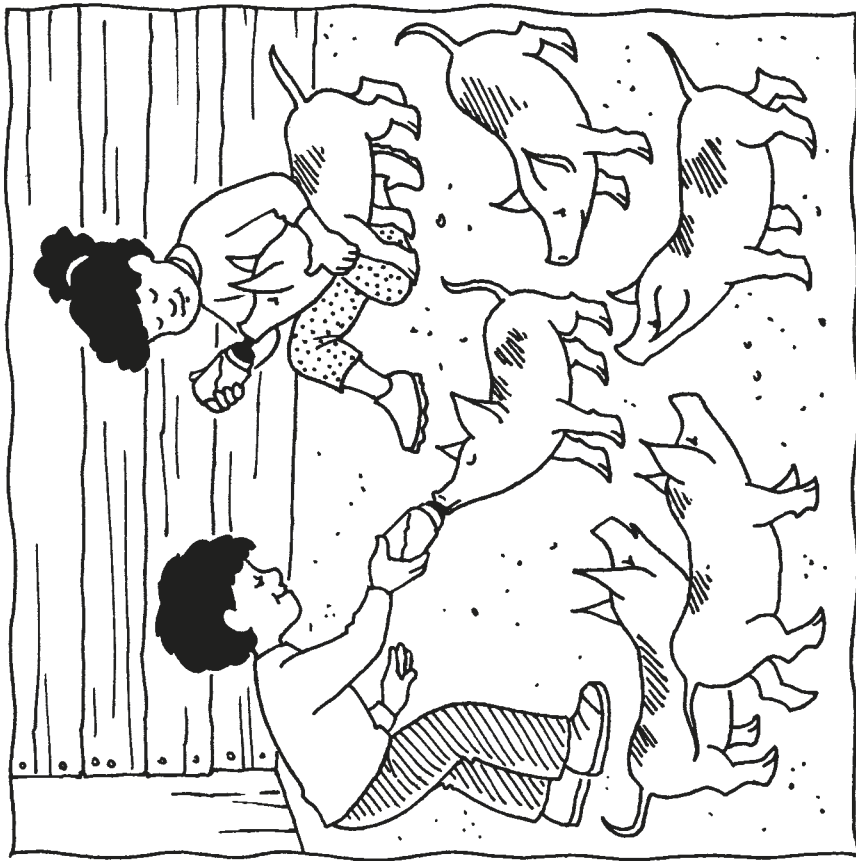













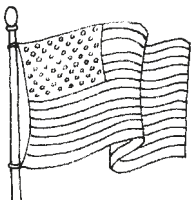

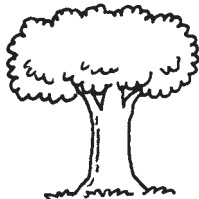

Can kids help pigs?

Comprehension: What do you think the author wants you to know about pigs?

3

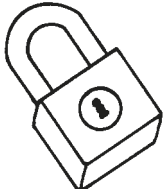
Name _____

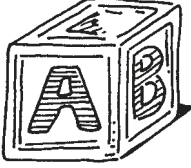

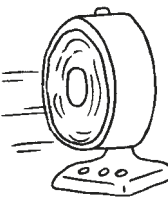
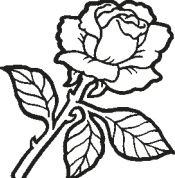
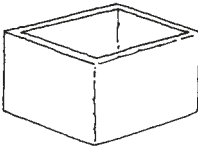
Say the name of each picture. Circle the picture whose name rhymes with the first picture.



1. 			
2. 			
3. 			
4. 			
5. 			

Name _____

Look at each picture. Write the picture name from the box on the line. Circle the letter that makes the short o sound.

jog top sock mop block pop

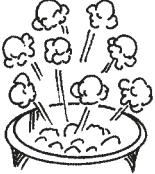
1.   2.  _____

3.  _____ 4.  _____

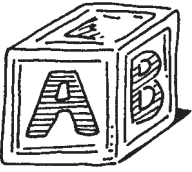
5.  _____ 6.  _____

Name _____

A. Read the words in the box. Write one word on each line.

see

my

they

her

1. _____

2. _____

3. _____

4. _____

B. Use a word from the box to finish each sentence.

1. I _____ the big dog.

2. _____ can play.

3. _____ dog can jog, too.

4. _____ cat is little.

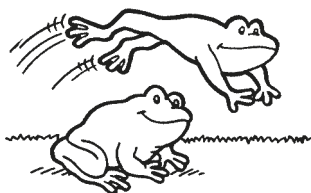

Name _____

The **main idea** is the most important idea in a story.
Details in the story tell more about the main idea.

As you read “My Mom,” fill in the Main Idea and
Details Chart.

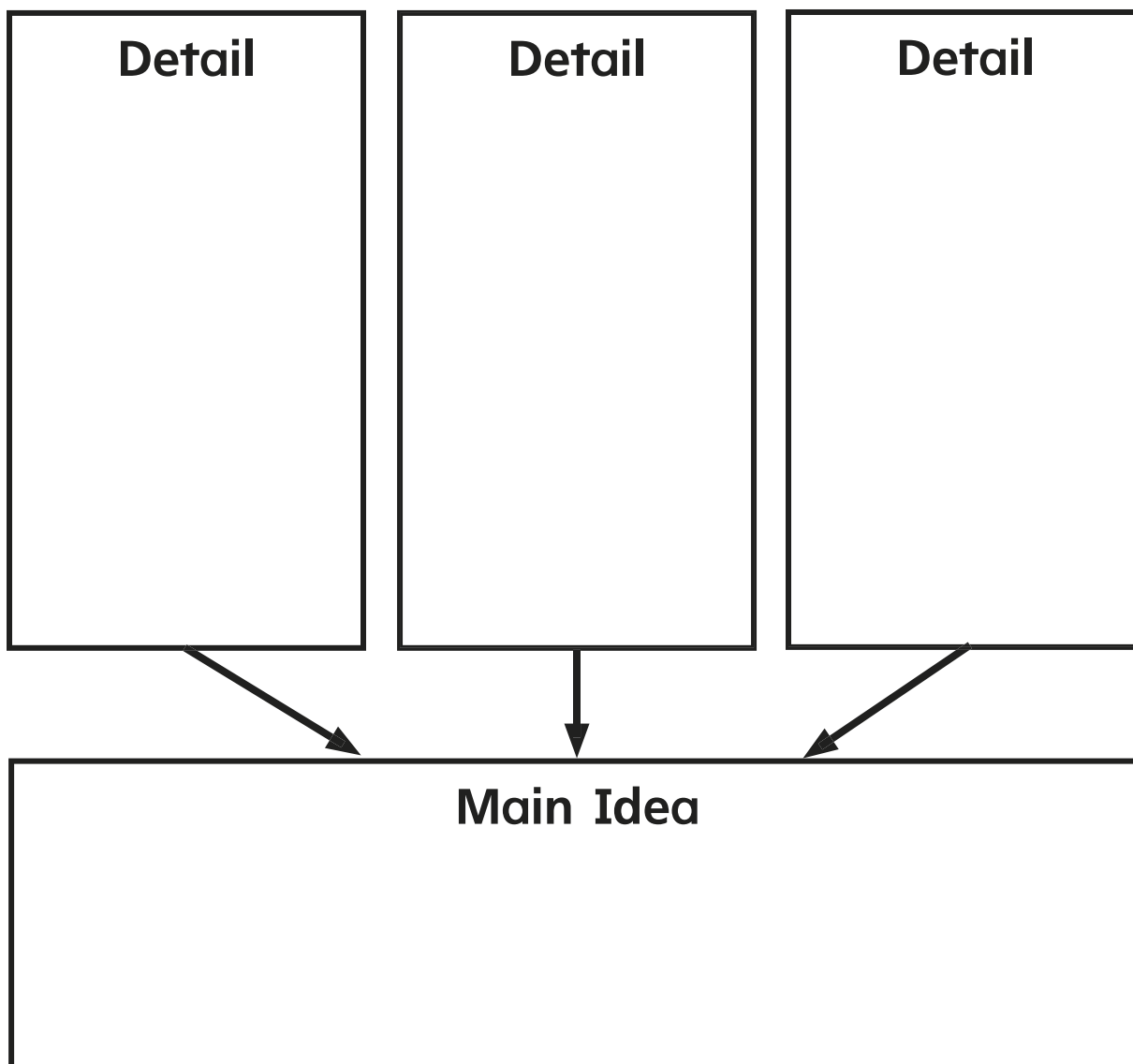



Mom and little fox nap.
They nap in a big log.

Mom Fox



A fox is a good mom.
Mom fox licks her little fox.



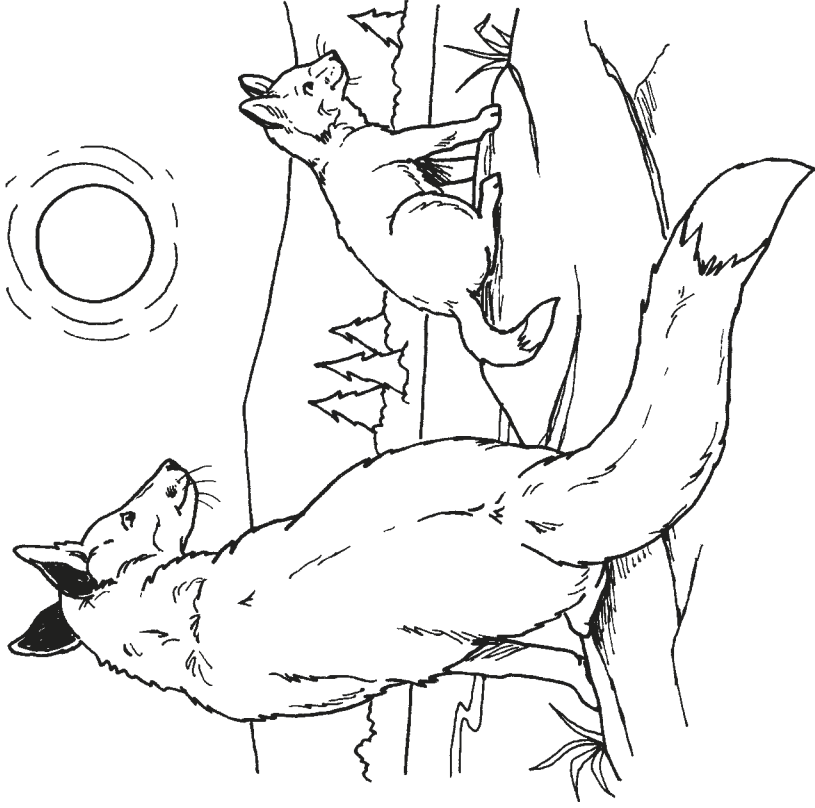

Mom fox sits.
Little fox sits and sits and sits.

Comprehension: What is this book all about?

3











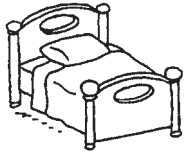
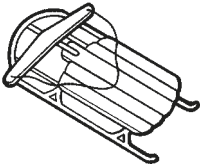
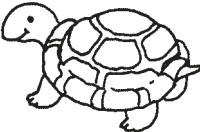

Mom fox hops on a rock.
Little fox hops on a rock.

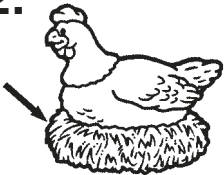
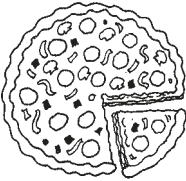
Phonics: Circle the words in the story that rhyme with **sock**.

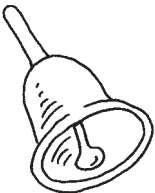
2

Name _____

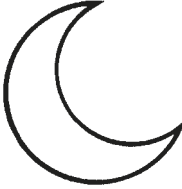
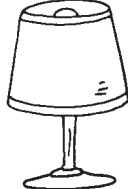
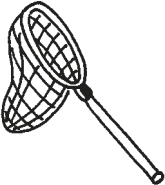
Say the name of each picture. Circle the picture whose name rhymes with the first picture.

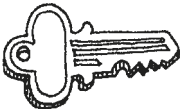

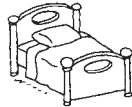

1. 			
2. 			
3. 			
4. 	10		
5. 			

Name _____

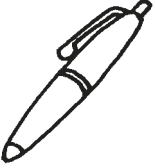
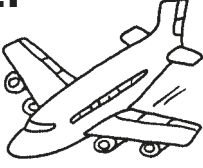

bed

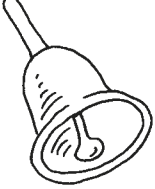
Circle the word that names each picture. Then write the word on the line. Underline the letter that makes the short e sound.

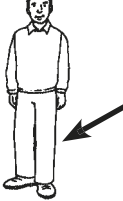
<p>1.  pet pen box</p> <p>_____</p> <p>pen</p> <p>_____</p>	<p>2.  jump vet jet</p> <p>_____</p> <p>_____</p> <p>_____</p>	<p>3.  ten top wet</p> <p>_____</p> <p>_____</p> <p>_____</p>
<p>4.  bag bell bed</p> <p>_____</p> <p>_____</p> <p>_____</p>	<p>5.  van get vet</p> <p>_____</p> <p>_____</p> <p>_____</p>	<p>6.  let pot leg</p> <p>_____</p> <p>_____</p> <p>_____</p>

Name _____

A. Read the words in the box. Write one word on each line.

are

who

look

no

1. _____

2. _____

3. _____

4. _____

B. Use a word from the box to finish each sentence.

1. I _____ at the cats.



2. _____ is in bed?

3. The cats _____ on the mat.

4. Ned has _____ pets.



Name _____

Retelling a story helps you remember the most important parts. You can then share the story with others.

As you read “On the Bed,” fill in the Retelling Chart.

On the Bed

Beginning

1.	→	2.
----	---	----

Middle

3.	→	4.
----	---	----

Ending

5.	→	6.
----	---	----

Rex at the Vet

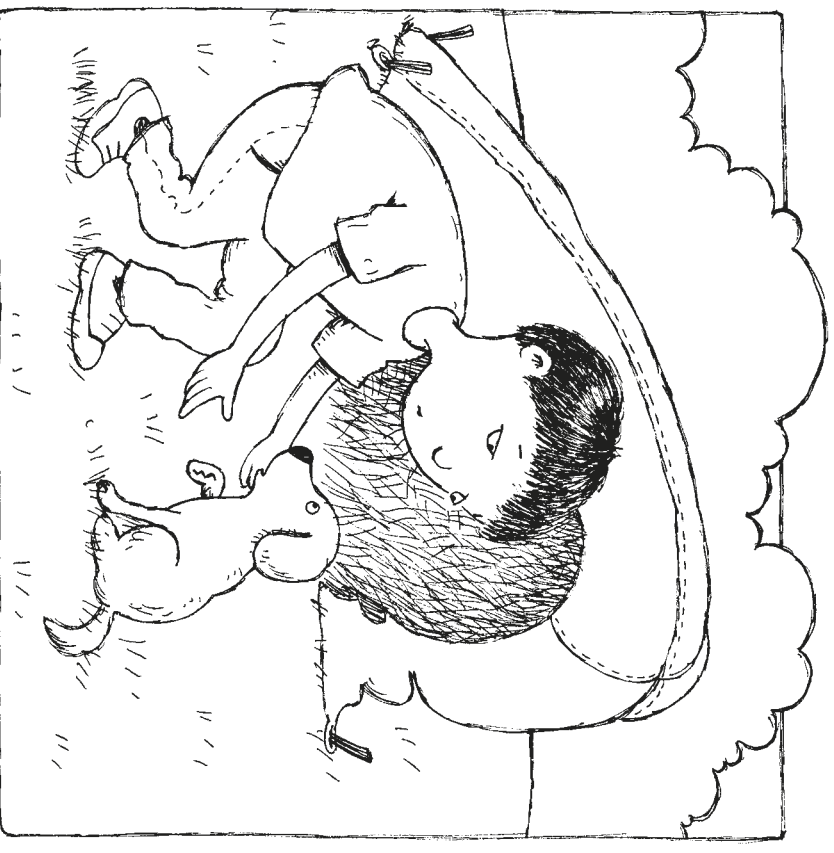

Ed has a pet.
His pet is Rex.
A tent fell on Rex.

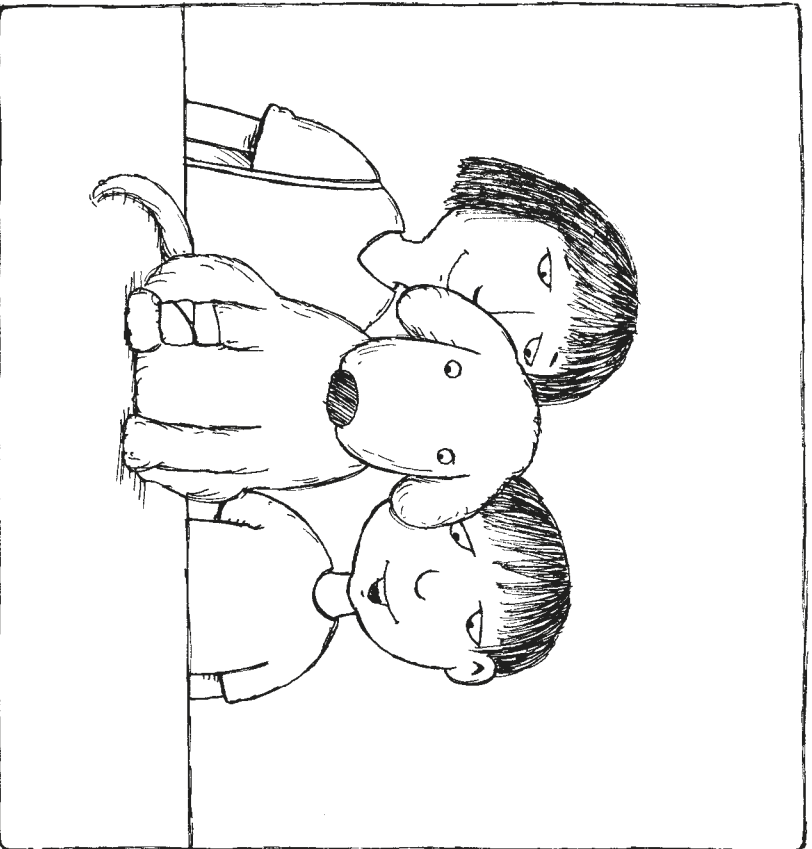

The vet helps Rex get well.

High-Frequency Words:
Circle the words who and
look in the story.



At Home: Ask your
child to read the
book aloud to you.

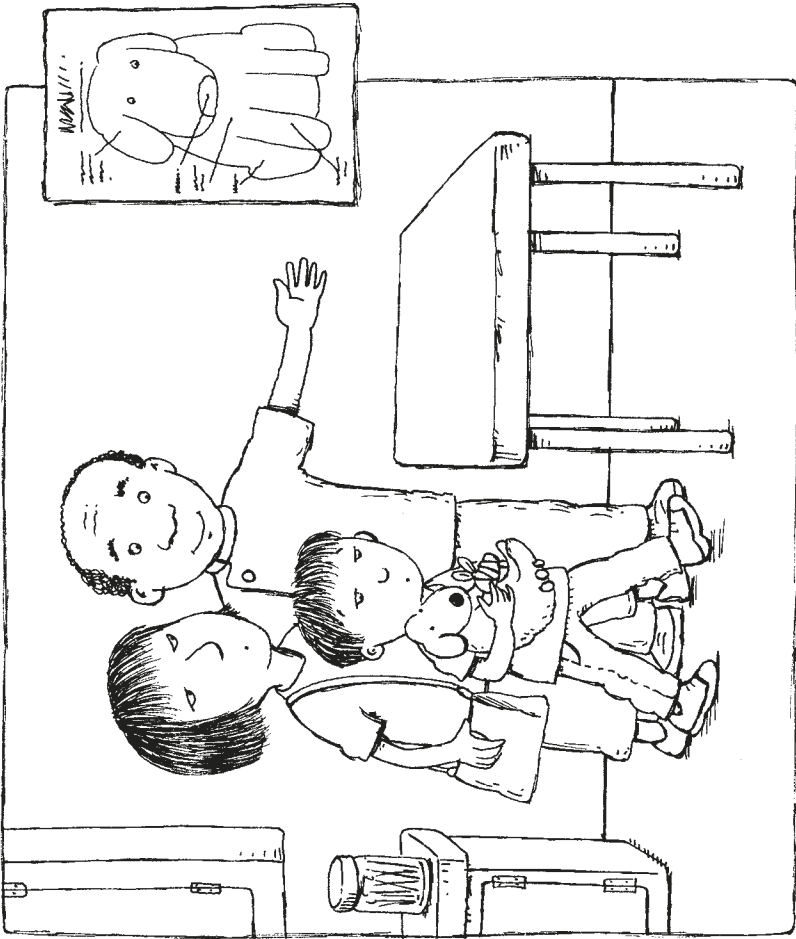

Who will fix his leg?
A vet will fix his leg.

Phonics: Circle the words in the story that rhyme with **let**.

2















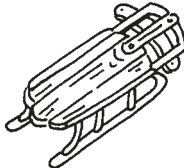
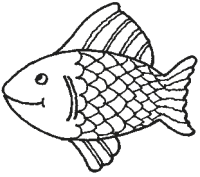

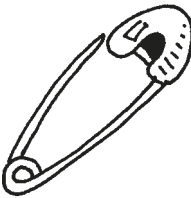
Look at Rex!
Rex licks the vet.

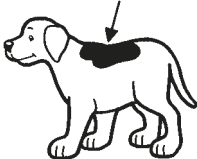
Comprehension: Retell this story in your own words.

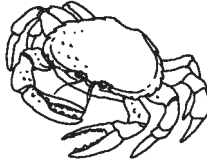
3

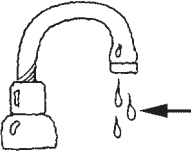
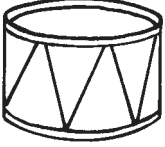
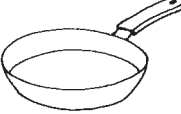
Name _____

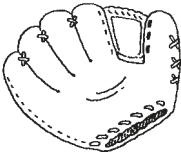
Say the name of each picture. Circle the picture whose name begins with the same sounds as the first picture.

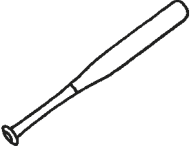
1. 			
2. 			
3. 			
4. 			
5. 			

Name _____

Say each picture name. Write the two letters that stand for the sounds you hear at the beginning of each picture name.

sn

cr

sl

dr

tr

sk

sw

1.

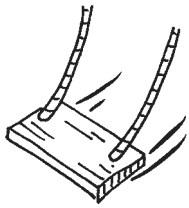

sw

2.



3.



4.

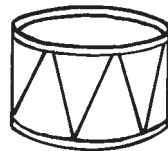

5.



6.

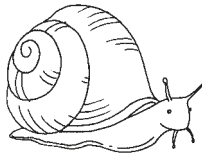

7.



8.



Name _____

A. Read the words in the box. Write one word on each line.

here

for

live

many

1. _____

2. _____

3. _____

4. _____

B. Use a word from the box to finish each sentence.

1. We _____ here.



2. I see _____ cats.

3. We did it _____ mom.



4. Can Ted come _____ ?

Name _____

The **main idea** is the most important idea in a story.
Details in the story tell more about the main idea.

As you read “Kids Can,” fill in the Main Idea and
Details Chart.

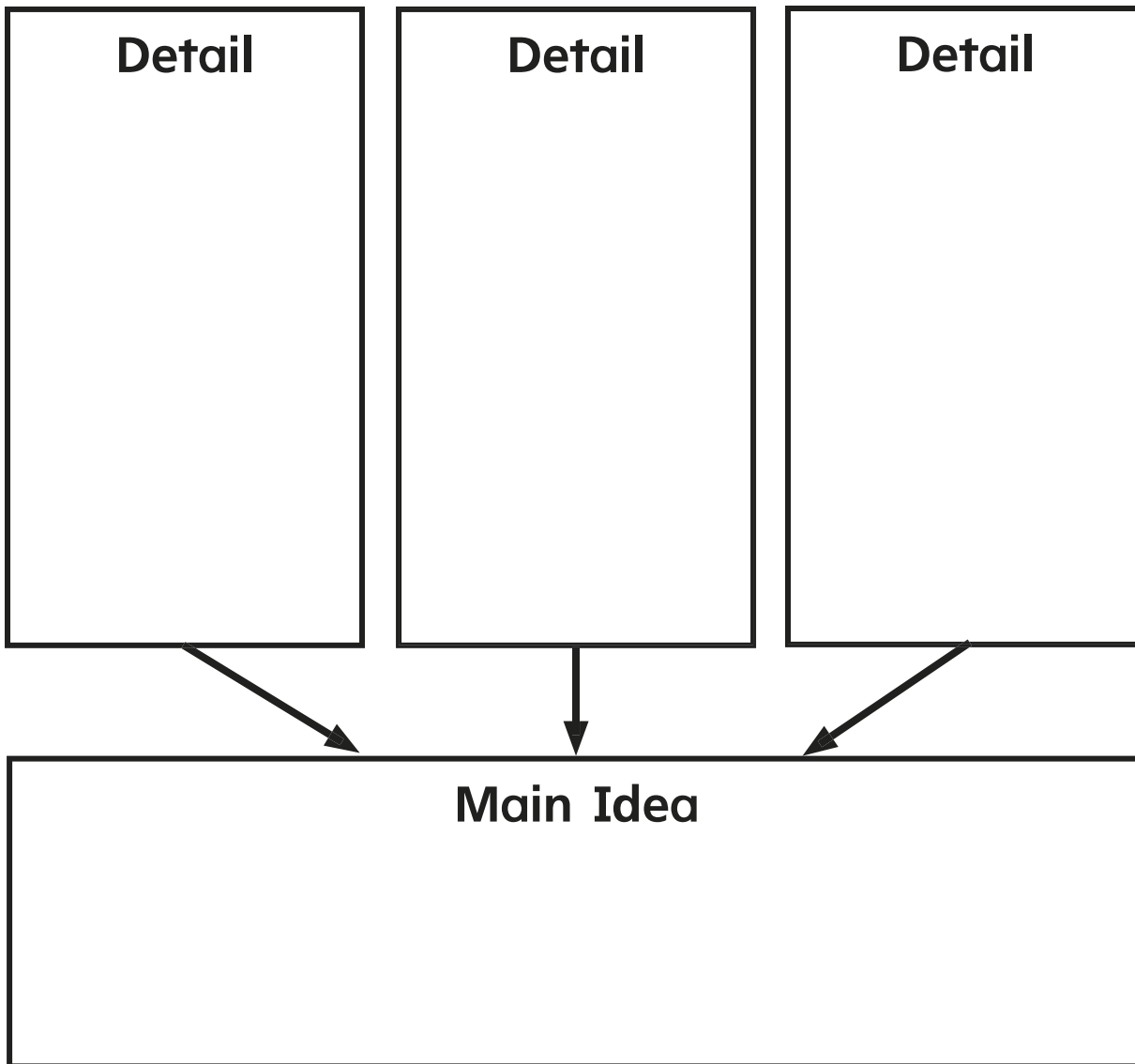

Crabs

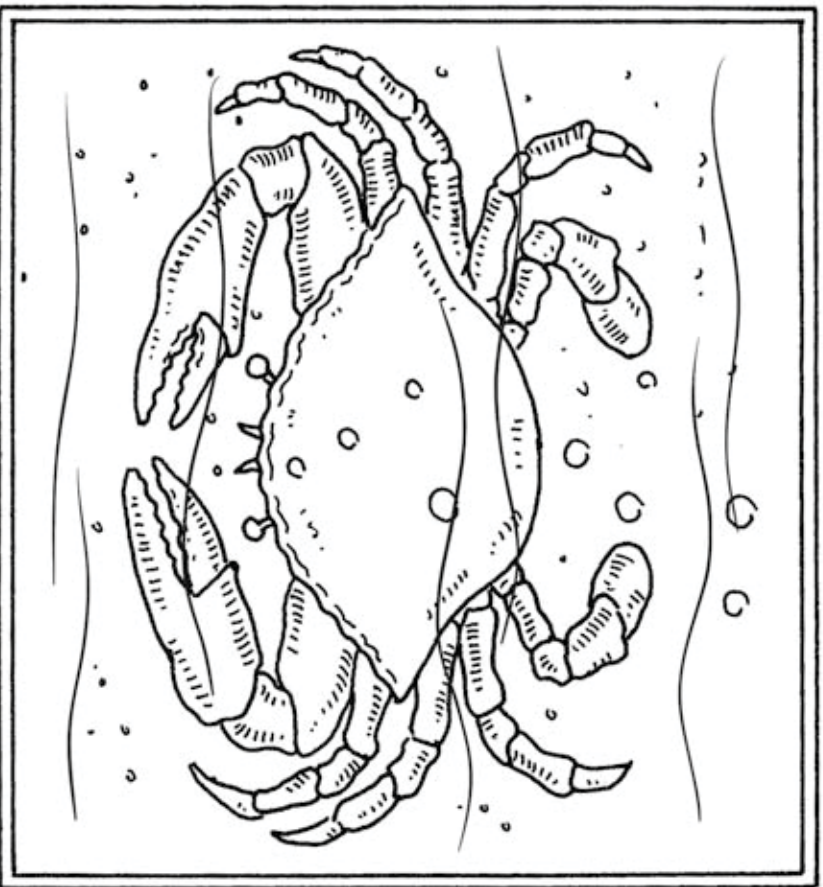

A crab can swim.
It can swim fast!

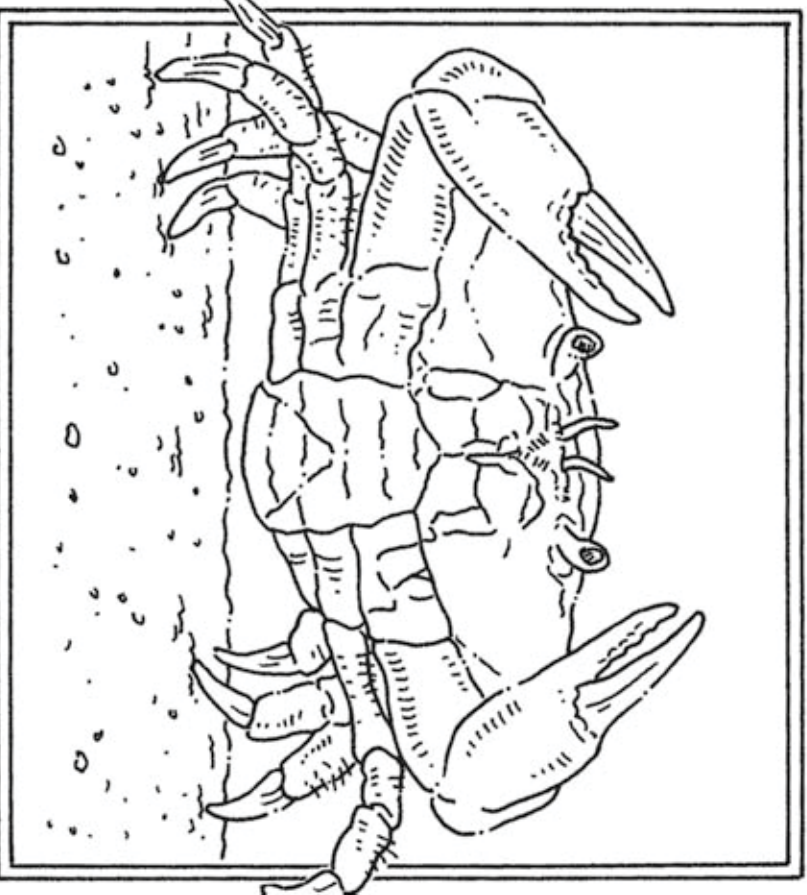

Here is a crab.
It has many legs.

4

High-Frequency Words:
Circle the words here and
many in the story.



At Home: Ask your
child to read the
book aloud to you.

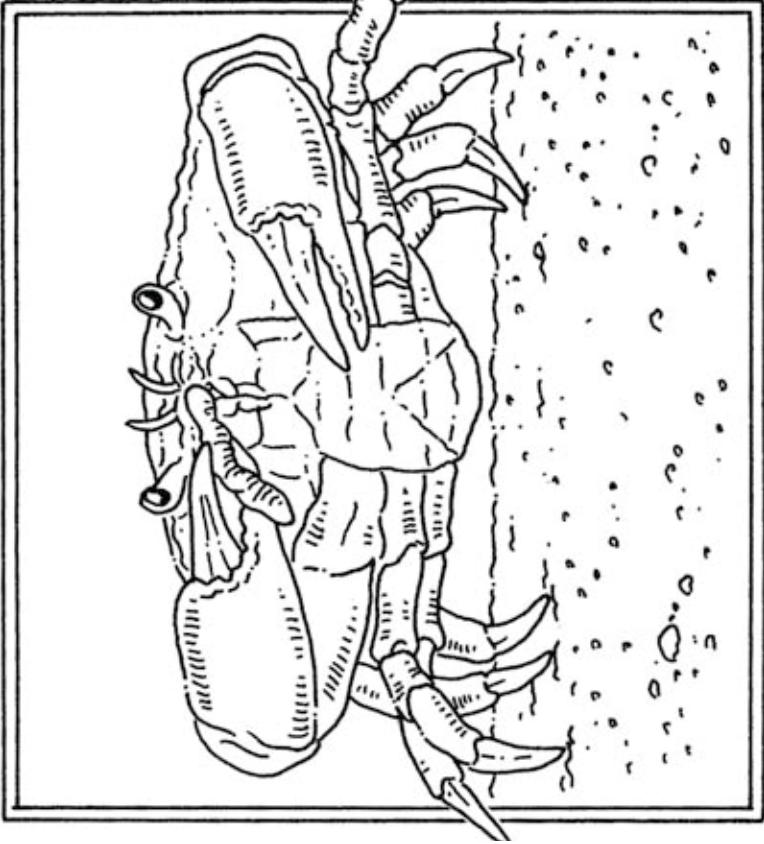

A crab can grab.
It will eat a snack.

Phonics: Circle the words in the story with
cr, gr, or sn.

2

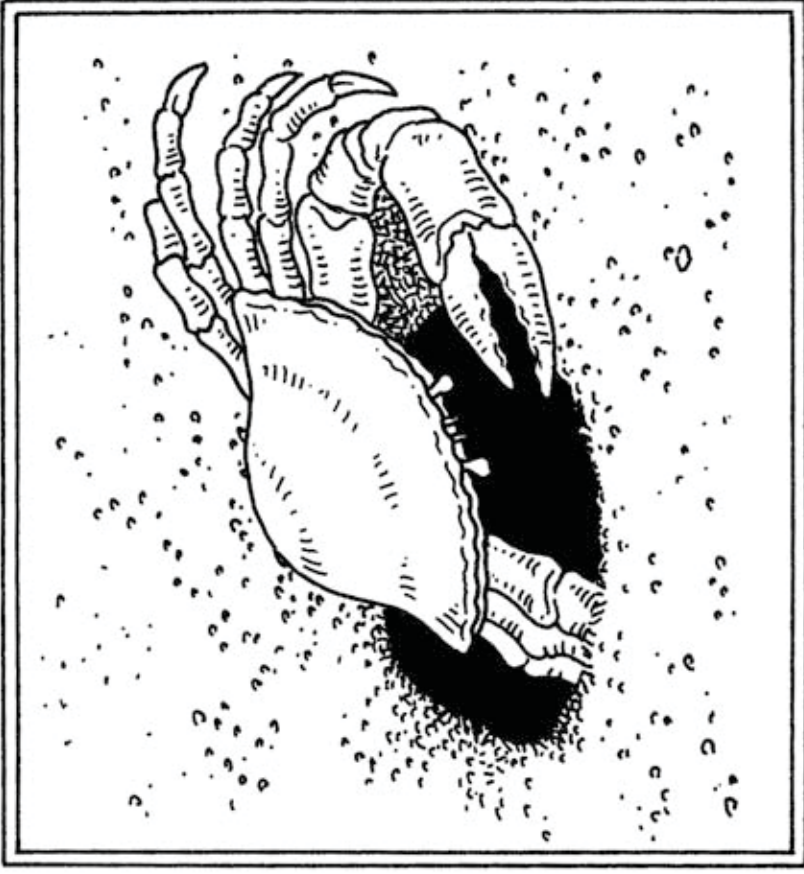













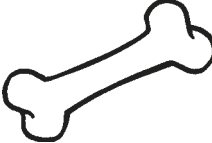
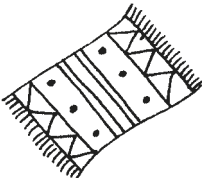

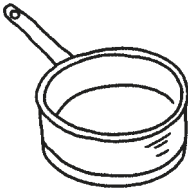
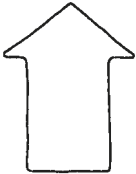
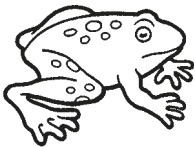
A crab can dig.
It can dig in the sand.

Comprehension: What can crabs do with
their claws?

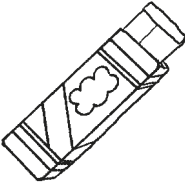
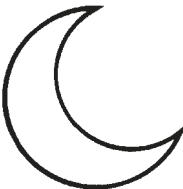
3

Name _____

Say the name of each picture. Circle the picture whose name rhymes with the first picture.

1. 			
2. 			
3. 			
4. 			
5. 			

Name _____

drum

Say each picture name. Write u next to the picture if its name has the short u sound.

1.

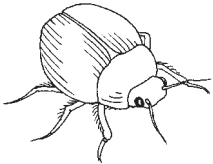

2.



3.

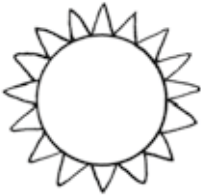

4.



5.



6.



7.



8.



Name _____

A. Read the words in the box. Write one word on each line.

have

to

make

could

1. _____

2. _____

3. _____

4. _____

B. Use a word from the box to finish each sentence.

1. We _____ get a pup.

2. The pup jumps _____ Jim.

3. We can _____ him sit.

4. We _____ fun!

Name _____

Comprehension:
Plot

Stories have a **beginning**, a **middle**, and an **end**.

As you read “Big Bud,” fill in the Plot Chart.

Beginning



Middle



End

Duck in the Mud

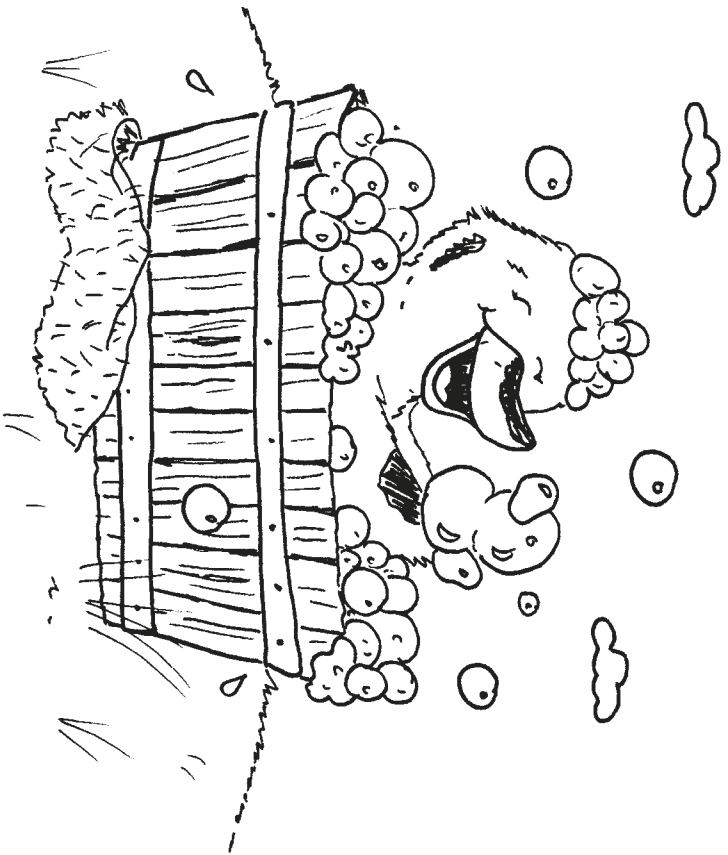

Duck gets in.

Duck has lots of fun!

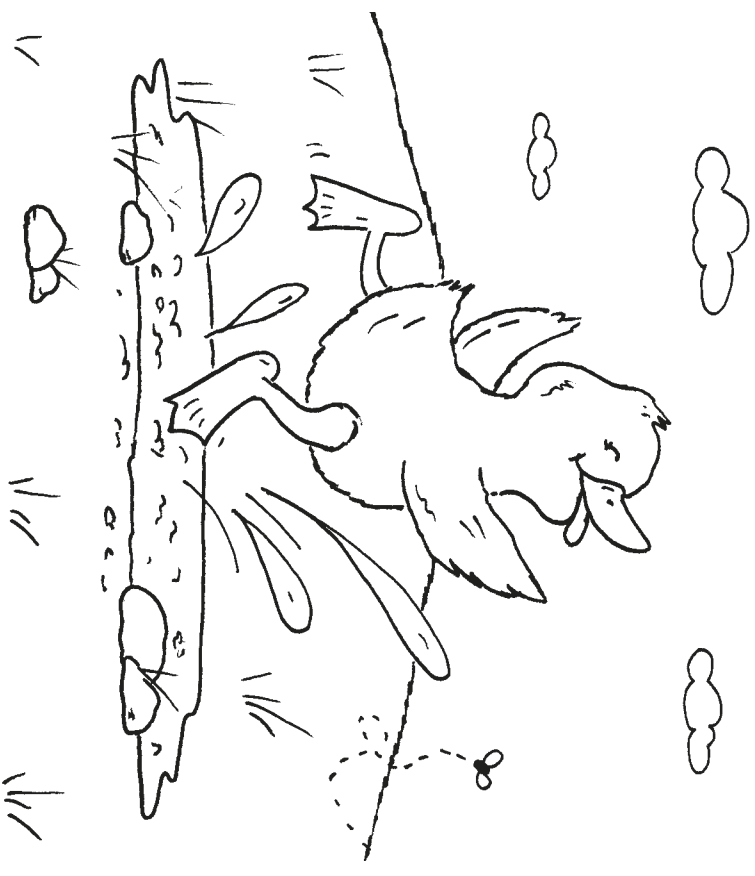

Duck can have fun in the mud.

Duck runs in the mud.

High-Frequency Words:
Circle the words make
and have in the story.



At Home: Ask your
child to read the
book aloud to you.

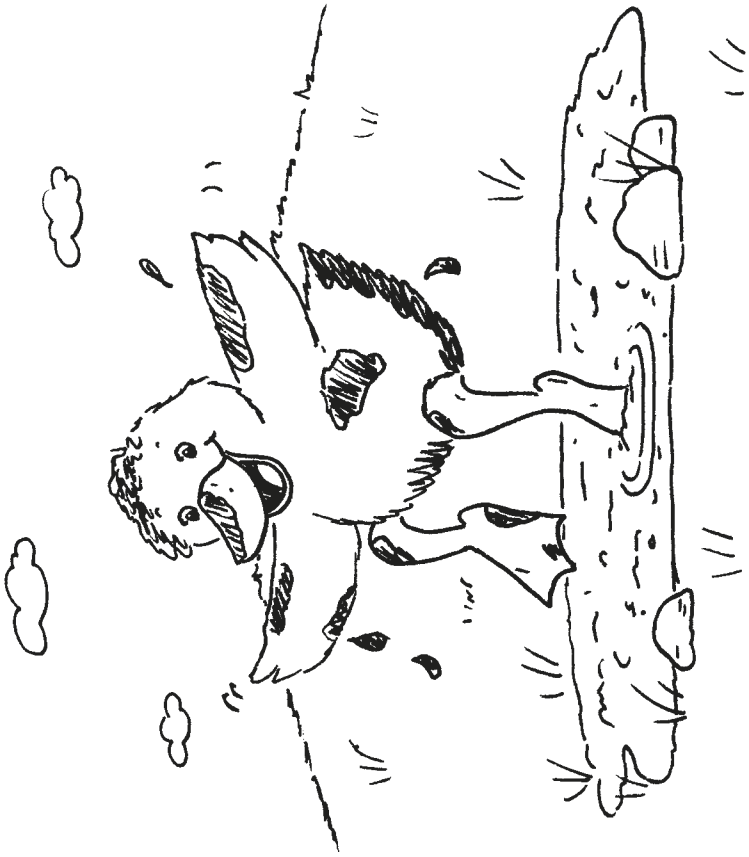

Duck jumps in the mud.
Duck can make a big mess.

Phonics: Circle words in the story that have the **short u** sound.

2

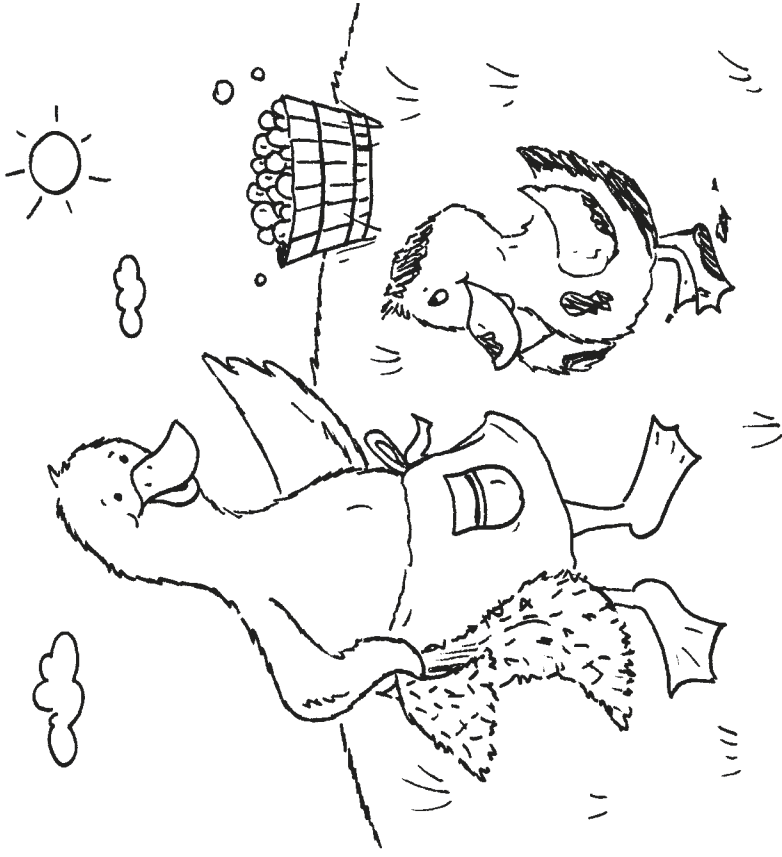





Duck must get a bath.
Will Duck get in?

Comprehension: What is Duck's problem?



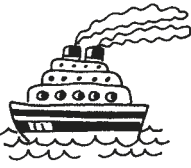
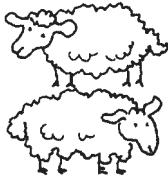
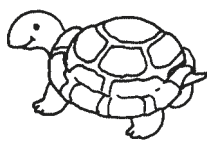

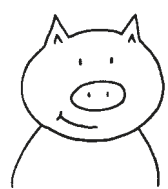
3

Name _____

A. Say the name of each picture. Circle the picture whose name begins with the same sound as the first picture.

1. 			
2. 			

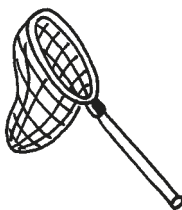
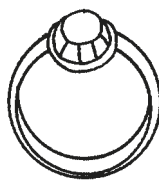
B. Say the name of each picture. Circle the picture whose name ends with the same sound as the first picture.

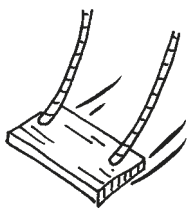
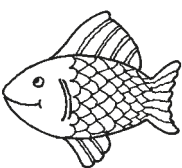
1. 			
2. 			

Name _____



ship



bath

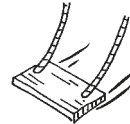

swing

Say each picture name. Write sh next to the picture if its name has the /sh/ sound. Write th next to the picture if its name has the /th/ sound. Write ng next to the picture if its name has the /ng/ sound.

1.

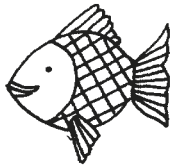

sh

2.



3.



4.

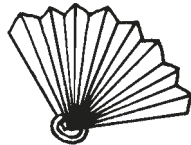

5.



6.



7.

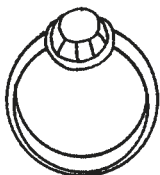

8.

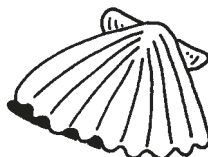

Name _____

A. Read the words in the box. Write one word on each line.

want together you me

- | | |
|--------------------------------|--------------------------------|
| 1. _____
- - - - -
_____ | 2. _____
- - - - -
_____ |
| 3. _____
- - - - -
_____ | 4. _____
- - - - -
_____ |

B. Use a word from the box to finish each sentence.

1. Look at _____ go!

2. I _____ to run and jump.

3. Can we play _____ ?



4. It is fun to play with _____ .

Name _____

Retelling a story helps you remember the most important parts. You can then share the story with others.

As you read “At the Shop,” fill in the Retelling Chart.

At the Shop

Beginning

1.	→	2.
----	---	----

Middle

3.	→	4.
----	---	----

Ending

5.	→	6.
----	---	----



A ship is in with the fish.
Fish swim to it.

Seth's Fish Shop



Seth has a fish shop.
Fish swim in tanks together.

4

High-Frequency Words:
Circle the words want and
together in the story.



At Home: Ask your
child to read the
book aloud to you.



Seth looks at the fish.
What can they want?

Phonics: Circle words in the story with **sh**.

2

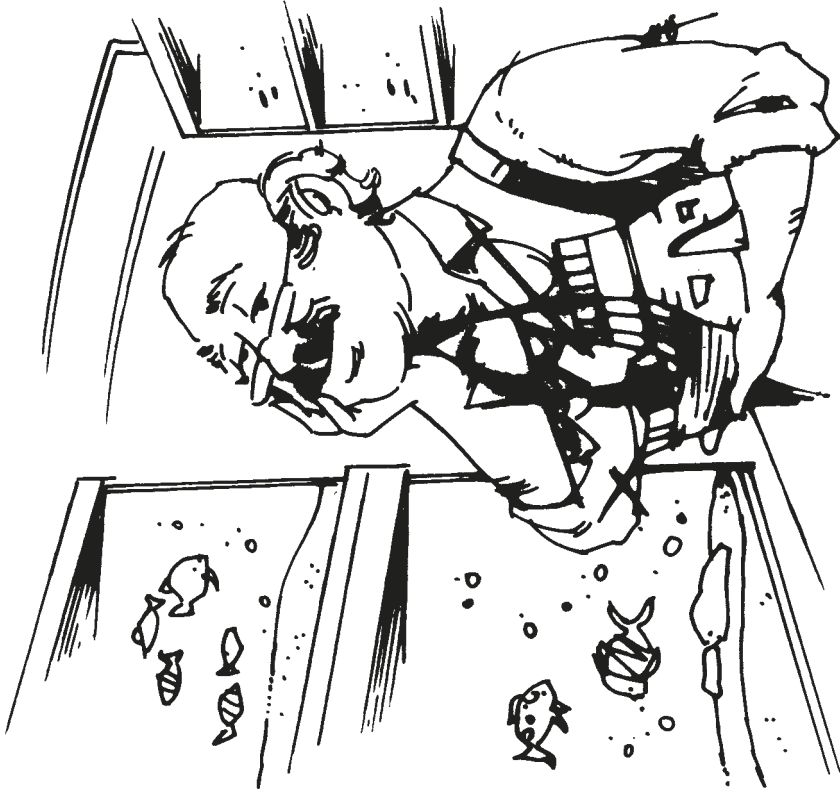











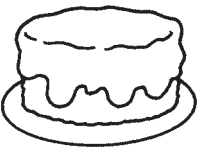
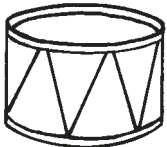

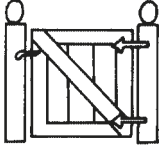
Seth thinks and thinks.
Seth gets a ship.

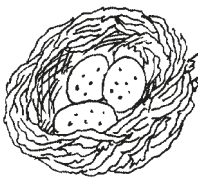
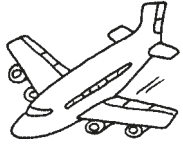
Comprehension: Retell this story in your own words.

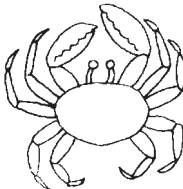
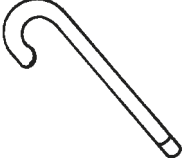
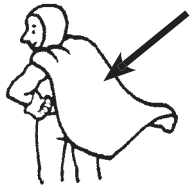
3

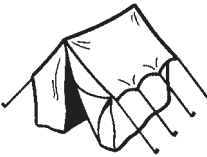
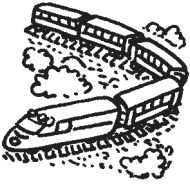
Name _____

Say the name of each picture. Circle the picture whose name rhymes with the first picture.







1. 			
2. 			
3. 			
4. 			
5. 			

Name _____

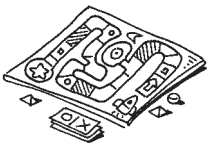

plane

A. Circle the word that names each picture. Then write the word on the line. Underline the letters that make the long a sound.

<p>1.  <u>game</u> name gate</p> <p>_____</p> <p><u>g</u>ame</p>	<p>2.  cap cape cake</p> <p>_____</p> <p>_____</p> <p>_____</p>	<p>3.  bake lake rake</p> <p>_____</p> <p>_____</p> <p>_____</p>
<p>4.  man name mane</p> <p>_____</p> <p>_____</p> <p>_____</p>	<p>5.  cap cake cane</p> <p>_____</p> <p>_____</p> <p>_____</p>	<p>6.  lake last lane</p> <p>_____</p> <p>_____</p> <p>_____</p>

B. Write the word that names the picture.

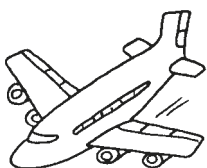

--	--	--	--	--

Name _____

A. Read the words in the box. Write one word on each line.

today

away

said

eat

1. _____

2. _____

3. _____

4. _____

B. Use a word from the box to finish each sentence.

1. What do Dave and Kate want to _____ ?

2. "Look at the cake," _____ Kate.



3. We can play _____ .

4. We take the dogs and go _____ .



Name _____

Retelling a story helps you remember the most important parts. You can then share the story with others.

As you read “Jake’s Cake,” fill in the Retelling Chart.

Jake’s Cake

Beginning

1.	→	2.
----	---	----

Middle

3.	→	4.
----	---	----

Ending

5.	→	6.
----	---	----

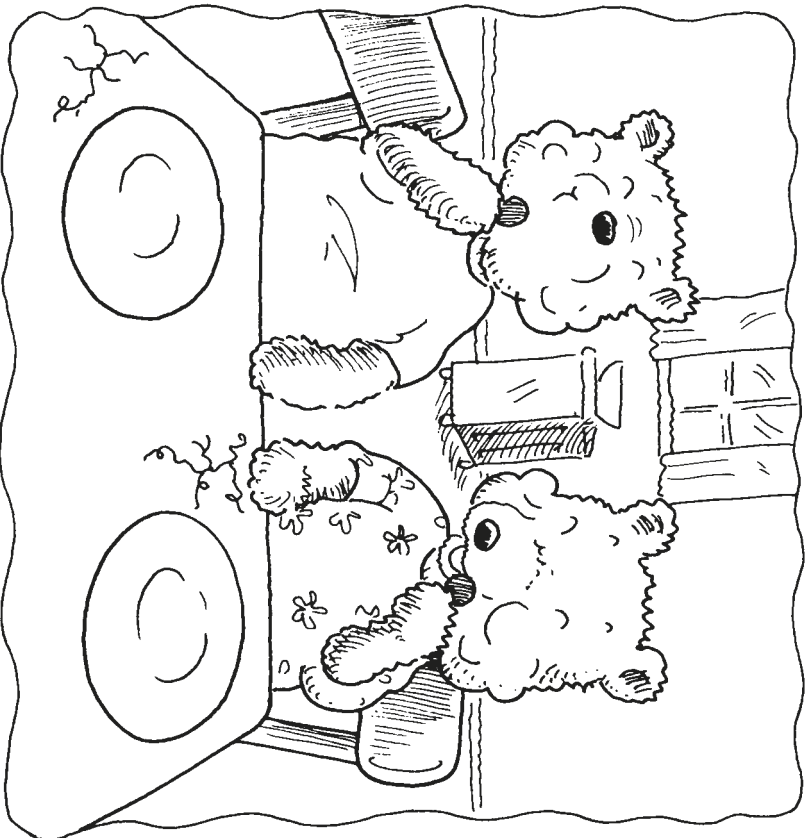

Jake ate grapes.
Jane ate grapes.
Yum! Yum!

Jake and Jane

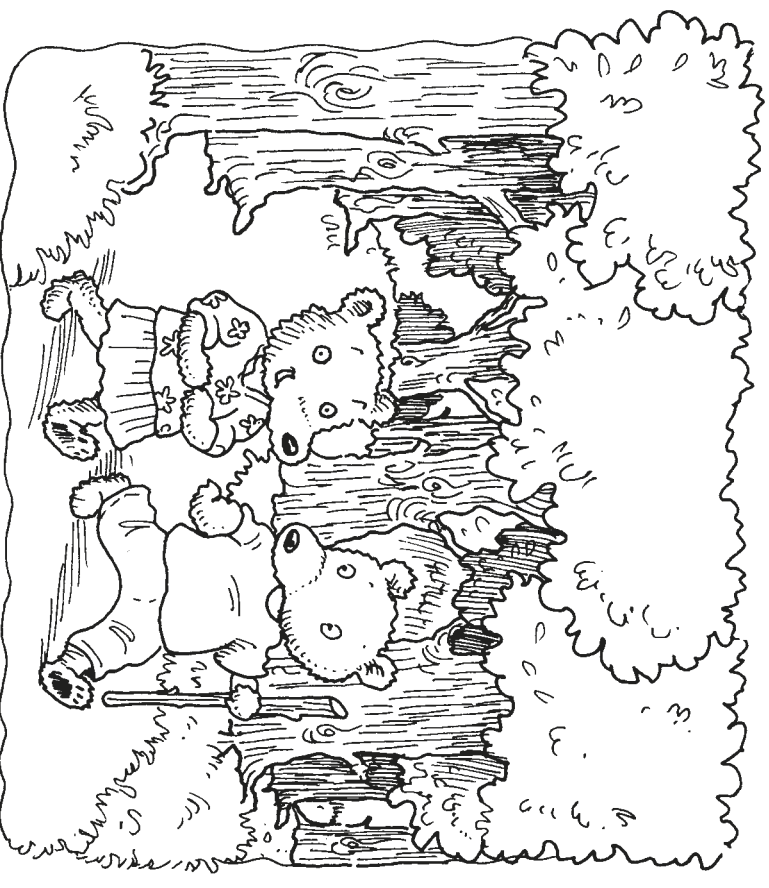

Jake and Jane are pals.
They do things together.
“Let’s eat grapes!” said Jane.
“Yes, yes,” said Jake.



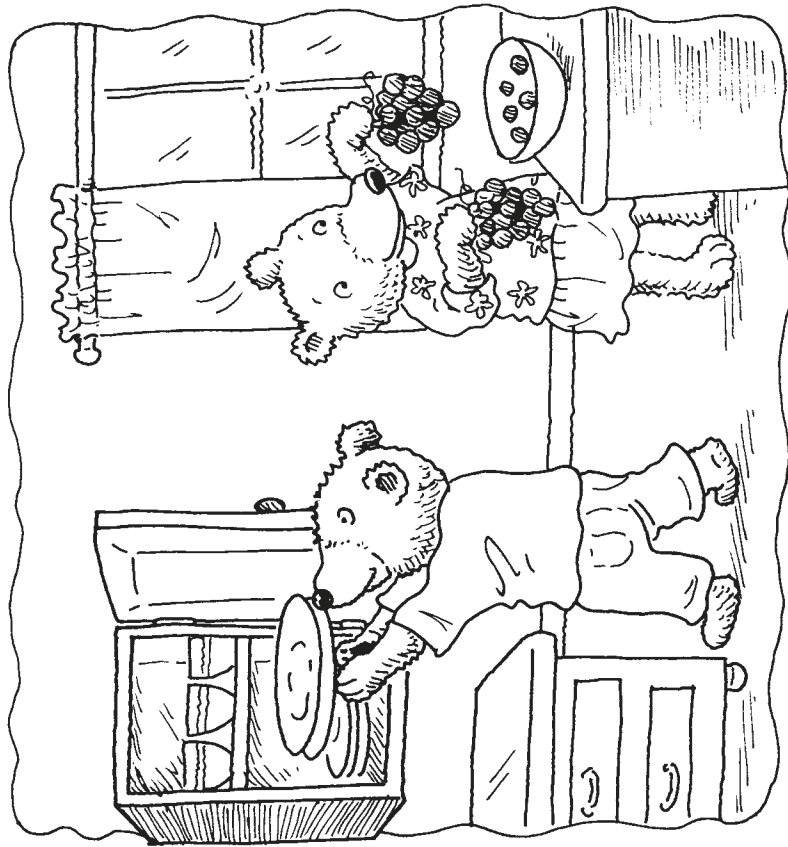

Jake got big plates.
Then Jane got red grapes.

Phonics: Draw a line under the letters that spell the long **a** sound in words.

2

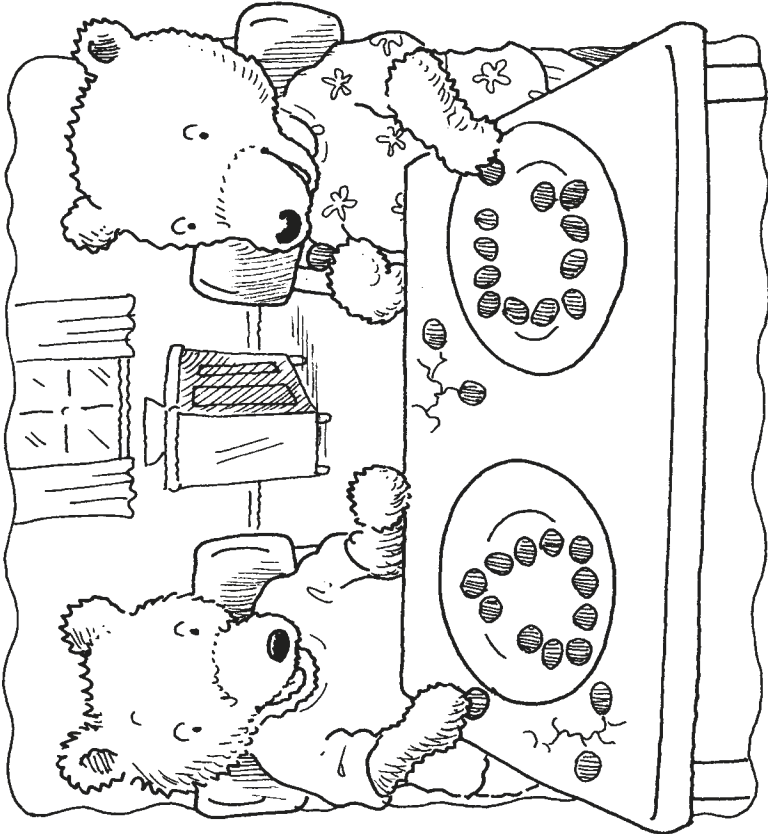













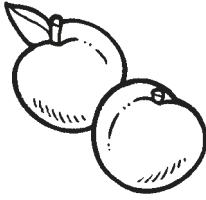

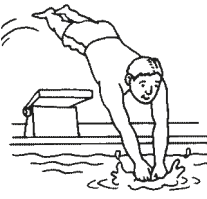
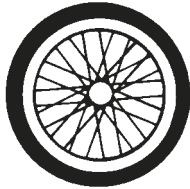
Jake made shapes with
his grapes.
Jane made shapes with
her grapes.

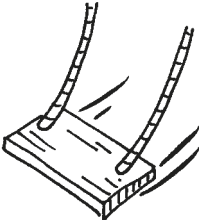
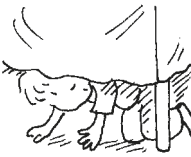
Comprehension: What do Jake and Jane do with their grapes?

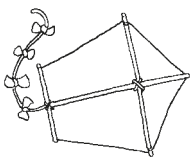
3

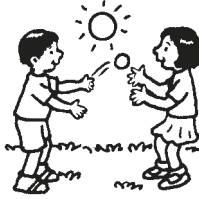
Name _____

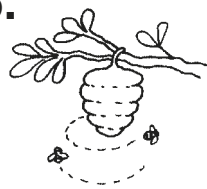
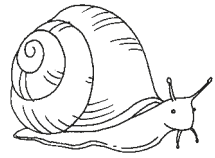
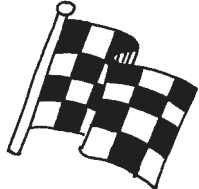
Say the name of each picture. Circle the picture whose name rhymes with the first picture.

<p>1.</p> 			
<p>2.</p> 			
<p>3.</p> 			
<p>4.</p> 			
<p>5.</p> 			

Name _____

5
five

Finish each word ladder. Change only one letter at a time.

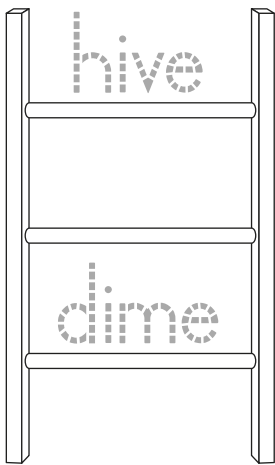
1. Go from **hive** to **dime**.

Hint:

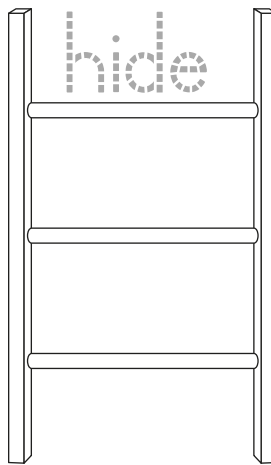
Change
h to d2. Go from **hide** to **time**.

Hint:

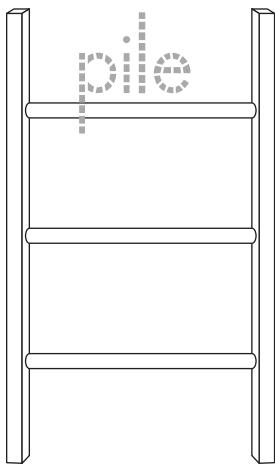
Change
h to t3. Go from **pile** to **ripe**.

Hint:

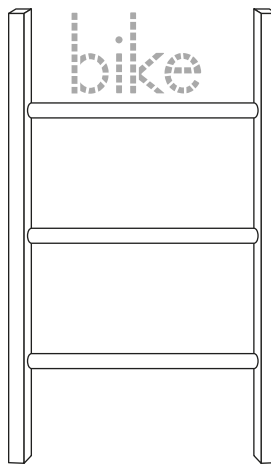
Change
l to p4. Go from **bike** to **kite**.

Hint:

Change
k to t

Name _____

A. Read the words in the box. Write one word on each line.

where

now

how

there

1. _____

2. _____

3. _____

4. _____

B. Use a word from the box to finish each sentence.

1. _____ go the ducks!

2. _____ will the ducks get to the lake?

3. _____ I want to see the frogs.

4. _____ did the frogs go?

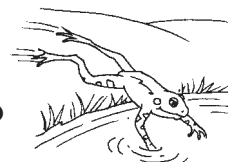
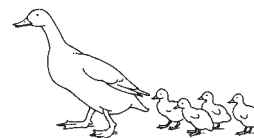

Name _____

To **predict** means to make a good guess about what you think will happen next in a story.

As you read “Miss Fine’s Dime,” fill in the Predictions Chart.

What I Predict	What Happens

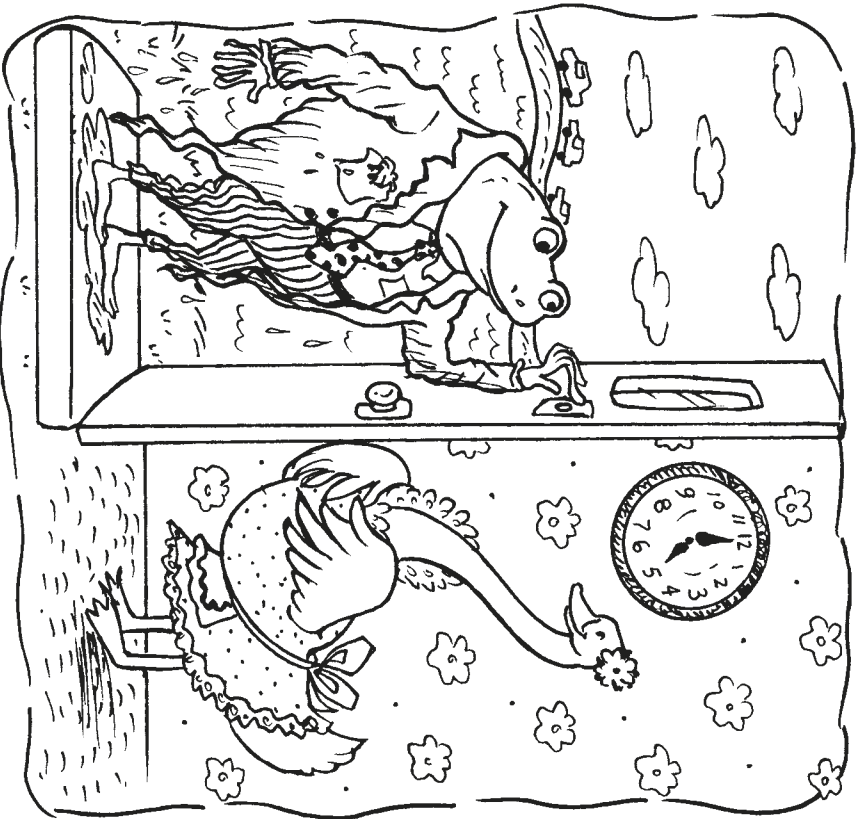

It is five!

Mike is just in time.



At Home: Ask your child to read the book aloud to you.

High-Frequency Words:
Circle the words there
and how in the story.

4

Just in Time



Mike will eat with Miss Fine.

Mike must be there at five.

© Macmillan/McGraw-Hill

© Macmillan/McGraw-Hill

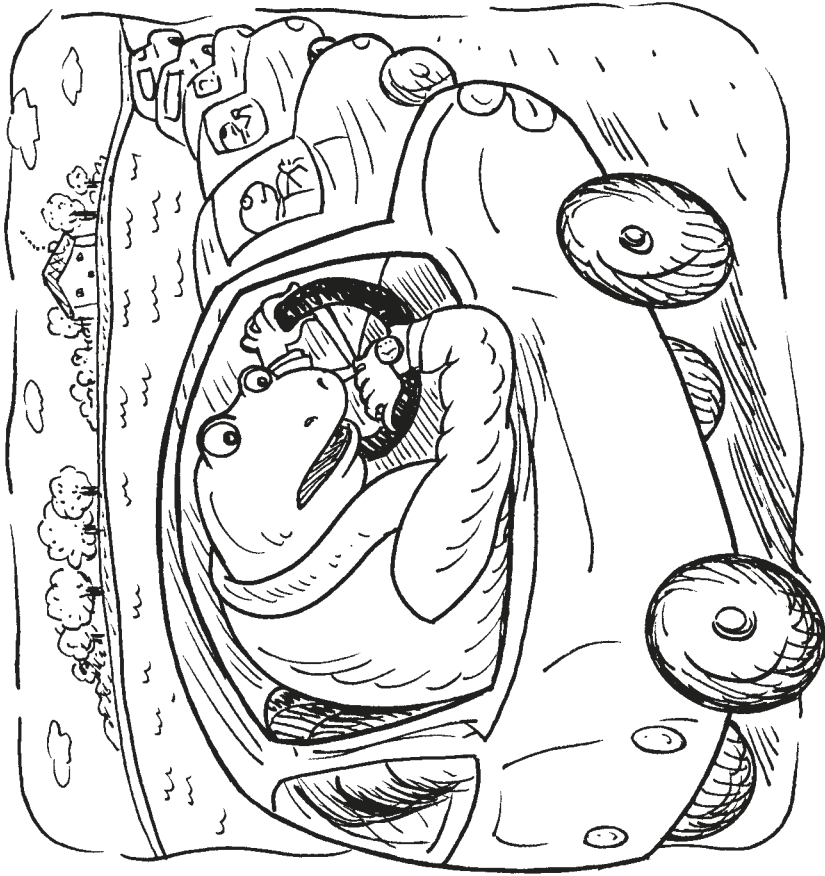

Mike is in a big line.
How will Mike get there
at five?

Phonics: Circle the long i words in the story.

2

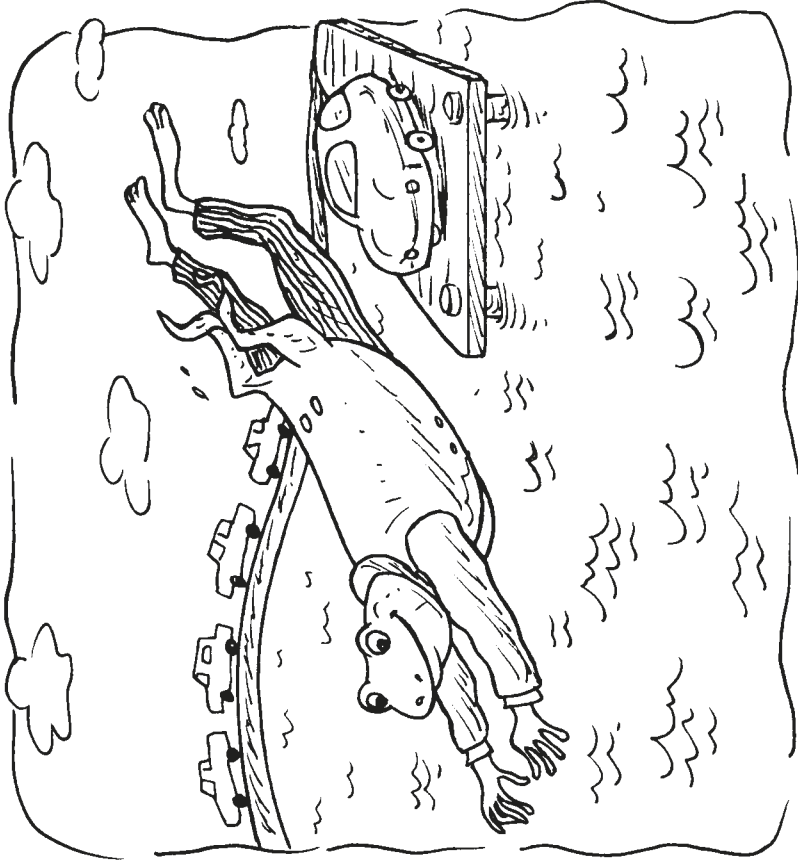



Mike likes to dive.
Mike dives in the lake.

Comprehension: Will Mike get to Miss Fine's home on time?



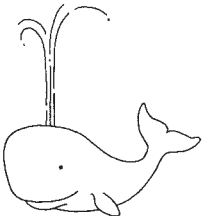
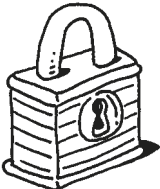
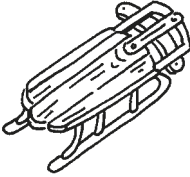
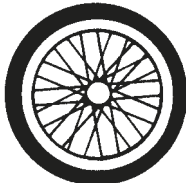

3

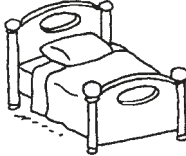
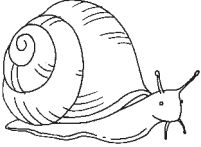
Name _____

A. Say the name of each picture. Circle the picture whose name begins with the same sound as the first picture.

1. 			
2. 			

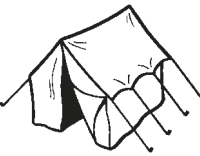
B. Say the name of each picture. Circle the picture whose name ends with the same sound as the first picture.

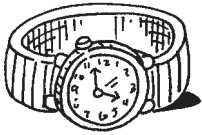
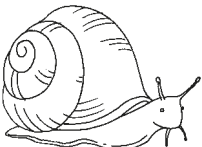
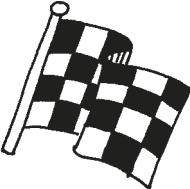
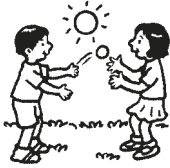
1. 			
2. 			

Name _____



chop







cach

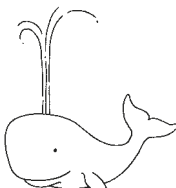

whip

A. Circle the word that names each picture. Then write the word on the line.

<p>1.  check chick clap</p> <p><u>chick</u></p>	<p>2.  swing when whale</p> <p>_____</p> <p>_____</p> <p>_____</p>	<p>3.  chin chop fish</p> <p>_____</p> <p>_____</p> <p>_____</p>
<p>4.  itch chip which</p> <p>_____</p> <p>_____</p> <p>_____</p>	<p>5.  slap chug check</p> <p>_____</p> <p>_____</p> <p>_____</p>	<p>6.  whip switch slide</p> <p>_____</p> <p>_____</p> <p>_____</p>

B. Circle the ch, -tch, or wh- spelling pattern in each answer above.

Name _____

A. Read the words in the box. Write one word on each line.

our

your

under

was

1. _____

2. _____

3. _____

4. _____

B. Pick two words from the box and use each word in a sentence. Write the sentences on the lines.

1. _____

2. _____

Name _____

The **main idea** is the most important idea in a story.
Details in the story tell more about the main idea.

As you read “Snakes, Snakes, Snakes!,” fill in the Main Idea and Details Chart.

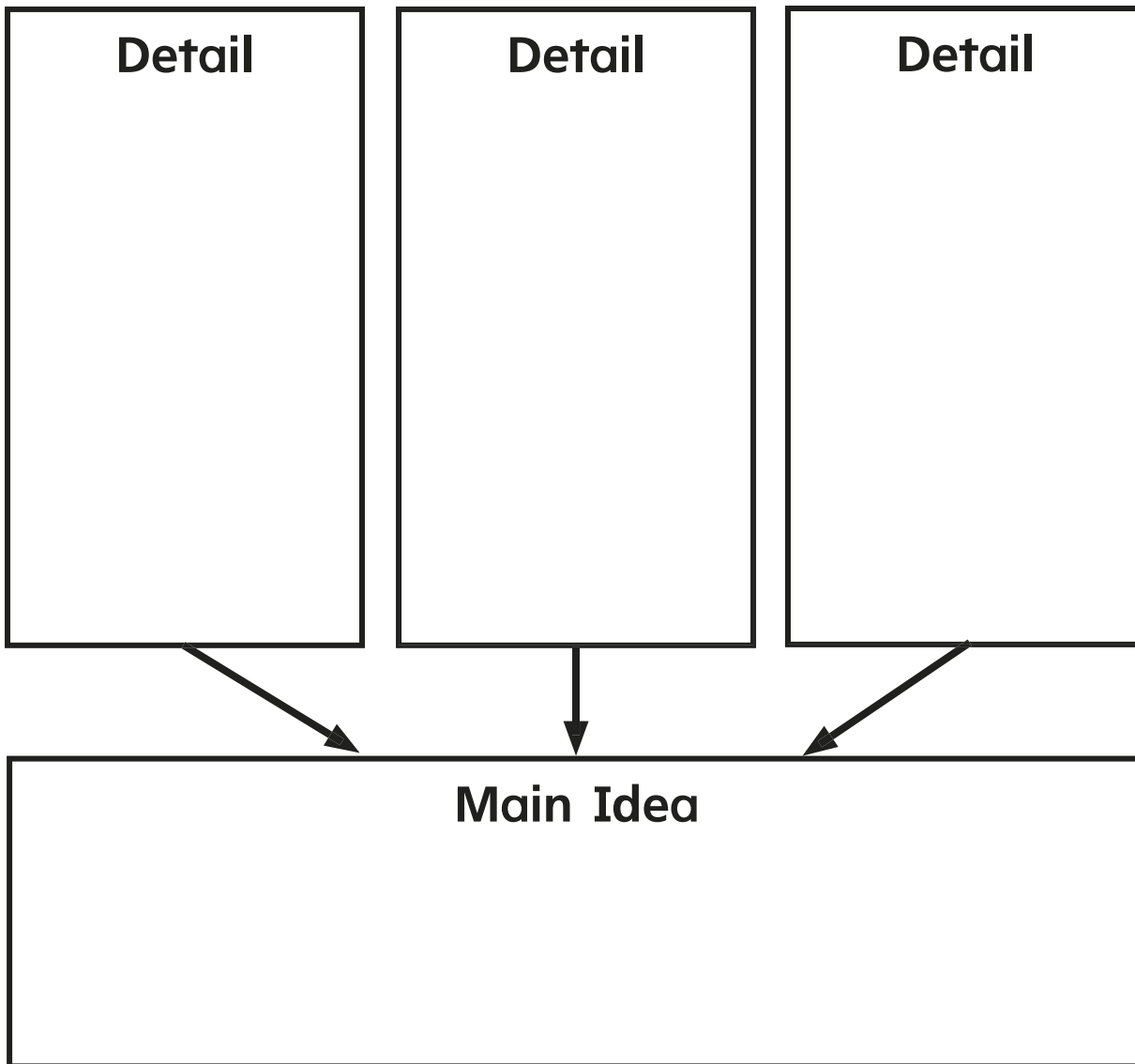



This cloth has checks.
Your lunch is on top.
Checks are under it.
It is fun to eat on checks!

High-Frequency Words:
Circle the words under
and your in the story.



At Home: Ask your
child to read the
book aloud to you.

4

© Macmillan/McGraw-Hill

Checks, Checks, Checks!

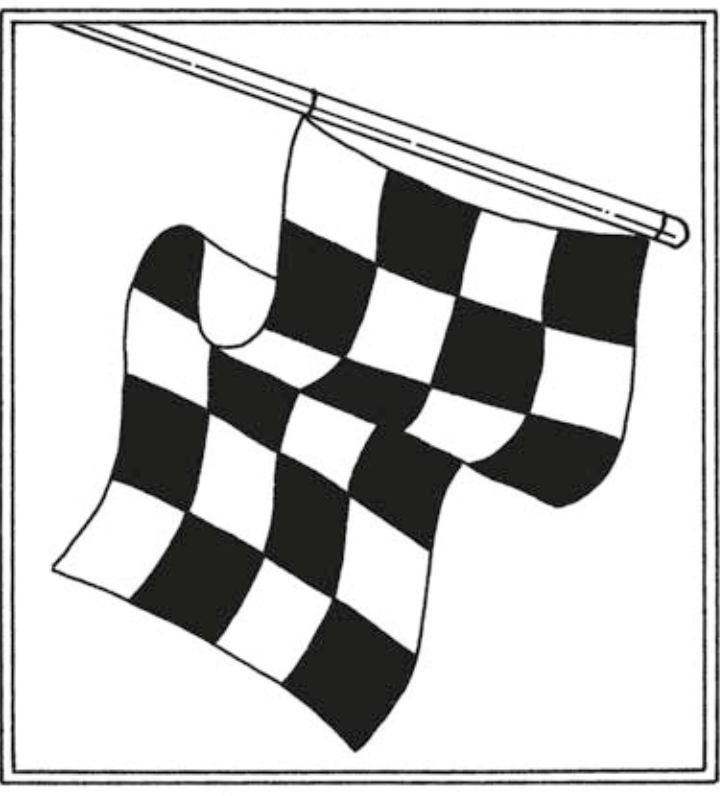

Checks look like this.
Lots of things have checks.

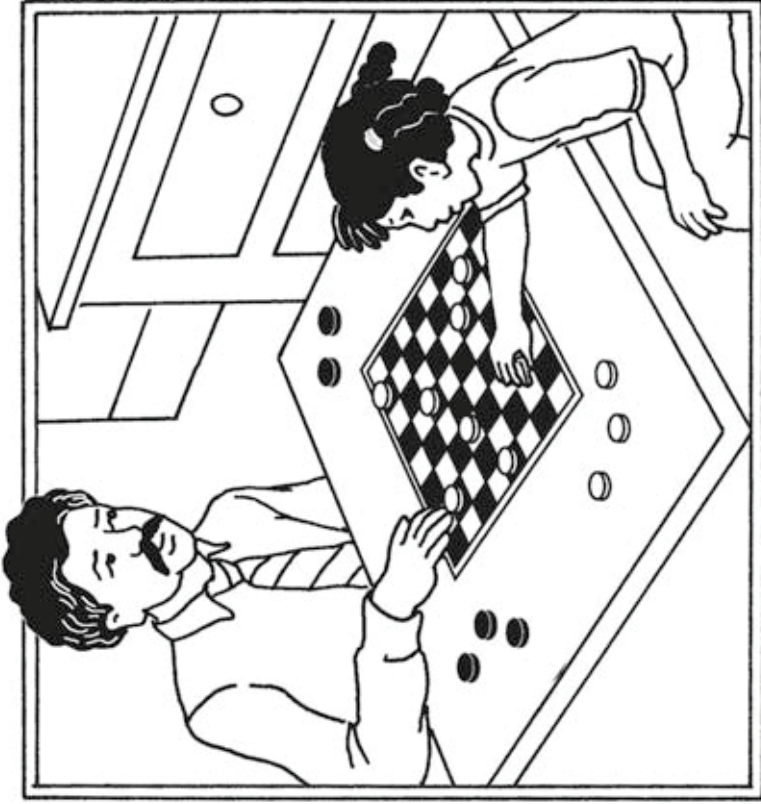

This game has checks.
It has black and white checks.
It is fun to play on checks.

Phonics: Draw a circle around the words in the story with **ch** and **tch**.

2

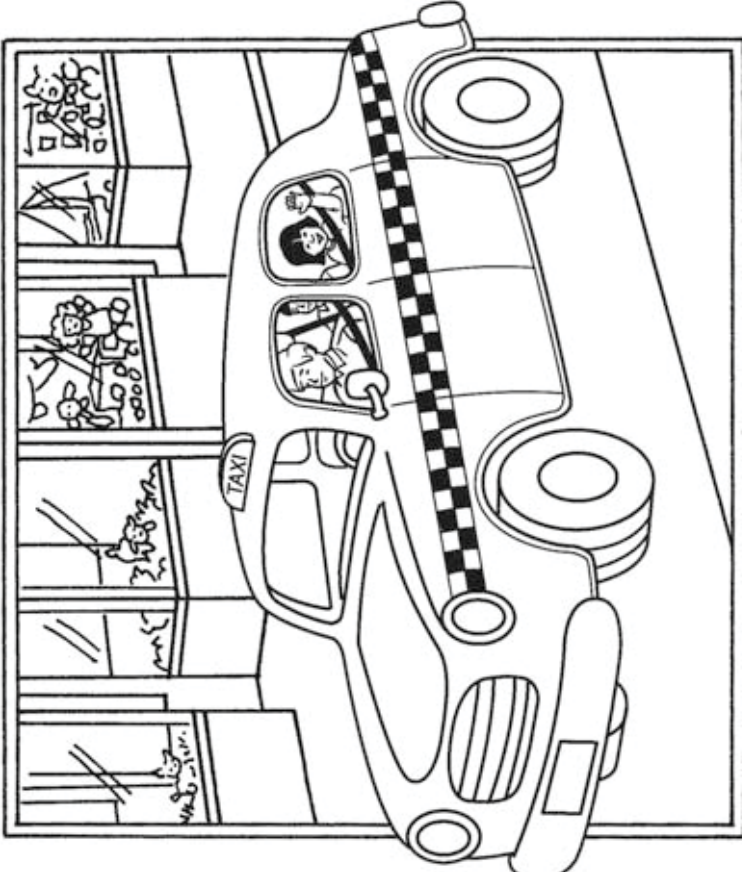











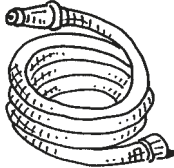
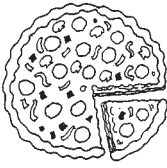

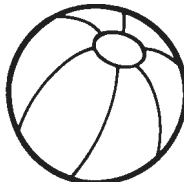
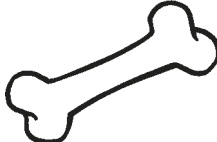
Cabs have checks.
When you see the checks,
you can tell it is a cab.
It is fun to ride in checks.

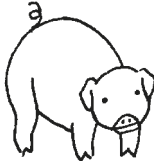
Comprehension: Retell this story in your own words.

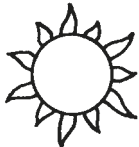
3

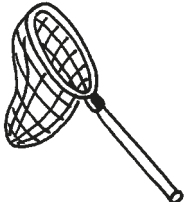
Name _____

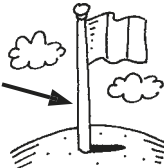
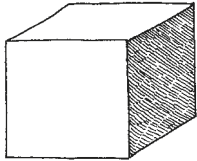
Say the name of each picture. Circle the picture whose name rhymes with the first picture.

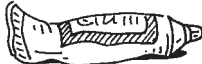
1. 			
2. 			
3. 			
4. 			
5. 			

Name _____



mule



bone

Say each picture name. Write u next to the picture if its name has the long u sound. Write o next to the picture if its name has the long o sound.

1.

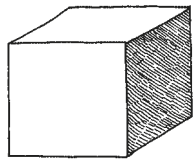

u

2.



3.

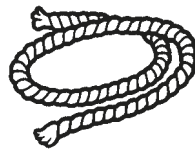

4.



5.

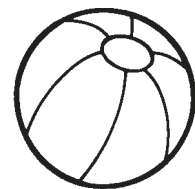

6.

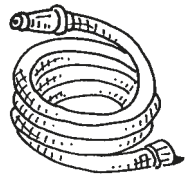

7.

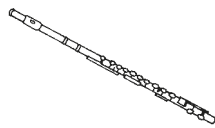

8.



Name _____

A. Read the words in the box. Write one word on each line.

new

she

work

he

1. _____

2. _____

3. _____

4. _____

B. Use a word from the box to finish each sentence.

1. Tom has a _____ mule.

2. _____ dug a hole.

3. _____ likes to bake.

4. Dad will take lunch to _____.

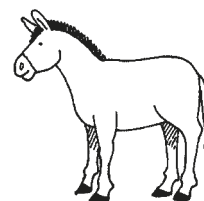

Name _____

When we read, sometimes we have to “fill in the blanks.”
This is called **drawing conclusions**.

As you read “June’s Flute,” fill in the Conclusion Chart.

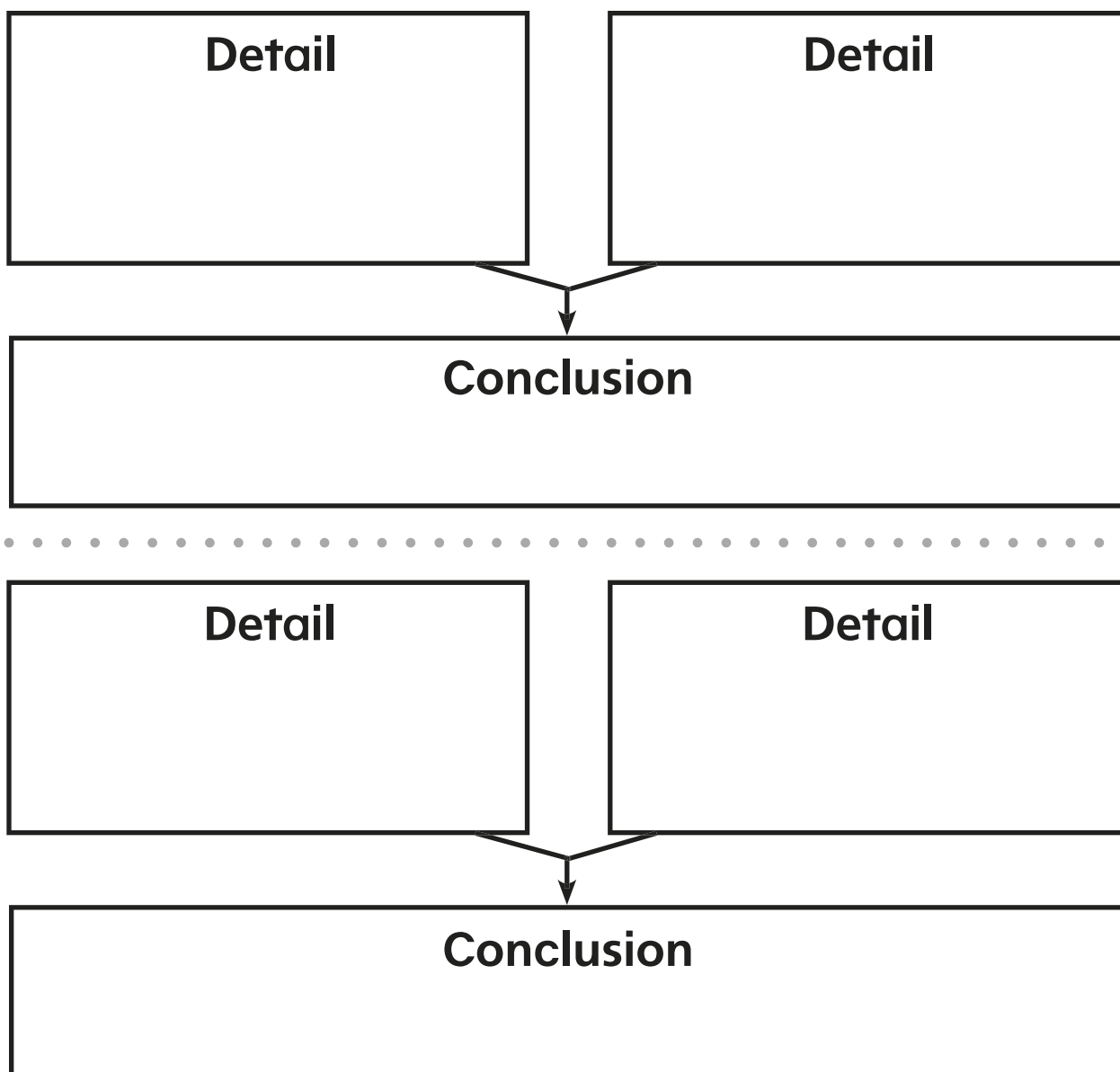

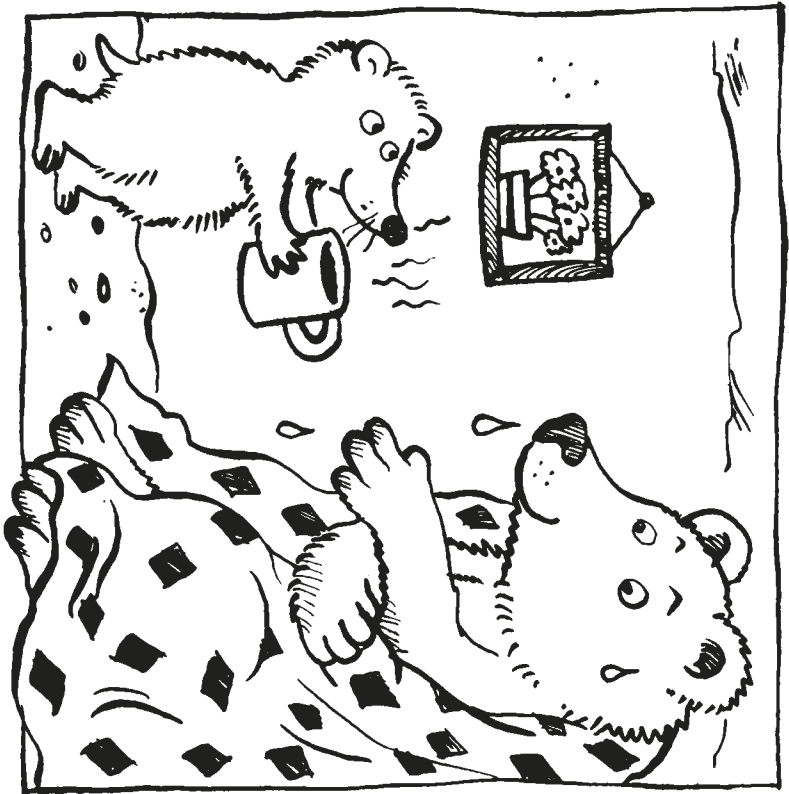

Cub did fit in.

“You are huge but cute,”
said Mole.

Cub and Mole had fun.

High-Frequency Words:
Circle the word he in the
story.



At Home: Ask your
child to read the
book aloud to you.

Cub and Mole

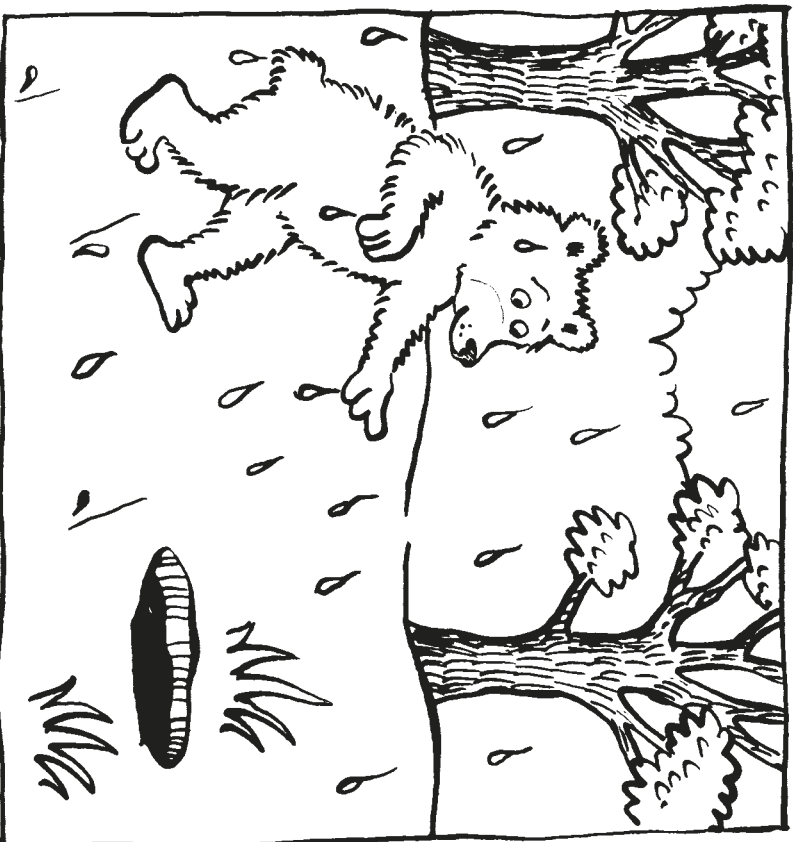

Cub was wet, wet, wet.
He went to Mole's home.

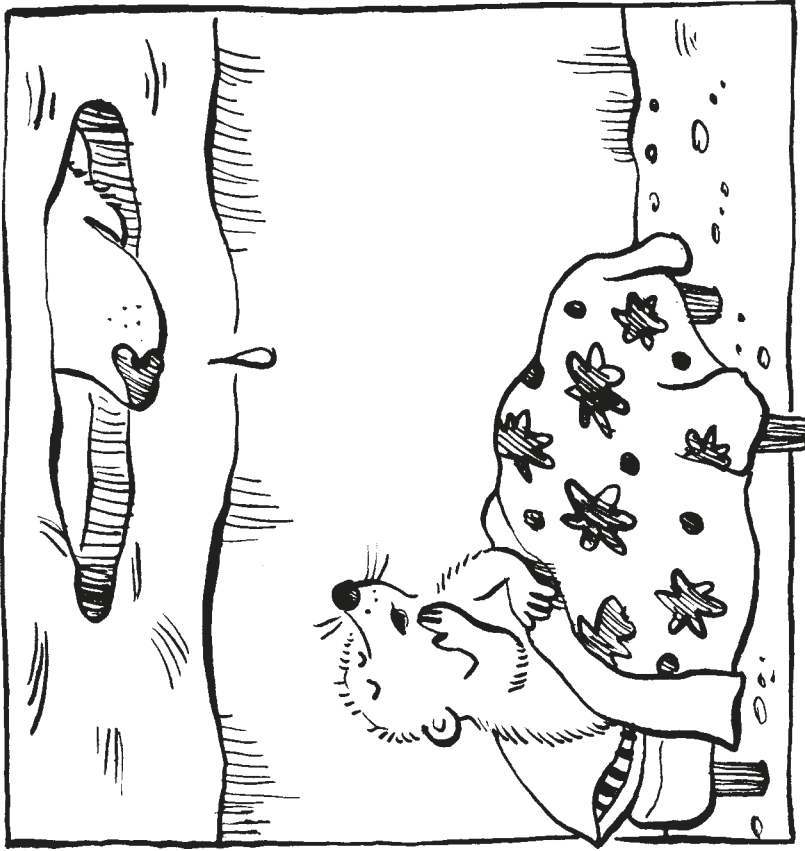

Cub poked his nose in.
Mole woke up.

Phonics: Draw a line under the long o and long u words in the story.

2











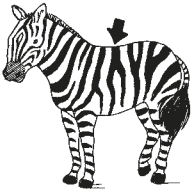

“Mole, can I come in?”
Cub asked.
“If you can fit,” said Mole.

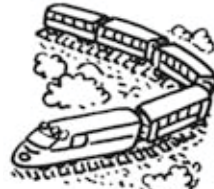
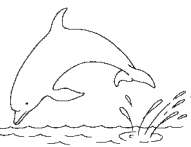
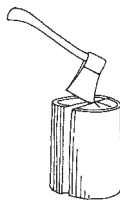
Comprehension: How did Cub get so wet?

3

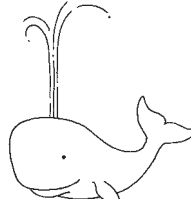
Name _____

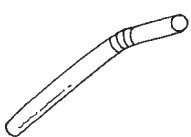
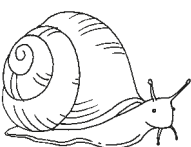
Say the name of each picture. Circle the picture whose name begins with the same sounds as the first picture.

1. 			
2. 			
3. 			
4. 			5

Name _____





spr

str

scr

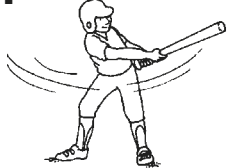
spl

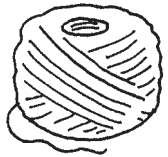
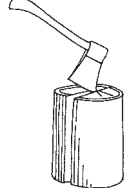
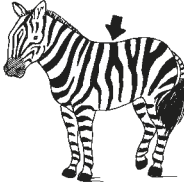
Write the missing letters to finish the picture name.

<p>1.</p>  <p>spl _____ ash</p>	<p>2.</p>  <p>_____ ick</p>
<p>3.</p>  <p>_____ atch</p>	<p>4.</p>  <p>_____ ub</p>
<p>5.</p>  <p>_____ ing</p>	<p>6.</p>  <p>_____ it</p>
<p>7.</p>  <p>_____ ipe</p>	<p>8.</p>  <p>_____ ing</p>

Name _____

**Circle the word that completes each sentence.
Then write the word on the line.**

1. Lots _____ cats have stripes.
of our

2. May I have a glass of _____ ?
water said

3. Ann _____ on her socks.
now put

4. I am _____ with this.
where done

Name _____

When we look at how two or more things are the same, we **compare** them.

When we look at how they are different, we **contrast** them.

As you read “Let’s Help!,” fill in the Compare and Contrast Chart.

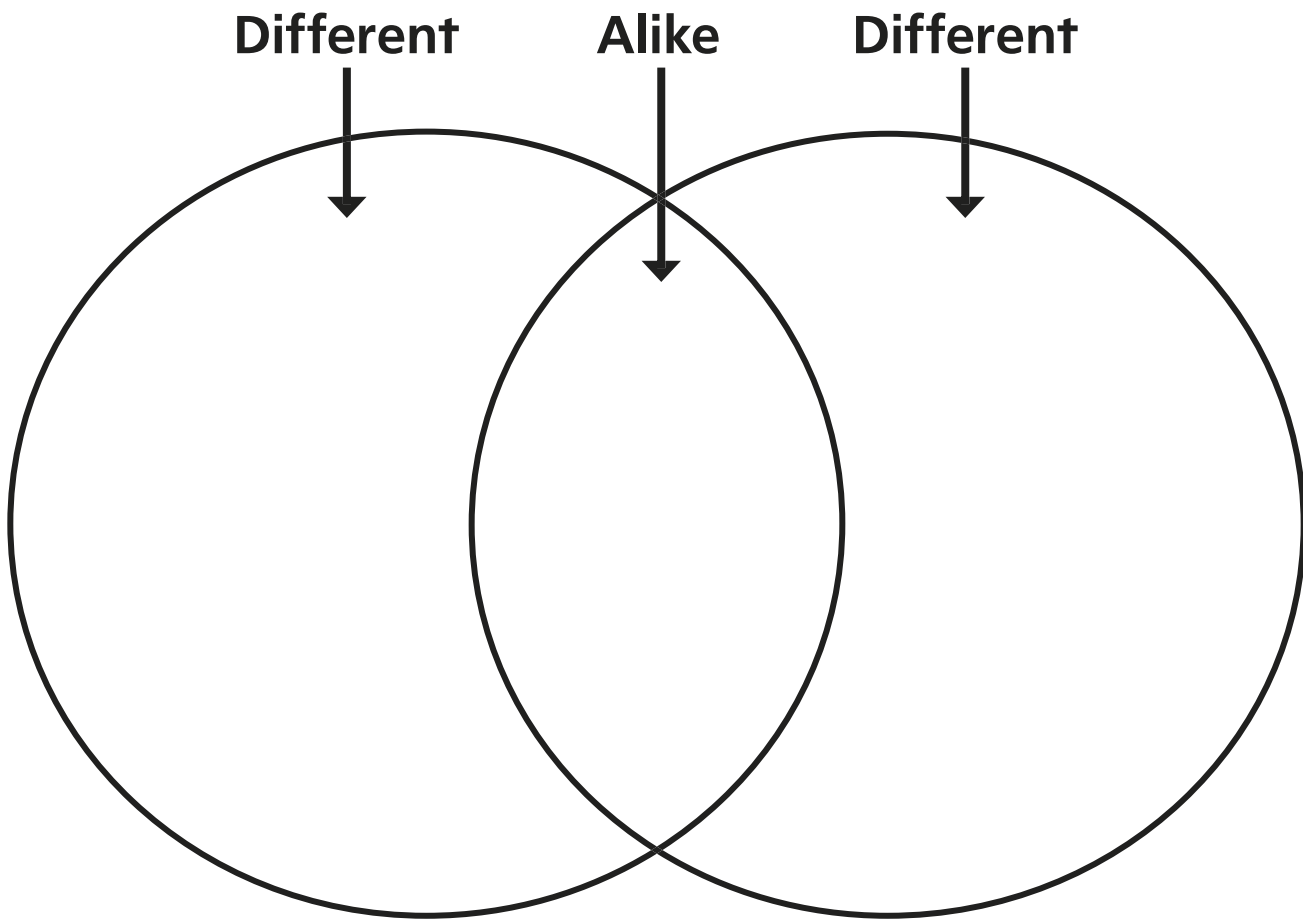



I put Scruff in the tub.

High-Frequency Words:
Circle the word put in
the story.



At Home: Ask your
child to read the
book aloud to you.

It Is Spring!

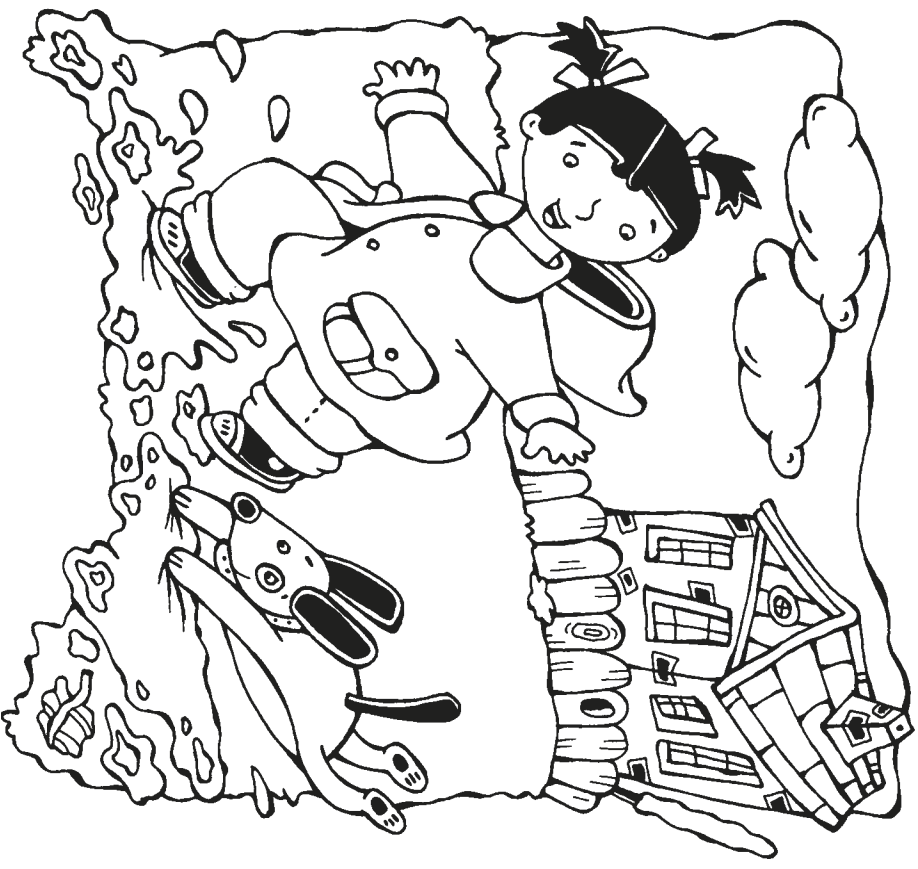

It is spring!
We jump and splash.

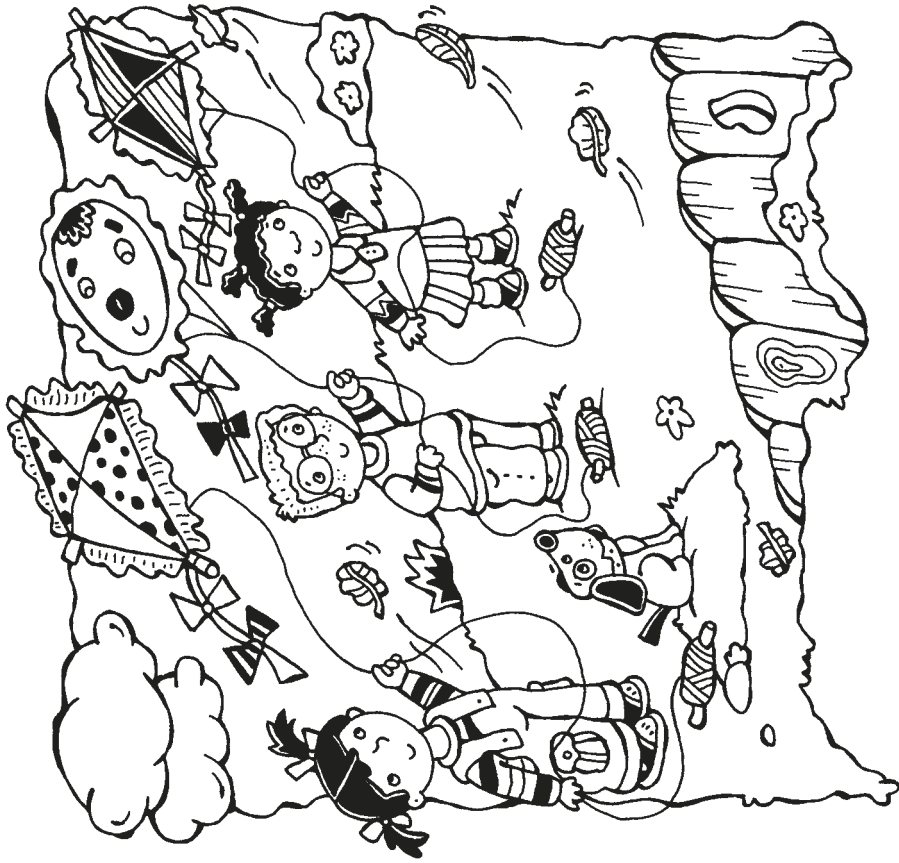

It is spring!
Kites on long strings go
up, up, up.

Phonics: Draw a line under words in the story with **spr**, **str**, or **spl**.

2













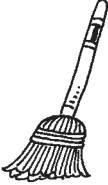

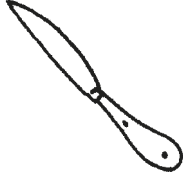

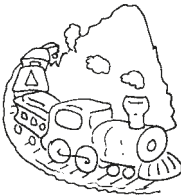

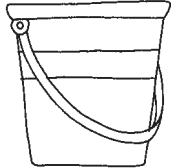
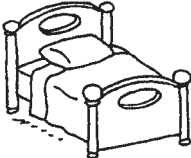
It is spring!
Flags with stripes wave.

Comprehension: How are the flags the same? How are they different?

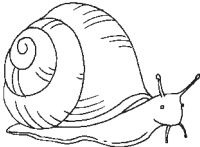
3

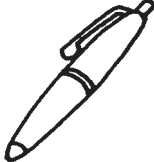
Name _____

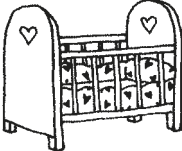
Say the name of each picture. Circle the picture whose name has the same long a sound as the first picture.

1. 			
2. 			
3. 			
4. 			
5. 			

Name _____







rain

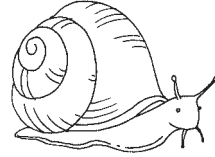
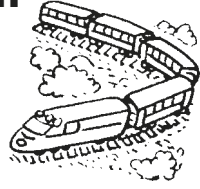

play

Circle the word that names each picture. Then write the word on the line. Underline the letters that make the long a sound.

<p>1.  <u>rain</u> ran wait</p> <p>_____</p> <p><u>rain</u></p>	<p>2.  way clam clay</p> <p>_____</p> <p>_____</p> <p>_____</p>	<p>3.  sail snail snake</p> <p>_____</p> <p>_____</p> <p>_____</p>
<p>4.  trap train day</p> <p>_____</p> <p>_____</p> <p>_____</p>	<p>5.  snail top sail</p> <p>_____</p> <p>_____</p> <p>_____</p>	<p>6.  braid bring brain</p> <p>_____</p> <p>_____</p> <p>_____</p>

Name _____

A. Read the words in the box. Write one word on each line.

walk

into

some

soon

1. _____

2. _____

3. _____

4. _____

B. Use a word from the box to finish each sentence.

1. I see _____ roses.



2. She put the dishes _____ a box.

3. We will be home _____ .

4. The dogs _____ with us.



Name _____

Readers **make predictions**, or guesses, about what might happen in a story. Good readers check their predictions as they read to see if they are correct.

As you read “It Is Raining,” fill in the Predictions Chart.

What I Predict	What Happens

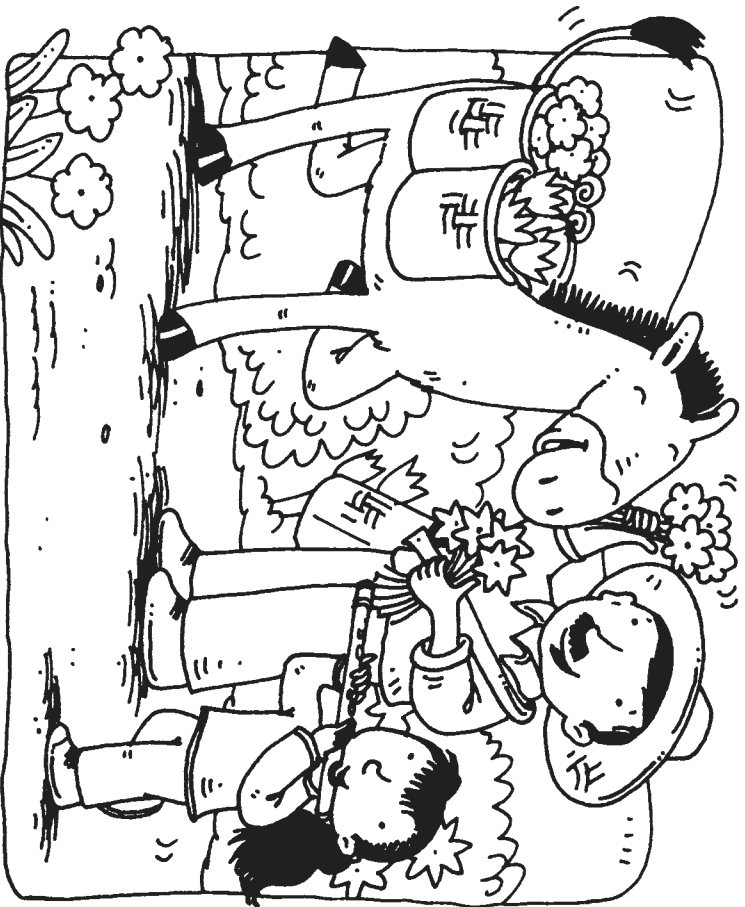

Soon Gray is well.
He kicks and jumps.
Gray likes it when Kay plays.

High-Frequency Words:
Circle the words walk and



At Home: Ask your
child to read the
book aloud to you.

4

soon in the story.

Kay's Mule

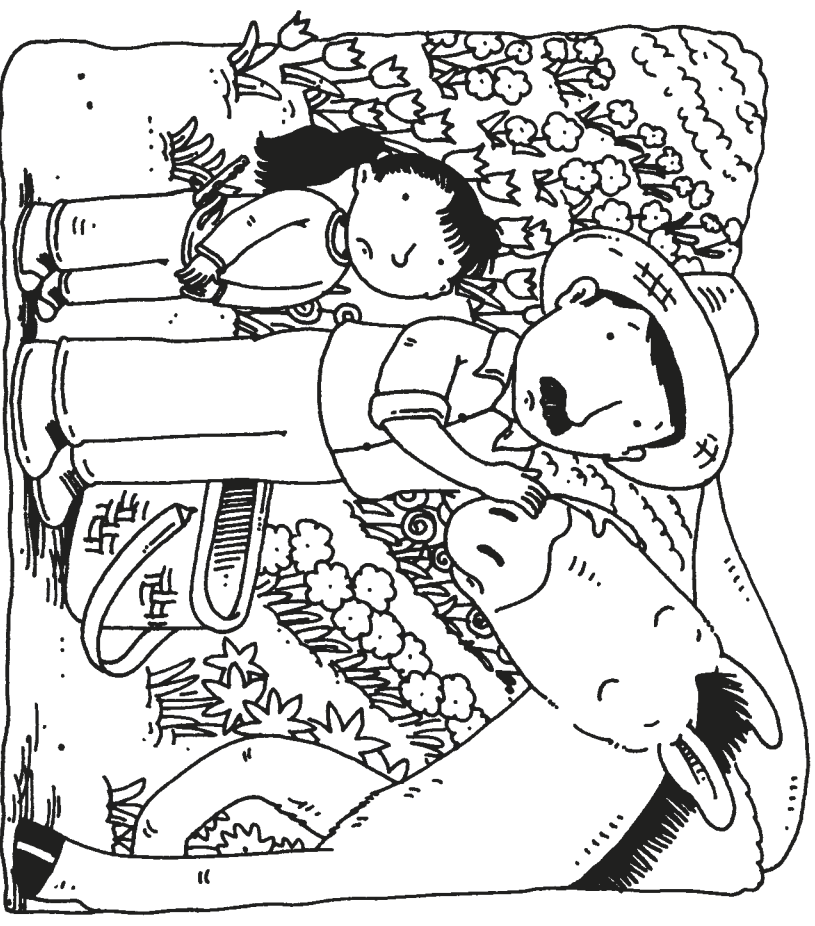

Kay has a gray mule.
The mule's name is Gray.
Today Gray will not walk.
"I think Gray is in pain,"
said Kay.

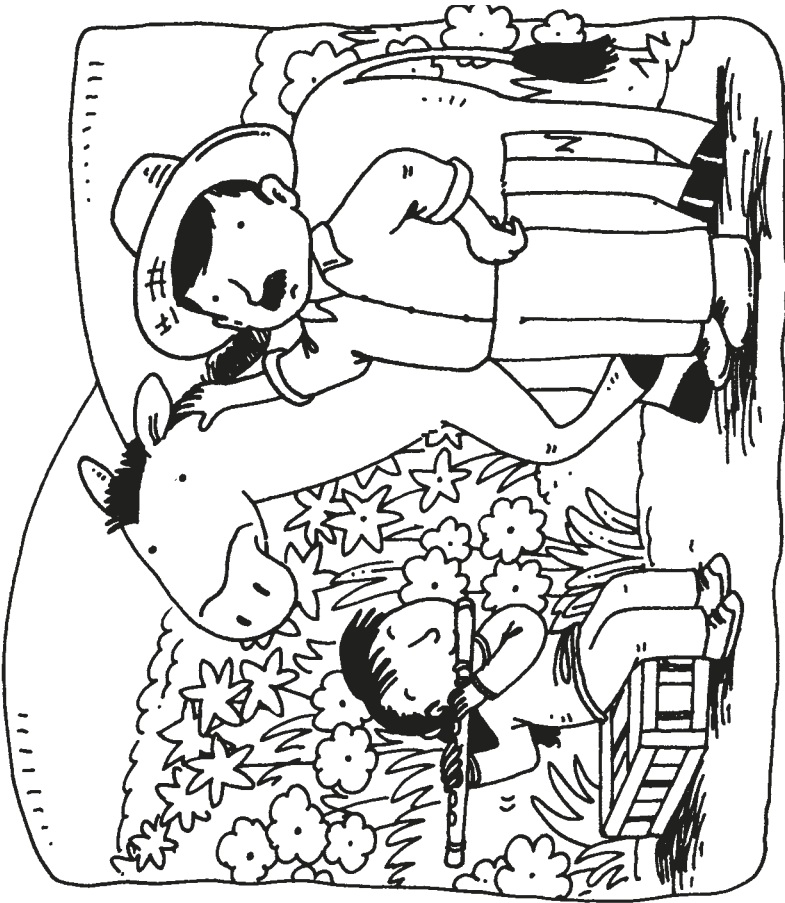

Kay and Dad wait.
They let Gray rest.
“I can play for him,”
said Kay.

Phonics: Draw a line under the long a
spelled **ay** or **ai** words.

2

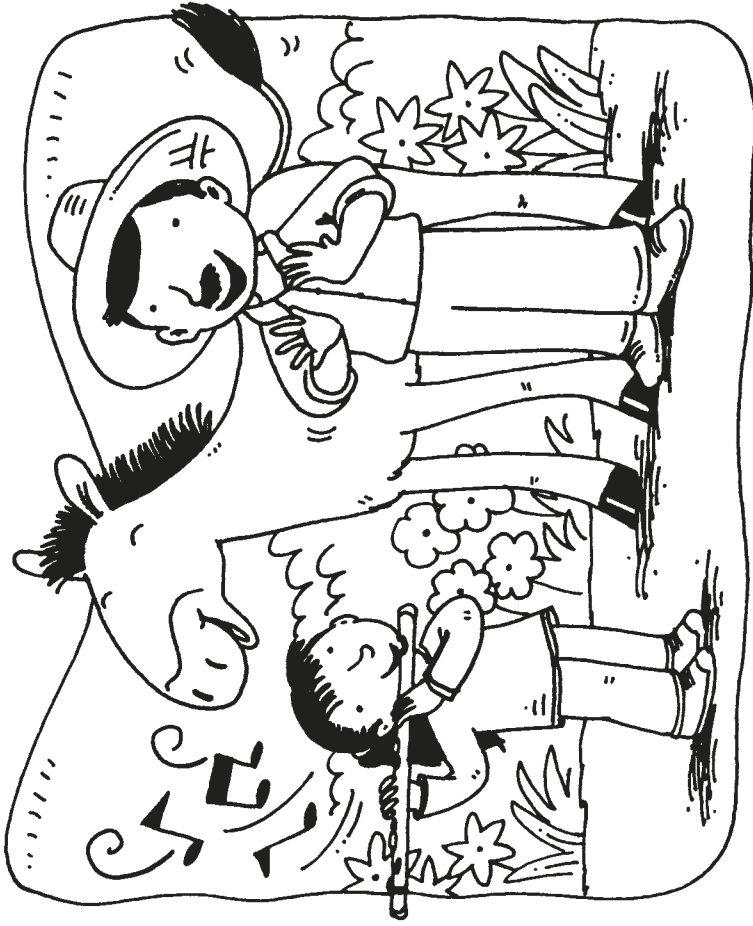















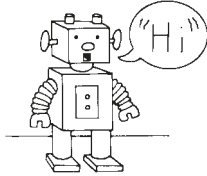

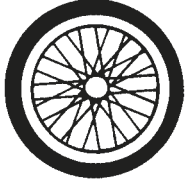
Gray likes Kay's tunes.
Dad claps. Gray taps.
“Look at Gray!” said Kay.

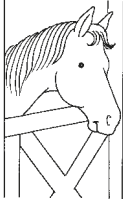
Comprehension: What did you predict
would happen when Kay played?

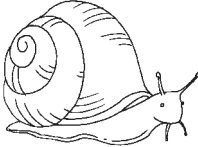
3

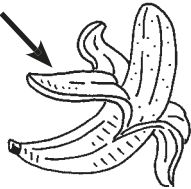
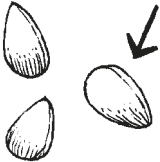

Name _____

Say the name of each picture. Circle the picture whose name has the same long e sound as the first picture.

1. 			
2. 			
3. 			
4. 			
5. 			

Name _____

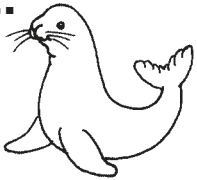
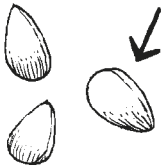
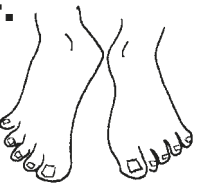
Look at each picture. Use the letter tiles to write each picture name.

<div style="border: 1px solid black; border-radius: 10px; padding: 5px; text-align: center; width: 40px; height: 40px; margin-bottom: 5px;">l</div> <div style="border: 1px solid black; border-radius: 10px; padding: 5px; text-align: center; width: 40px; height: 40px; margin-bottom: 5px;">f</div> <div style="border: 1px solid black; border-radius: 10px; padding: 5px; text-align: center; width: 40px; height: 40px;">s</div>	<p>1. </p>	<div style="border: 1px solid black; border-radius: 10px; padding: 5px; text-align: center; width: 40px; height: 40px; margin-right: 5px;">l</div> <div style="border: 1px solid black; border-radius: 10px; padding: 5px; text-align: center; width: 40px; height: 40px; margin-right: 5px;">e</div> <div style="border: 1px solid black; border-radius: 10px; padding: 5px; text-align: center; width: 40px; height: 40px; margin-right: 5px;">a</div> <div style="border: 1px solid black; border-radius: 10px; width: 40px; height: 40px;"></div>
	<p>2. </p>	<div style="border: 1px solid black; border-radius: 10px; width: 40px; height: 40px;"></div> <div style="border: 1px solid black; border-radius: 10px; padding: 5px; text-align: center; width: 40px; height: 40px; margin-right: 5px;">e</div> <div style="border: 1px solid black; border-radius: 10px; padding: 5px; text-align: center; width: 40px; height: 40px; margin-right: 5px;">a</div> <div style="border: 1px solid black; border-radius: 10px; width: 40px; height: 40px;"></div>
<div style="border: 1px solid black; border-radius: 10px; padding: 5px; text-align: center; width: 40px; height: 40px; margin-bottom: 5px;">f</div> <div style="border: 1px solid black; border-radius: 10px; padding: 5px; text-align: center; width: 40px; height: 40px; margin-bottom: 5px;">s</div> <div style="border: 1px solid black; border-radius: 10px; padding: 5px; text-align: center; width: 40px; height: 40px; margin-bottom: 5px;">t</div> <div style="border: 1px solid black; border-radius: 10px; padding: 5px; text-align: center; width: 40px; height: 40px; margin-bottom: 5px;">d</div> <div style="border: 1px solid black; border-radius: 10px; padding: 5px; text-align: center; width: 40px; height: 40px; margin-bottom: 5px;">m</div> <div style="border: 1px solid black; border-radius: 10px; padding: 5px; text-align: center; width: 40px; height: 40px;">r</div>	<p>3. </p>	<div style="border: 1px solid black; border-radius: 10px; width: 40px; height: 40px;"></div> <div style="border: 1px solid black; border-radius: 10px; padding: 5px; text-align: center; width: 40px; height: 40px; margin-right: 5px;">e</div> <div style="border: 1px solid black; border-radius: 10px; padding: 5px; text-align: center; width: 40px; height: 40px; margin-right: 5px;">e</div> <div style="border: 1px solid black; border-radius: 10px; width: 40px; height: 40px;"></div>
	<p>4. </p>	<div style="border: 1px solid black; border-radius: 10px; width: 40px; height: 40px;"></div> <div style="border: 1px solid black; border-radius: 10px; padding: 5px; text-align: center; width: 40px; height: 40px; margin-right: 5px;">e</div> <div style="border: 1px solid black; border-radius: 10px; padding: 5px; text-align: center; width: 40px; height: 40px; margin-right: 5px;">e</div> <div style="border: 1px solid black; border-radius: 10px; width: 40px; height: 40px;"></div>
	<p>5. </p>	<div style="border: 1px solid black; border-radius: 10px; width: 40px; height: 40px;"></div> <div style="border: 1px solid black; border-radius: 10px; width: 40px; height: 40px;"></div> <div style="border: 1px solid black; border-radius: 10px; padding: 5px; text-align: center; width: 40px; height: 40px; margin-right: 5px;">e</div> <div style="border: 1px solid black; border-radius: 10px; padding: 5px; text-align: center; width: 40px; height: 40px;">e</div>
	<p>6. </p>	<div style="border: 1px solid black; border-radius: 10px; width: 40px; height: 40px;"></div> <div style="border: 1px solid black; border-radius: 10px; padding: 5px; text-align: center; width: 40px; height: 40px;">e</div>

Name _____

A. Read the words in the box. Write one word on each line.

give

across

says

again

1. _____

2. _____

3. _____

4. _____

B. Use a word from the box to finish each sentence.

1. Did you _____ the dog a bone?



2. Matt lives _____ the street.

3. Fox _____ he wants to eat.

4. Pete will take the test _____.

Name _____

The **characters** are the people or animals in the story.
The **setting** is where the story takes place.

As you read “Up a Tree,” fill in the Character and Setting Chart.

Setting	What the Characters Do There

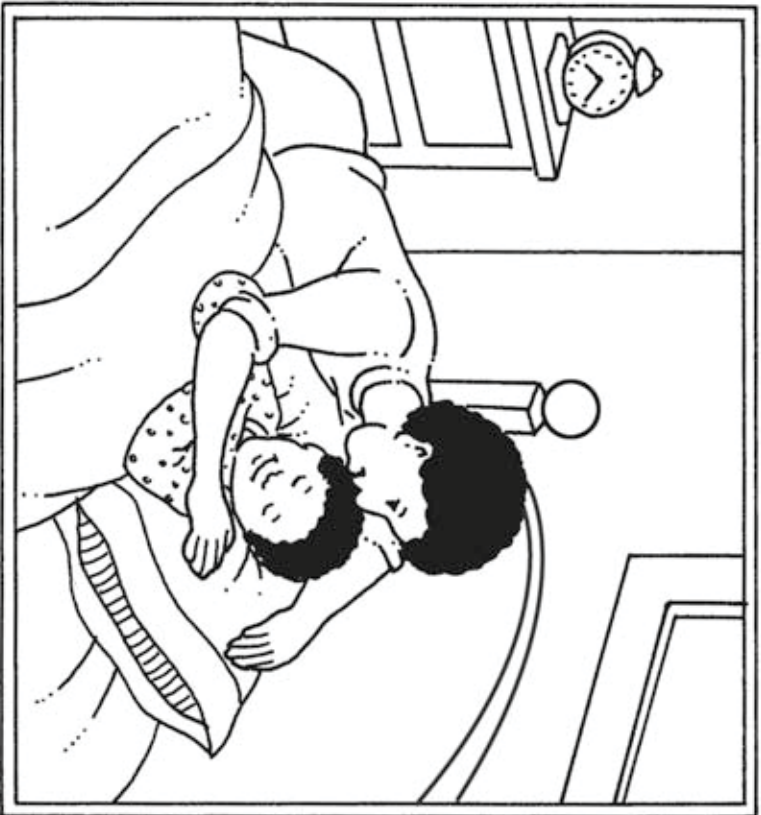

Pete hugs Mom.

Mom kisses Pete.

“A kiss is what I need,” says Pete. “Now I will sleep.”

Sweet Dreams, Pete!

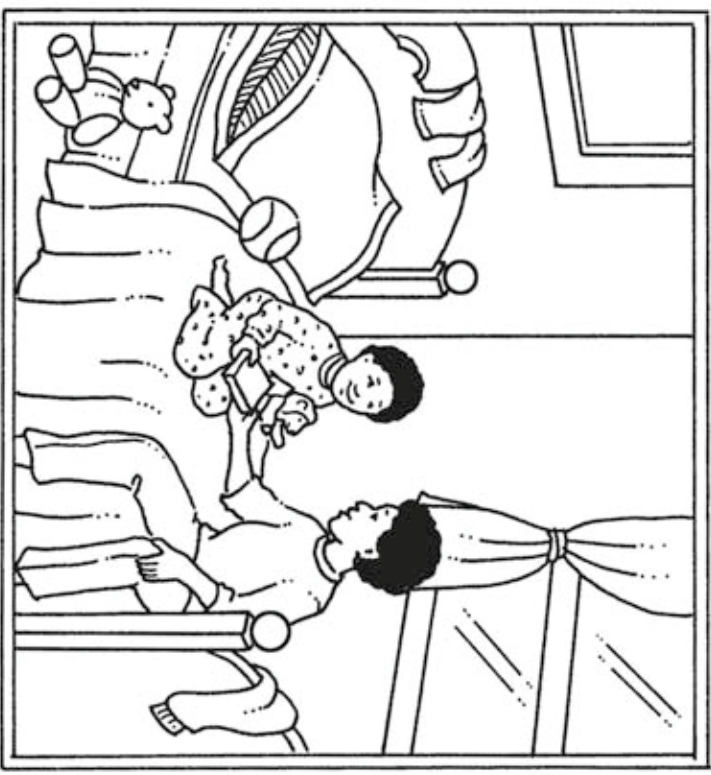

Pete will not sleep.

“Read to me,” says Pete.

“Fine,” says his mom.

“But then you must sleep.”





Pete will not sleep.

“Give me a snack,” says Pete.

“Fine,” says Pete’s mom.

“Then you must sleep.”

Phonics: Underline the words in the story that have **long e** spelled **e**, **ea**, and **ee**.



Pete will not sleep.









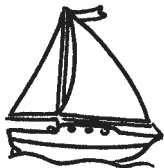
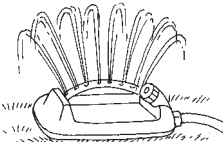

“I need something to take with me,” says Pete.

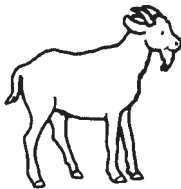
“What will it be?” asks Pete’s mom.

Comprehension: How would you describe Pete?

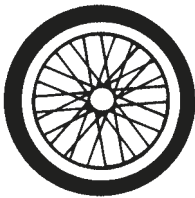
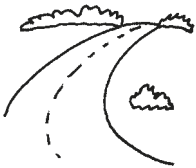
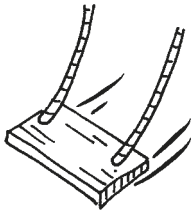
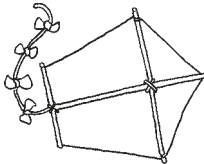
Name _____

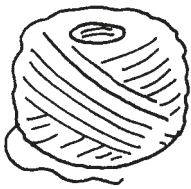
Say the name of each picture. Circle the picture whose name has the same long o sound as the first picture.

1. 			
2. 			
3. 			
4. 			

Name _____

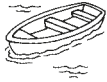

boat









go



bowl

Circle the word that names each picture. Then write the word on the line. Underline the letters that make the long o sound.

<p>1.  coat close cot</p> <p>_____</p> <p>coat</p> <p>_____</p>	<p>2.  bow flow blow</p> <p>_____</p> <p>_____</p> <p>_____</p>	<p>3.  swing stop soap</p> <p>_____</p> <p>_____</p> <p>_____</p>
<p>4.  roll row skip</p> <p>_____</p> <p>_____</p> <p>_____</p>	<p>5.  grab goat got</p> <p>_____</p> <p>_____</p> <p>_____</p>	<p>6.  fold fix flat</p> <p>_____</p> <p>_____</p> <p>_____</p>

Name _____

A. Read the words in the box. Write one word on each line.

about

people

move

by

1. _____

2. _____

3. _____

4. _____

B. Use a word from the box to finish each sentence.

1. Some _____ like to sing.

2. She sits _____ me on the bus.

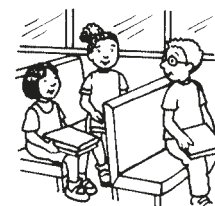

3. This is _____ cats.

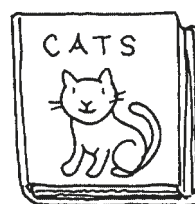

4. I can _____ the big box.

Name _____

Retelling a story helps you remember the most important parts. You can then share the story with others.

As you read “Let’s Go!,” fill in the Retelling Chart.

Let’s Go!**Beginning**

1.	→	2.
----	---	----

Middle

3.	→	4.
----	---	----

Ending

5.	→	6.
----	---	----

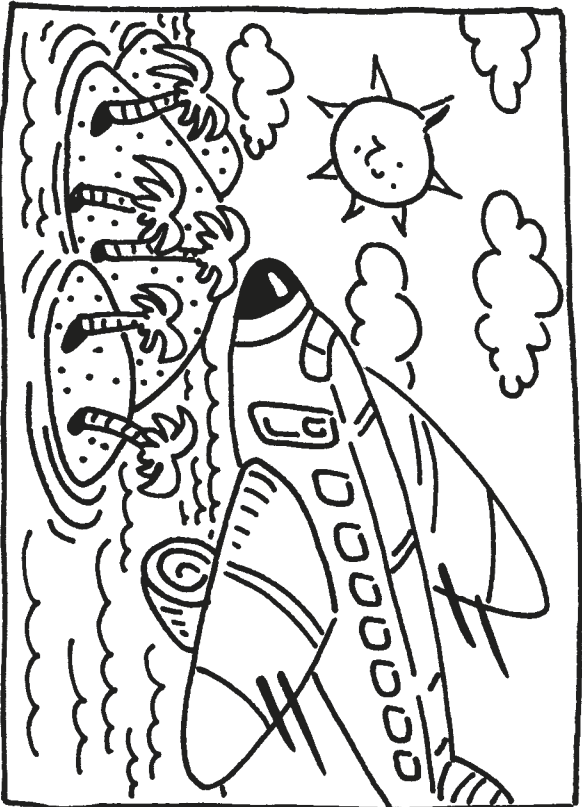

A plane is not slow.
A plane is a fast way to go.
Which ways do you go?

Go, Go, Go!

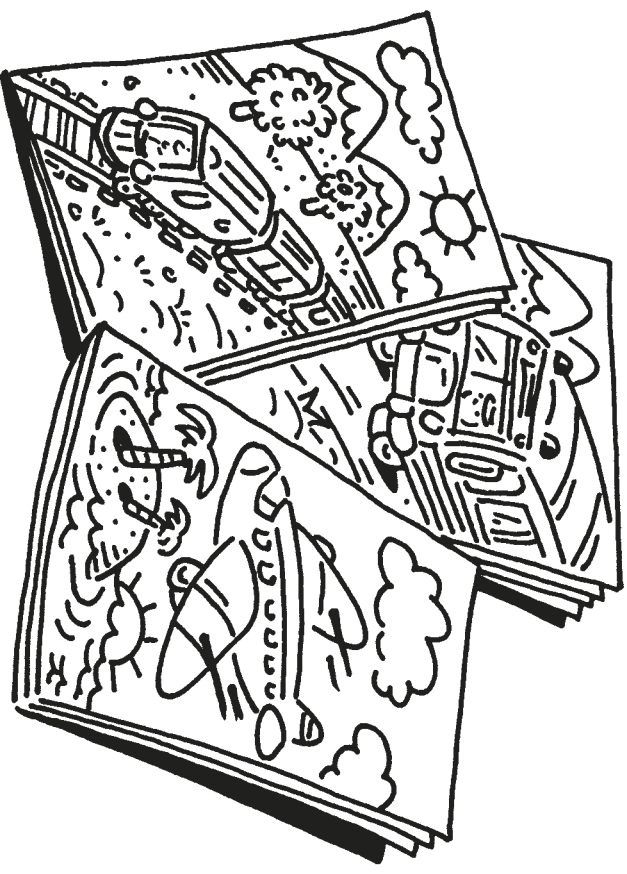

Go, go, go!
People go in so many ways.





We can go by bus.

A bus drives on a road.

It can be a slow way to go.

Phonics: Draw a line under words that have long o spelled oa, ow, or o.

2

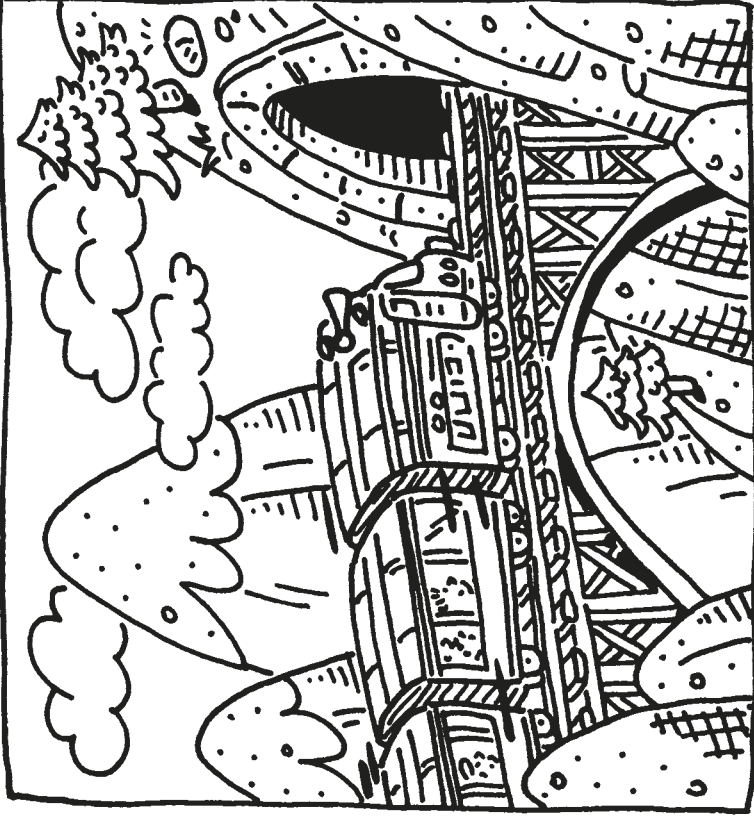

A train is a fast way to go.

A train rides on a track.











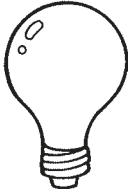
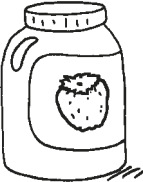

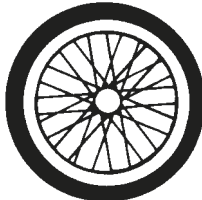

It can take a big load.

Comprehension: What ways to go have you read about so far?

3

Name _____

Say the name of each picture. Circle the picture whose name has the same long i sound as the first picture.

<p>1.</p> 			
<p>2.</p> 			
<p>3.</p> 			
<p>4.</p> 			

Name _____



wind

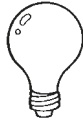

light



fry

Look at each picture. Write the picture name on the line. Circle the letters that make the long i sound in each word.

night

cry

fly

wind

bright

sky

1.



bright

2.



3.



4.



5.



6.



Name _____

A. Read the words in the box. Write one word on each line.

every

should

never

out

1. _____

2. _____

3. _____

4. _____

B. Use a word from the box to finish each sentence.

1. _____ bee lives in a hive.



2. I _____ cross that street.

3. Did you let the cat _____ ?

4. People _____ keep fit.



Name _____

Stories have a **beginning**, a **middle**, and an **end**.

As you read “The Light,” fill in the Plot Chart.

Beginning



Middle



End

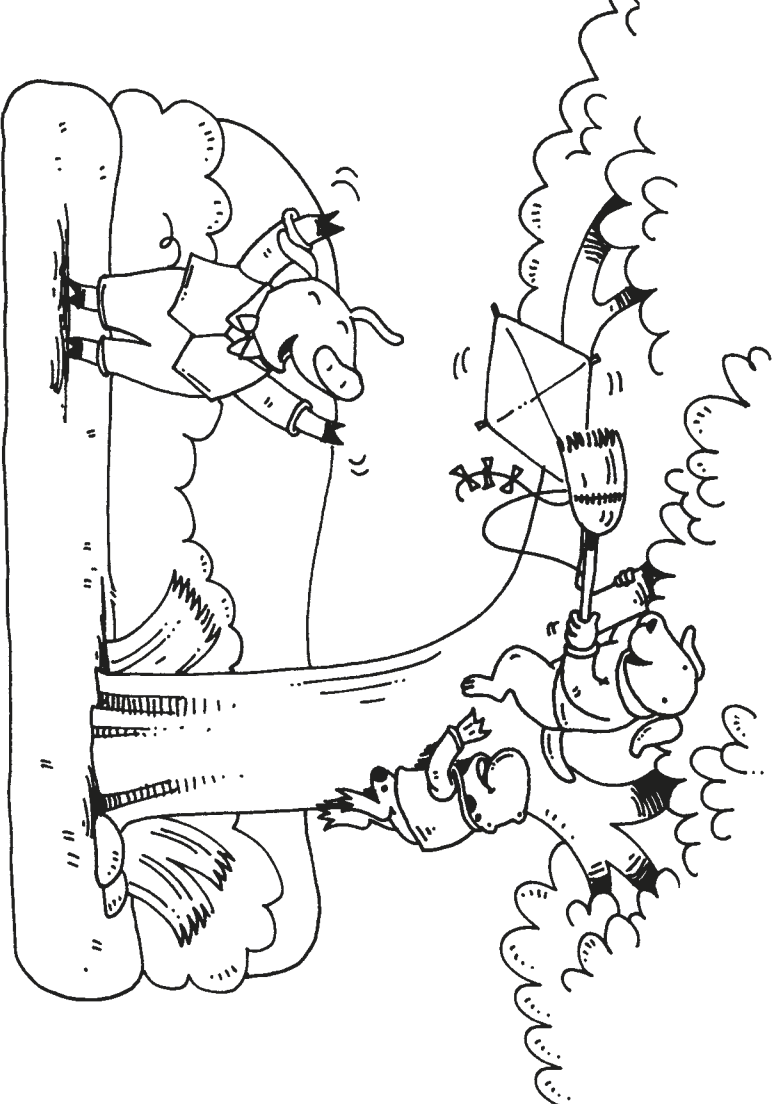

Pig Can Fly a Kite

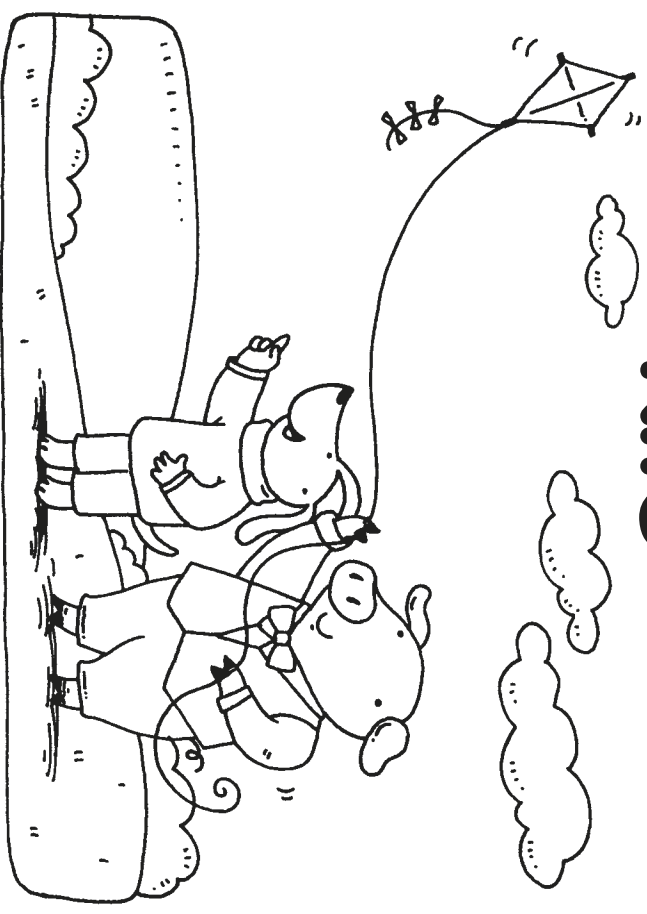

Frog gave the broom to Dog.
Then Dog got Pig's kite.

"Thanks so much," said Pig.

"I have such kind pals!"

High-Frequency Words:

Circle the words out and

never in the story.



At Home: Ask your child to read the book aloud to you.

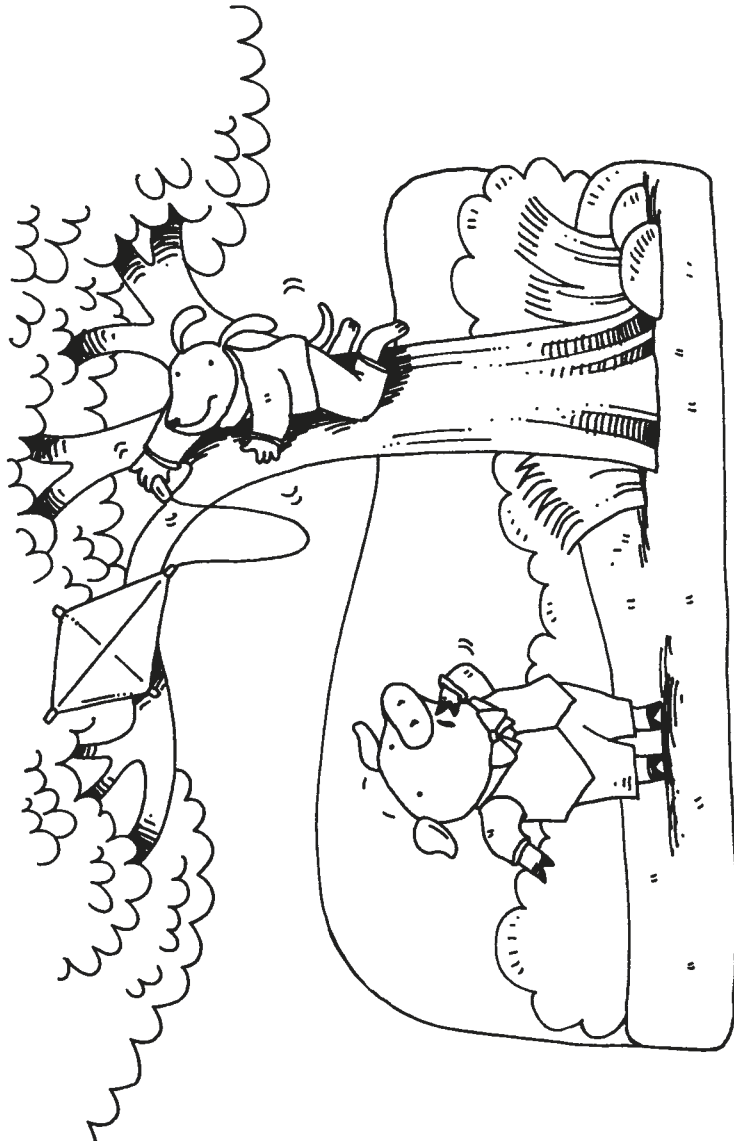

Then Pig's kite got stuck.
It was high up in a tree.
Dog went up to get it.
"Don't slip, Dog!" Pig yelled.

Phonics: Draw a line under the words that have long **i** spelled **igh** or **y**.

2

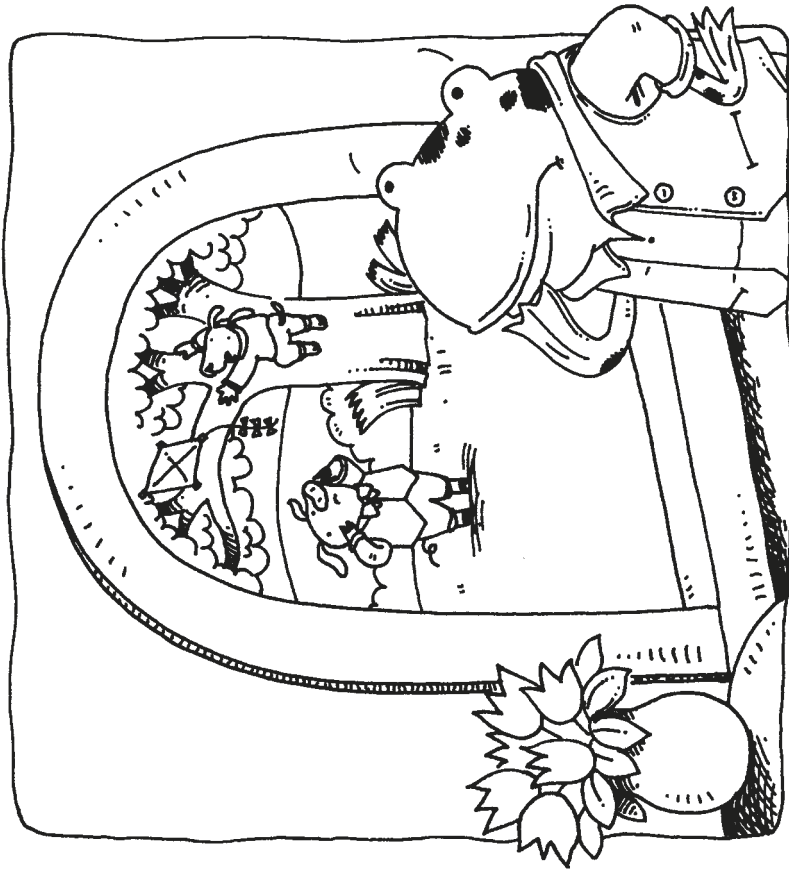













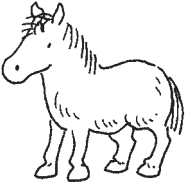
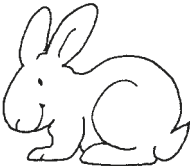

Frog looked out.
"Pig's kite is so high up," he
said. "Dog will never reach it."
So Frog got a broom.

Comprehension: What is Pig's problem?
Who helps him solve the problem?

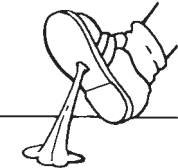
3

Name _____

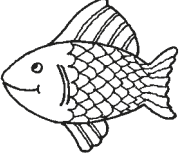
Say the name of each picture. Circle the picture whose name ends with the same long e sound as the first picture.

<p>1.</p> 	  
<p>2.</p> 	  
<p>3.</p> 	  
<p>4.</p> 	  

Name _____



puppy

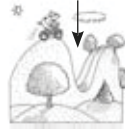

valley

Look at each picture. Write the picture name on the line. Circle the letters that make the long e sound.

baby

pony

bunny

key

penny

1.

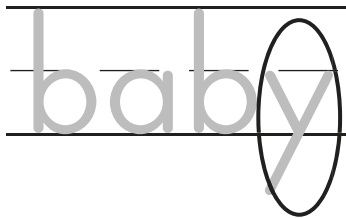

2.



3.

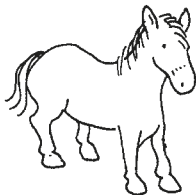

4.

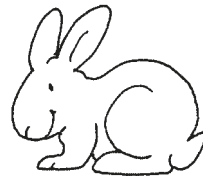

5.

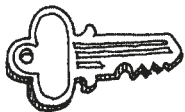

Name _____

A. Read the words in the box. Write one word on each line.

saw pull two other

- | | |
|----------------------------|----------------------------|
| 1. _____

_____ | 2. _____

_____ |
| 3. _____

_____ | 4. _____

_____ |

B. Use a word from the box to finish each sentence.

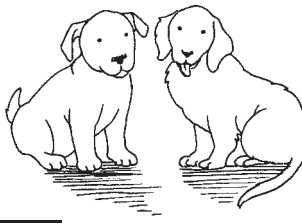
1. I have _____ dogs. 

2. Did you take my _____ sock?

3. The dog can _____ Fred.

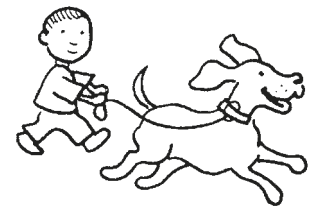

4. I _____ you jump up.

Name _____

Retelling a story helps you remember the most important parts. You can then share the story with others.

As you read “Lilly Cleans Up,” fill in the Retelling Chart.

Lilly Cleans Up

Beginning

1.	→	2.
----	---	----

Middle

3.	→	4.
----	---	----

Ending

5.	→	6.
----	---	----

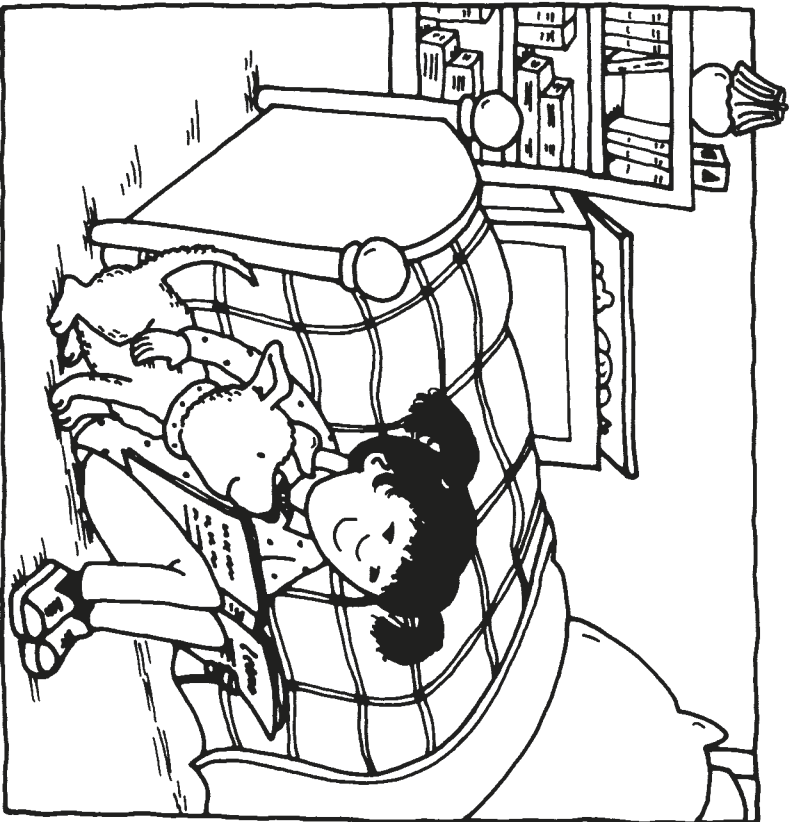

At last Milly was done
cleaning.
She was happy.

Milly and her puppy played!



At Home: Ask your
child to read the
book aloud to you.

High-Frequency Words:
Circle the words two and
other in the story.

4

Milly's Happy Puppy



Milly had a happy puppy.
He and Milly had fun
together.



Mom said, "Milly, this is messy! Clean it up. Then you two can play."
Milly was not happy.

Phonics: Draw a line under words that have long e spelled y.

2

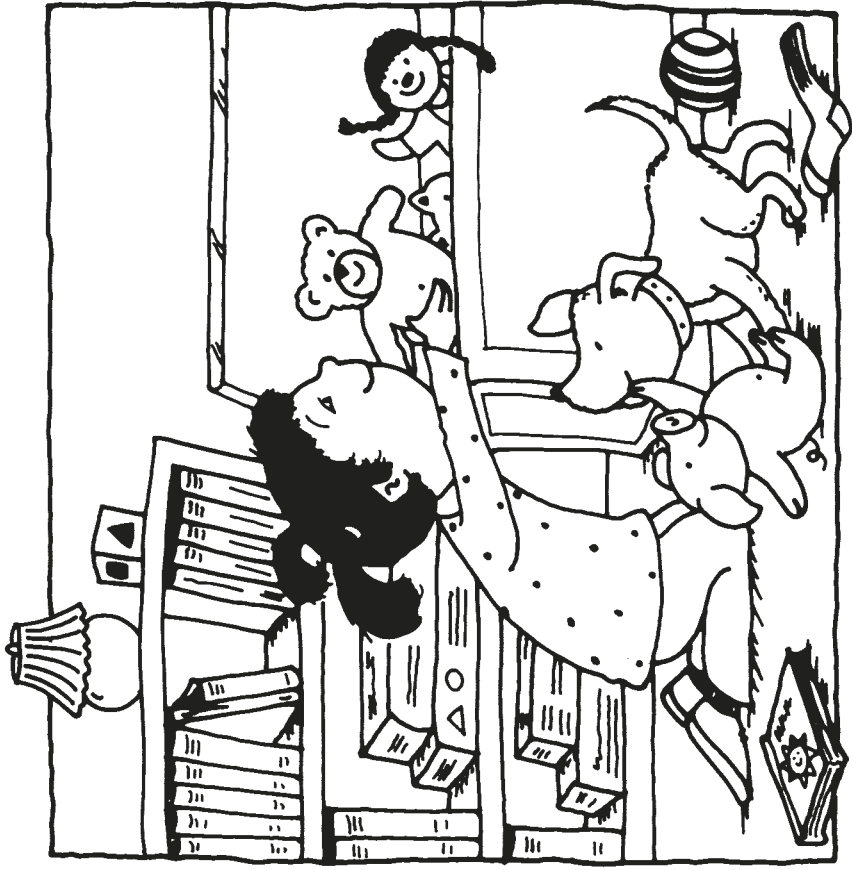









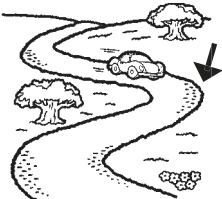
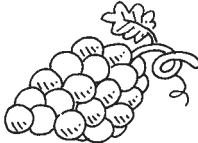
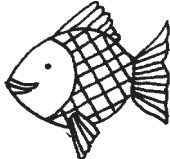

But Milly's puppy helped clean.
He picked some things up.
Milly picked other things up.

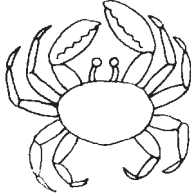
Comprehension: What do Milly and the puppy do in the middle of the story?

3

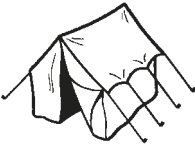
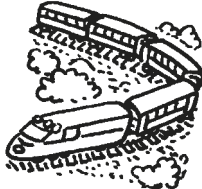
Name _____

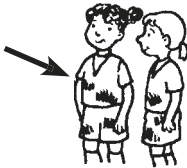
Say the name of each picture. Circle the picture whose name has the same middle sound as the first picture.

<p>1.</p> 			
<p>2.</p> 			
<p>3.</p> 			
<p>4.</p> 			

Name _____



bird





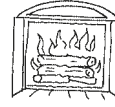



fern

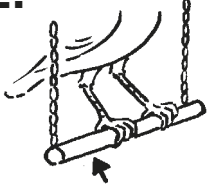

burn

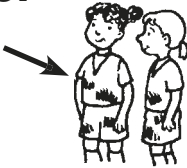
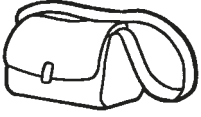
Look at each picture. Write the missing letters to finish the picture name.

<p>1.  f <u>er</u> n</p>	<p>2.  p <u>er</u> ch</p>
<p>3.  st <u>ir</u></p>	<p>4.  sk <u>irt</u></p>
<p>5.  g <u>irl</u></p>	<p>6.  d <u>is</u> t</p>
<p>7.  p <u>urse</u></p>	<p>8.  h <u>and</u> t</p>

Name _____

A. Read the words in the box. Write one word on each line.

does

also

another

from

1. _____

2. _____

3. _____

4. _____

B. Use a word from the box to finish each sentence.

1. The nest hangs _____ a branch.

2. What _____ the bird use to make it?

3. The bird _____ uses sticks.

4. There is _____ nest in the tree.

Name _____

Comprehension:
Cause/Effect

A **cause** is what makes something happen.
An **effect** is what happens.

As you read “Birds’ Nests,” fill in the Cause and Effect Chart.

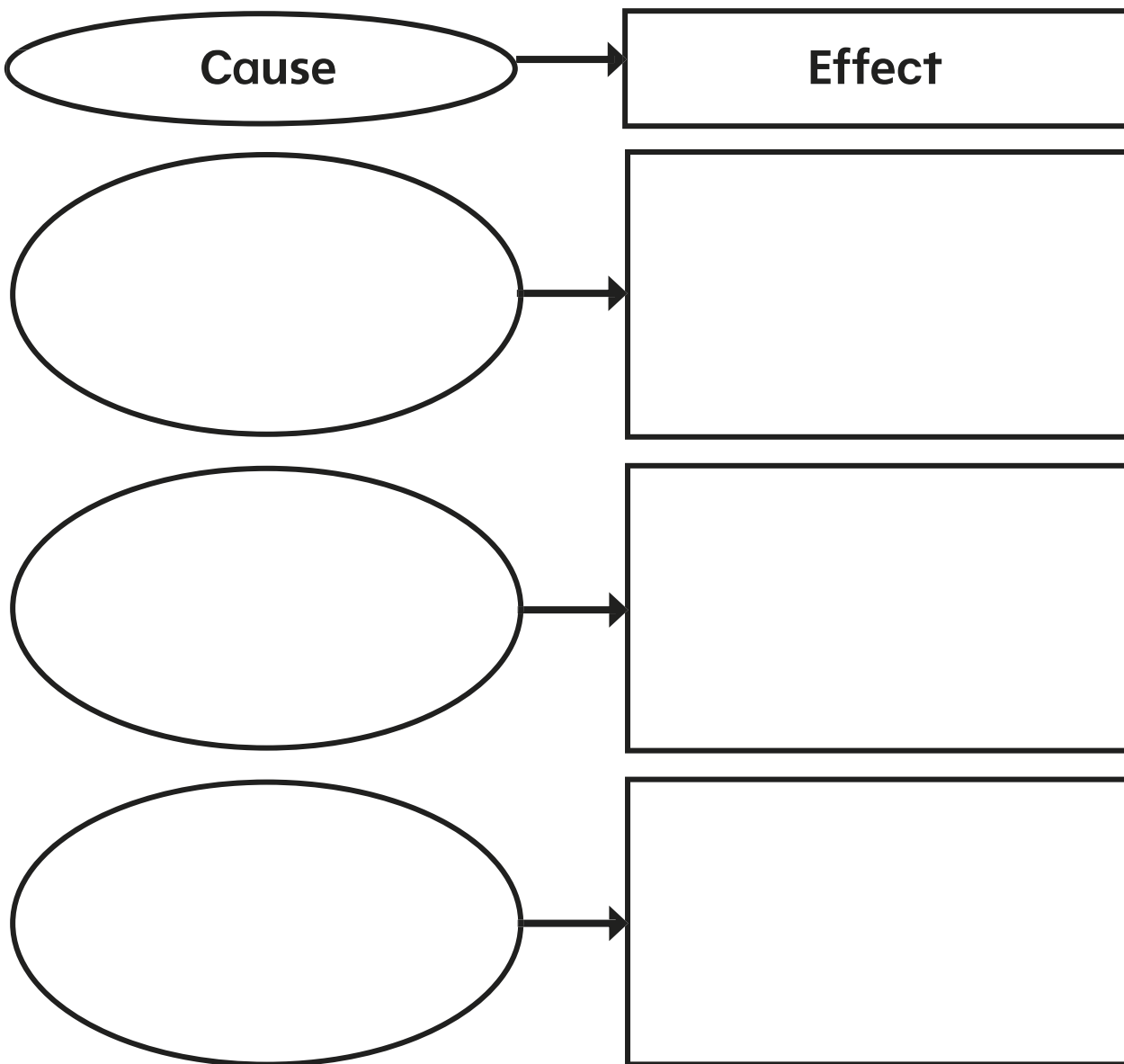

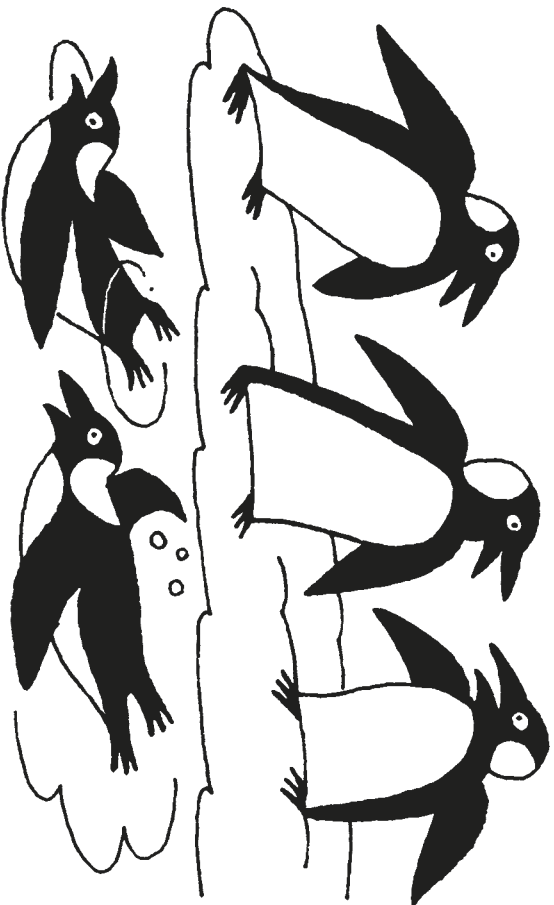

A penguin is a bird. But it does not fly. This bird has flippers and webbed feet that help it swim. It walks and slides on the ice, too.

High-Frequency Words:
Circle the words from and does in the story.



At Home: Ask your child to read the book aloud to you.

Birds, Birds, Birds

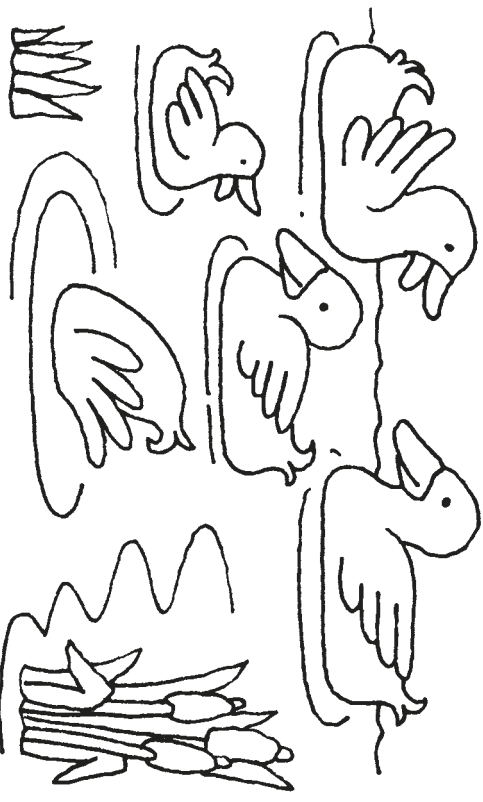

Ducks live in rivers, lakes, and ponds. A duck's webbed feet help it swim. It dips its bill to eat plants and bugs.

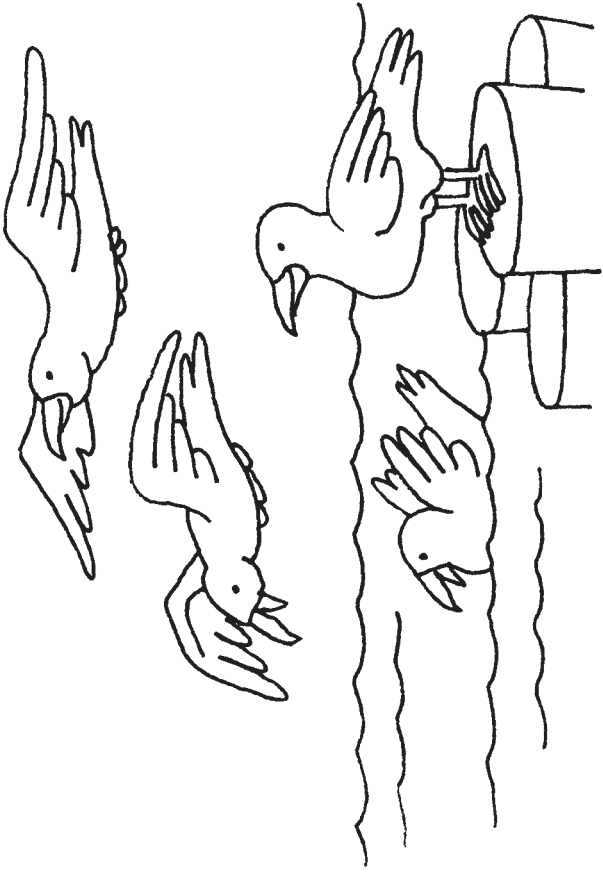

Seagulls live by the sea.

In winter, this bird flies to get away from the cold. It goes to a warm spot. Then it flies back in summer.

Phonics: Underline the words in the story that have the same vowel sound you hear in her, stir, and fur.

2



An owl is a hunter. This bird likes to hunt at night. It sees well in dim light. It hears well, too.

Comprehension: What causes the seagull to fly far away in winter?

3

Name _____

Say the name of each picture. Circle the picture whose name has the same vowel sound as the first picture.

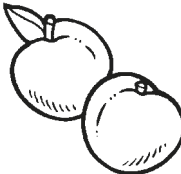
1. 			
2. 			
3. 			
4. 			
5. 			

Name _____

car

Finish each word ladder. Change only one letter at a time.

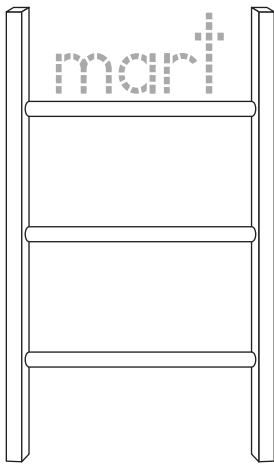
1. Go from **mart** to **bark**.

Hints:

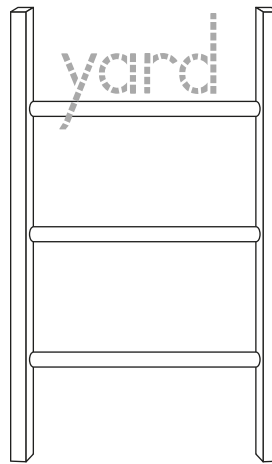
Change
t to k.2. Go from **yard** to **barn**.

Hints:

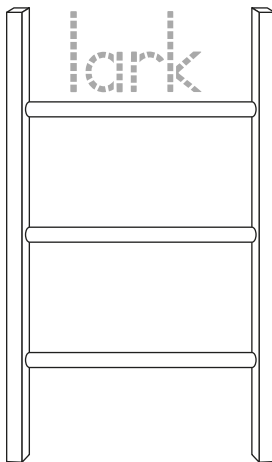
Change
d to n.3. Go from **lark** to **part**.

Hint:

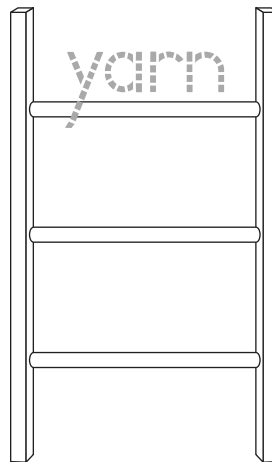
Change
l to p.4. Go from **yarn** to **hard**.

Hint:

Change
n to d.

Name _____

A. Read the words in the box. Write one word on each line.

better

knew

were

any

1. _____

2. _____

3. _____

4. _____

B. Use a word from the box to finish each sentence.

1. We _____ the way to the park.

2. We _____ at the park.

3. Was it _____ than the farm?

4. I can go to the farm _____ day I want.



Name _____

Comprehension:
Make Inferences

Good readers use what they already know and what they learn from what they read to **make inferences**.

As you read “At the Big Park,” fill in the Inference Chart.

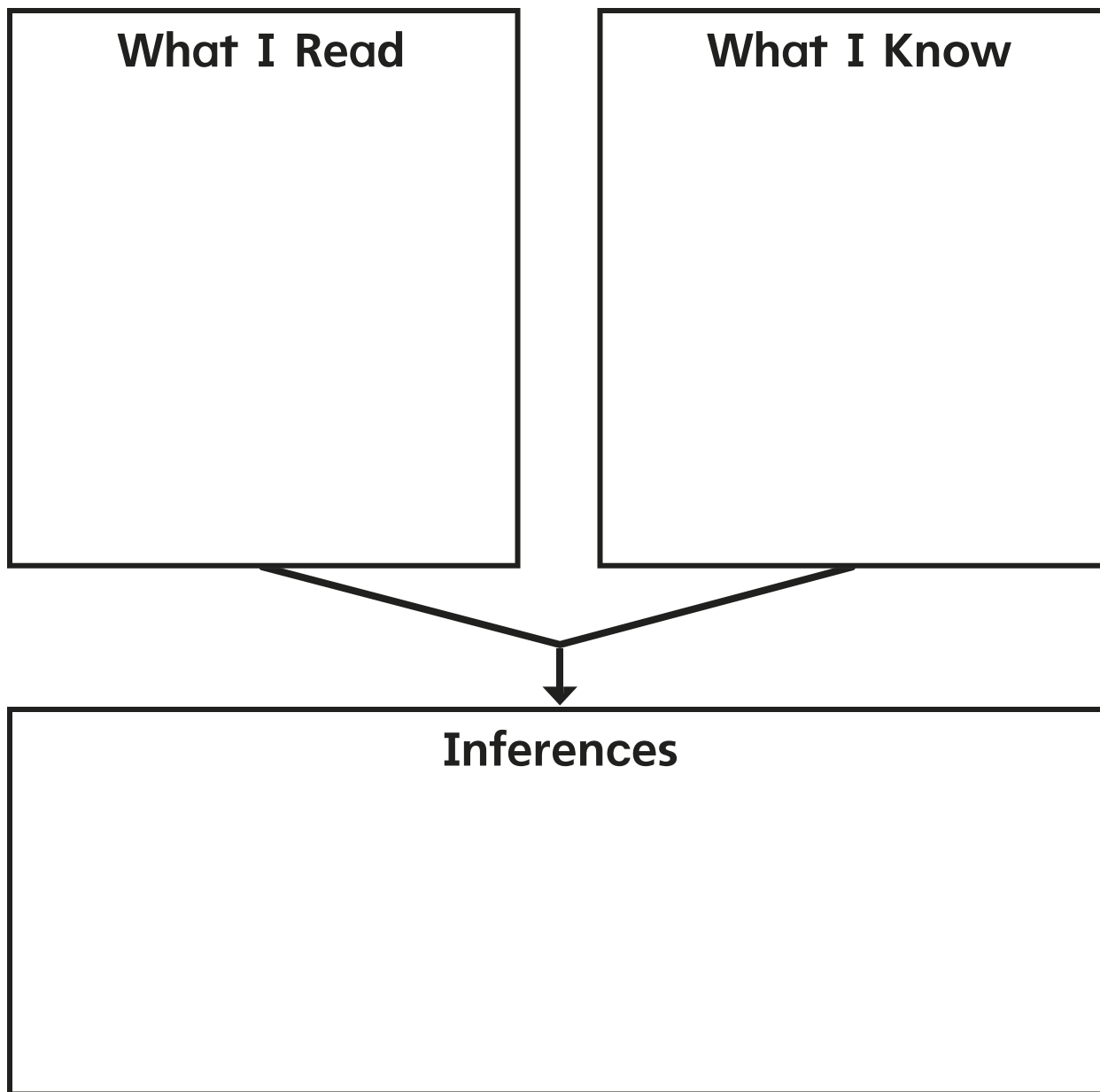

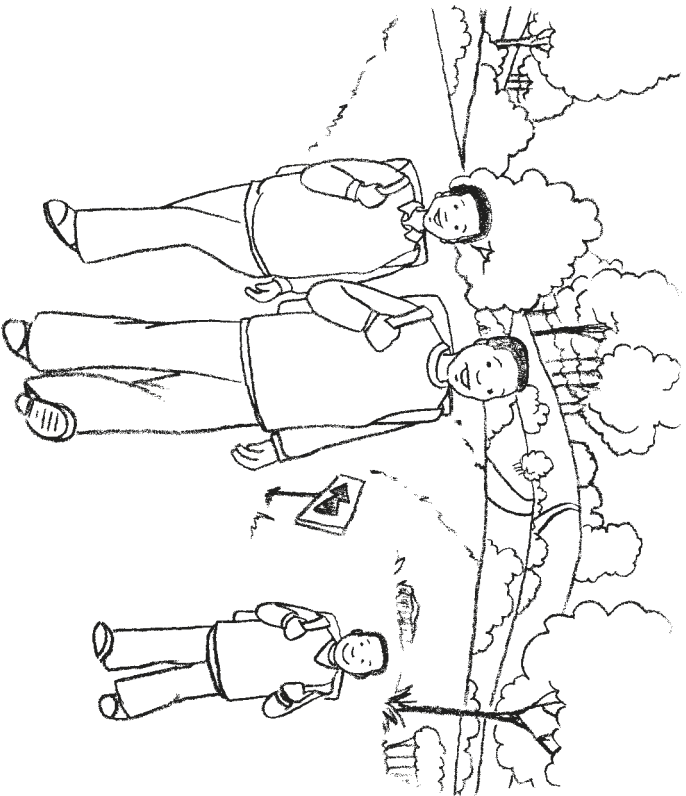

A while later, the hikers went back. They had hiked three miles. Mark felt tired, but happy!

High-Frequency Words:
Circle the words were and better in the story.



At Home: Ask your child to read the book aloud to you.

A Hike in the Park

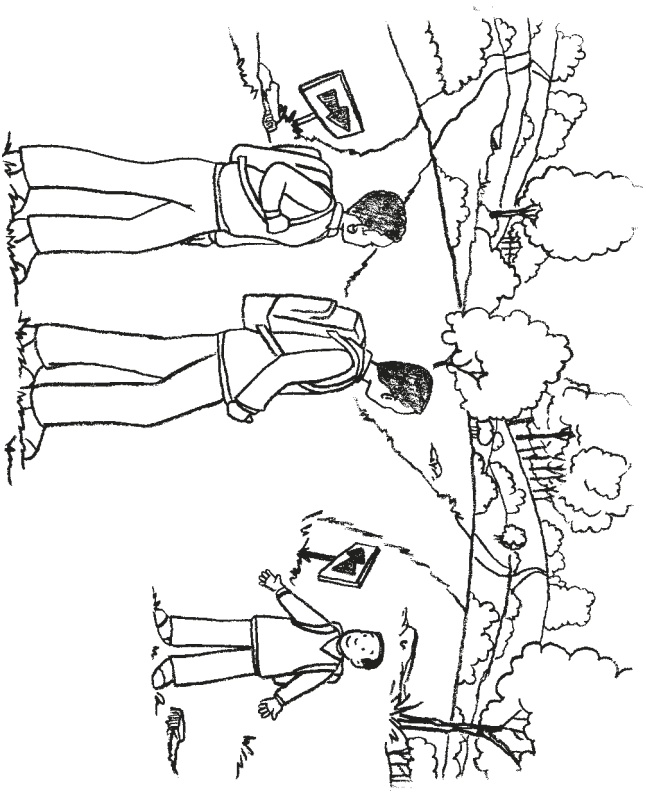

Mom and Dad and Mark were hiking in a park. “Let’s take that trail,” said Mom.

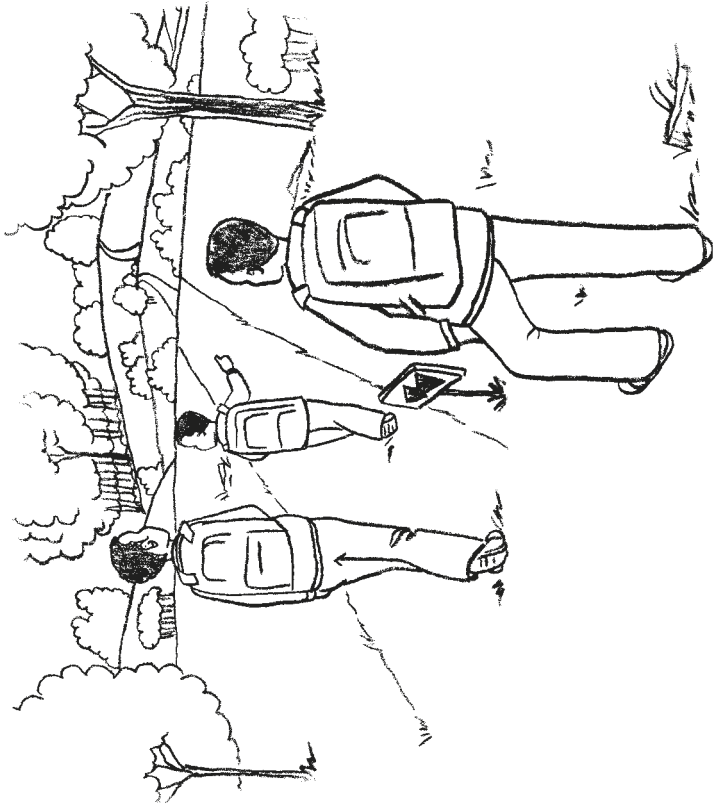

“This trail looks better!”
said Mark.

The three hikers started up
the trail. They went far.

Phonics: Underline the words in the story
that have **ar** as in car.

2

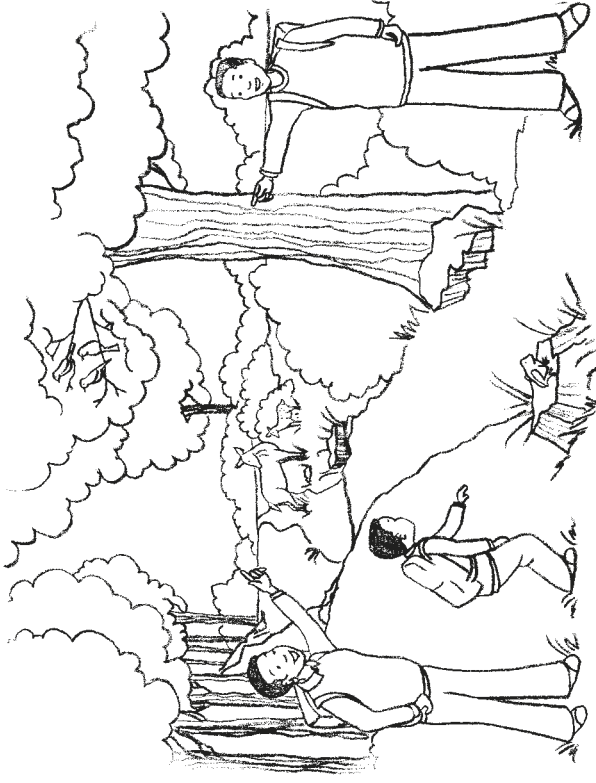











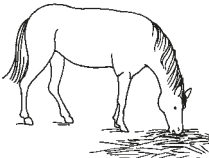

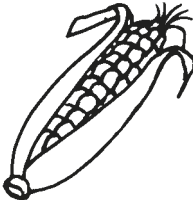
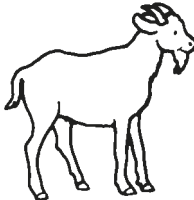

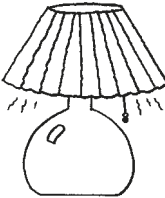
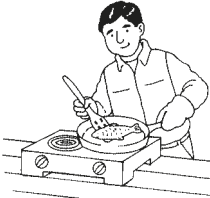
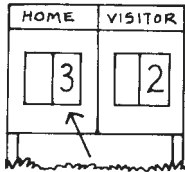
“Look at that deer with its
mom!” said Dad.
“I see three larks in the tree!”
said Mom.
“I see a big frog!” said Mark.

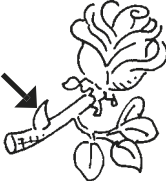
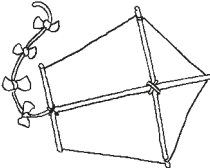
Comprehension: How does Mark’s family
feel about their hike?

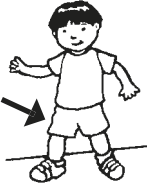
3

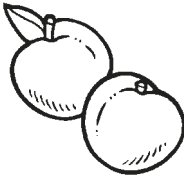
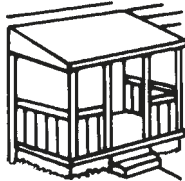
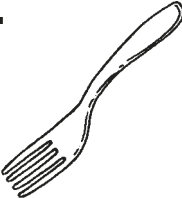
Name _____

Say the name of each picture. Circle the picture whose name has the same vowel sounds as the first picture.

<p>1.</p> 			
<p>2.</p> 			
<p>3.</p> 			
<p>4.</p> 			
<p>5.</p> 			

Name _____





horn

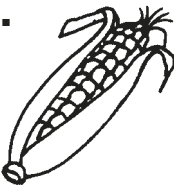

shore

Look at each picture. Use the letter tiles to complete each picture name.

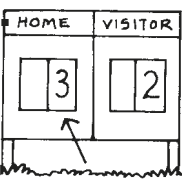
o	1. 	h			n
r	2. 	c			
k	3. 	f			
n	4. 	s	t		k
e	5. 	s	c		

Name _____

A. Read the words in the box. Write one word on each line.

great

because

warm

would

1. _____

2. _____

3. _____

4. _____

B. Use a word from the box to finish each sentence.

1. Sunday was _____ and sunny.

2. It was a _____ game!



3. He was out _____ he got three strikes.

4. I _____ like to play the game, too.

Name _____

When we look at how two things are the same, we **compare** them. When we look at how they are different, we **contrast** them.

As you read “Fun with Sports,” fill in the Compare and Contrast Chart.

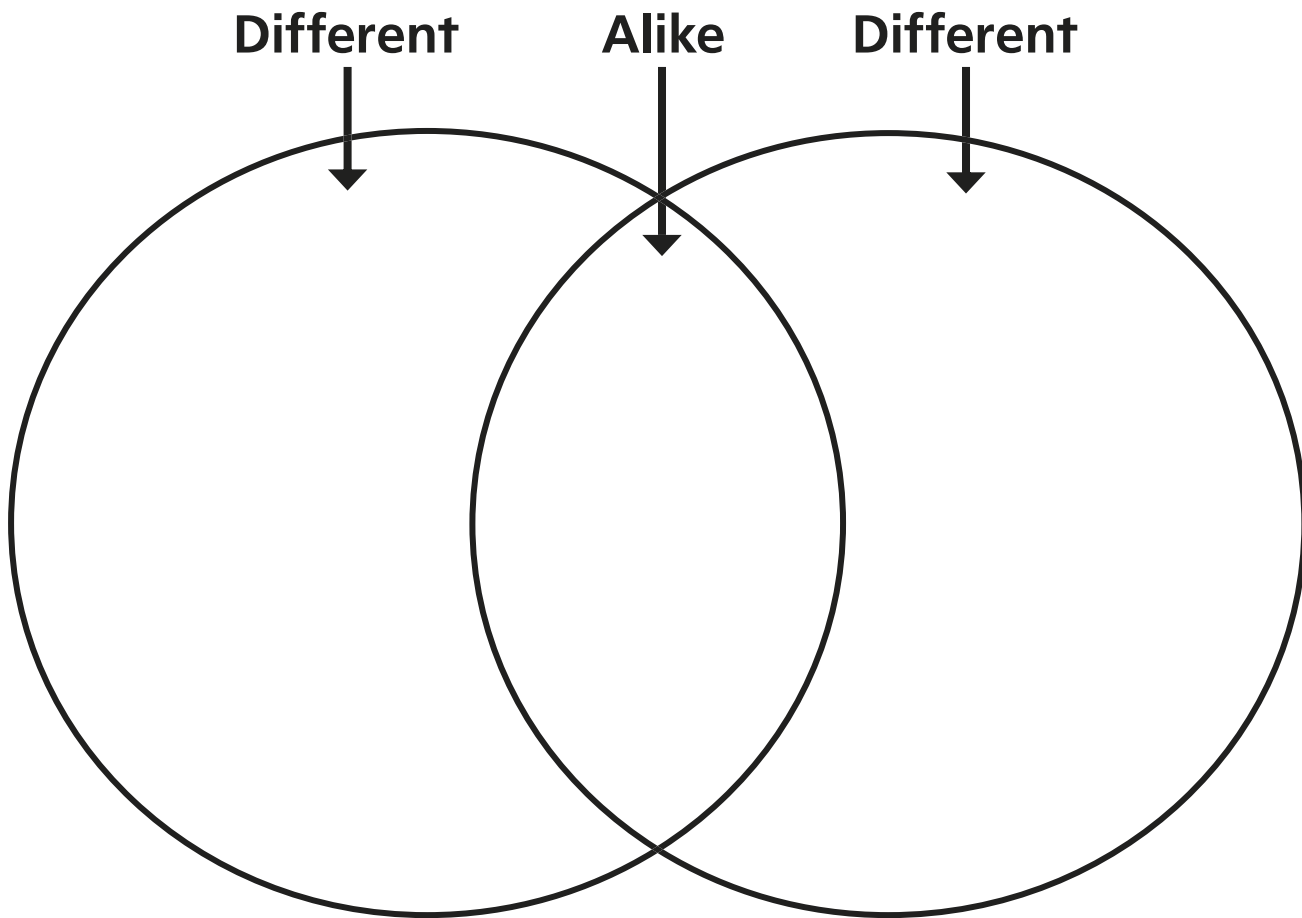

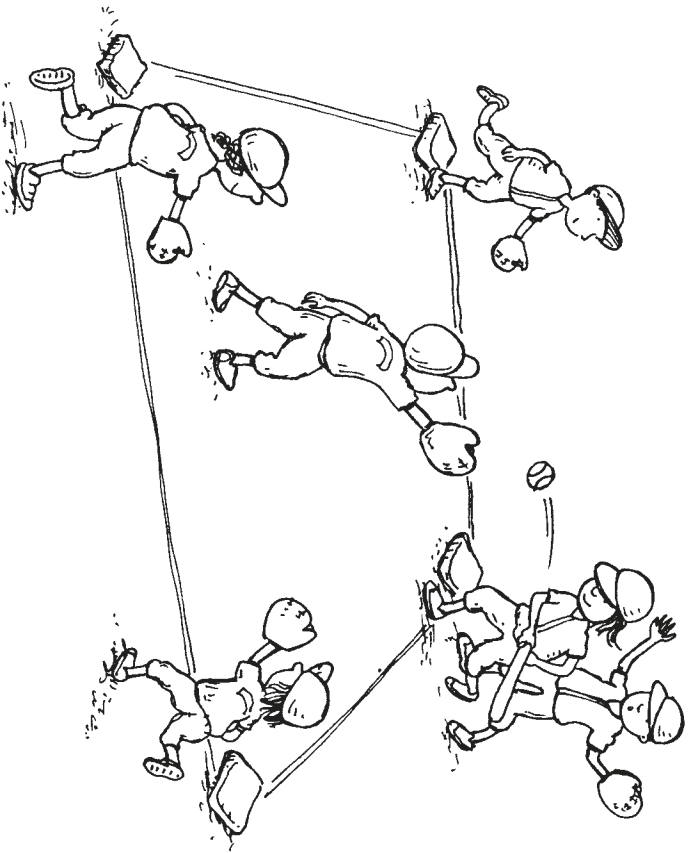

Most kids like team sports.
That batter made a great
hit! She will run around
the bases. Will she make a
home run?

High-Frequency Words:
Circle the words great
and would in the story.



At Home: Ask your
child to read the
book aloud to you.

Pick a Sport!



All sorts of sports can
be fun. Pick a sport
that you like. Then try
to play it!

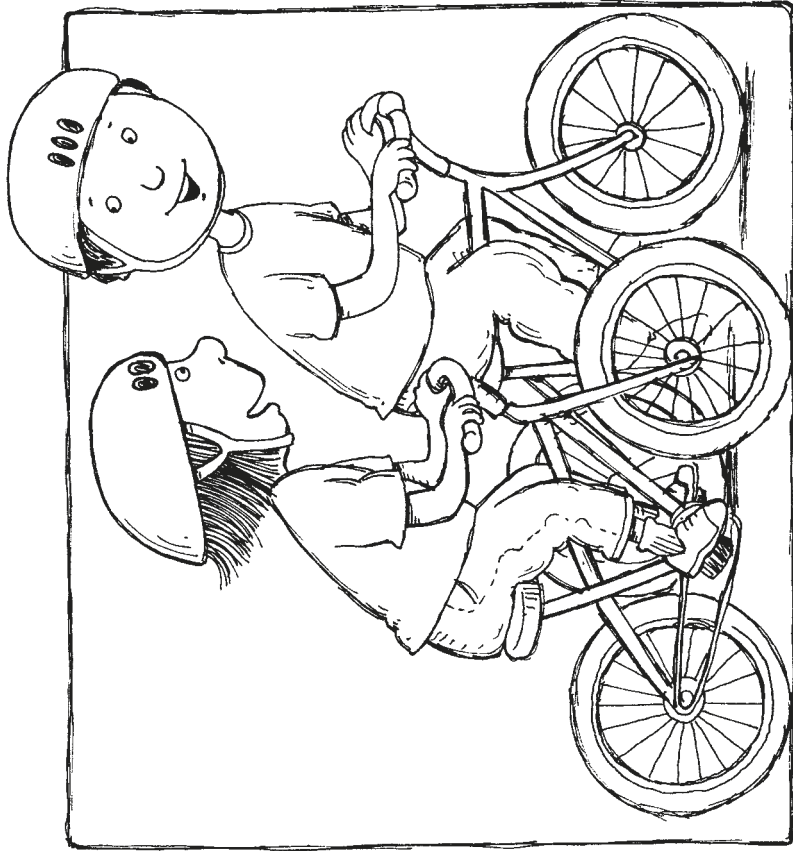

Riding a bike is a fun sport. You can ride by yourself or ride with a pal. Is this the sort of sport you would like?

Phonics: Underline the words in the story that have **or** as in short.

2

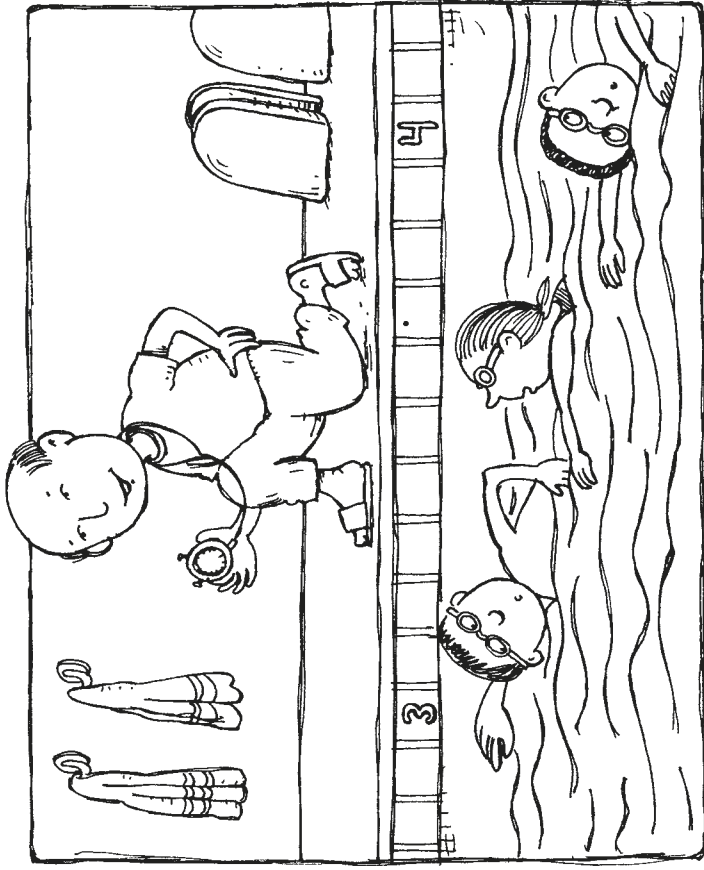











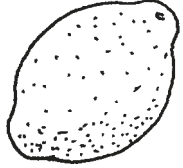
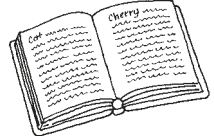

The coach teaches the team to swim fast and dive. Today they swim back and forth. Is this sport for you?

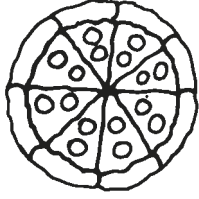
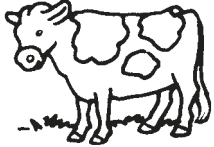
Comprehension: How are swimming and riding a bike the same?

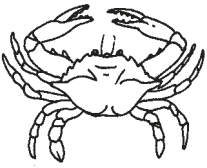
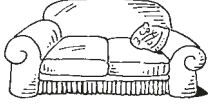
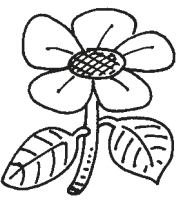
3

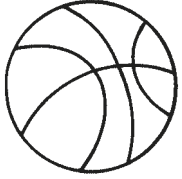
Name _____

Say the name of each picture. Circle the picture whose name has the same vowel sound as the first picture.

1.				
2.				
3.				
4.				
5.				

Name _____



mouth





COW

Look at each picture. Write the picture name on the line. Underline the letters that make the /ow/ sound.

mouse down house ground cow clown

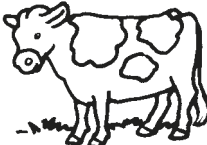
1.  _____
mouse

2.  _____

3.  _____

4.  _____

5.  _____

6.  _____

Name _____

A. Read the words in the box. Write one word on each line.

once

upon

fall

buy

1. _____

2. _____

3. _____

4. _____

B. Use a word from the box to finish each sentence.

1. You use money to _____ things.



2. _____ I held a monkey!

3. Watch out or you will _____ !

4. The king sat _____ a throne.

Name _____

Sequence is what happens first, next, and last in a story.

As you read “Jack and the Beans,” fill in the Sequence Chart.

First
↓
Next
↓
Last

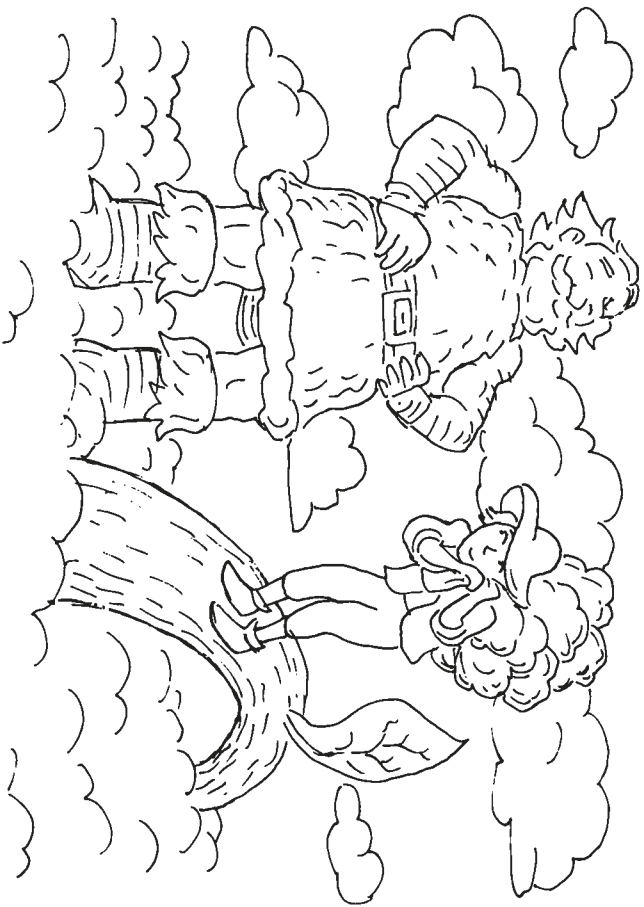

The huge man counted out
ten bags of gold.

“Take this for the town,”
he said.

Jack thanked him. In the
town, the crowd cheered!

High-Frequency Words:

Circle the words once,

upon, and buy in the story.



At Home: Ask your
child to read the
book aloud to you.

Gold for Jack's Town



Once upon a time, Jack
planted beans. A big
bean plant rose up to the
clouds! Jack went up the
bean plant.



Jack said, "Please, Sir, our town needs help. We need to buy two cows. We need to fix our houses. Will you help us?"

Comprehension: What happened after Jack planted the beans?

3

© Macmillan/McGraw-Hill















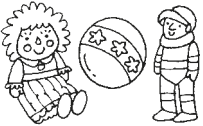

At the top, Jack spotted a huge man. He was counting his gold. The man shouted, "How did you get here? Get out now!"

Phonics: Draw a line under words that have the same vowel sound you hear in cow and house.

2

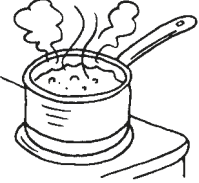
Name _____

Say the name of each picture. Circle the picture whose name has the same vowel sound as you hear in the first picture.

<p>1.</p> 			
<p>2.</p> 			
<p>3.</p> 			
<p>4.</p> 			

Name _____



joy

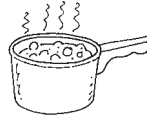

boil

A. Look at each picture. Write the picture name on the line.

boy

boil

toys

soil

1.  _____

2.  _____

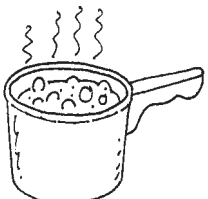
3.  _____

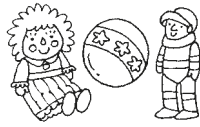
4.  _____

B. Read the words. Circle the two letters that stand for the sound at the end of boy.

broil

joy

toil

noise

toys

coy

Name _____

**A. Circle the word that completes each sentence.
Then write the word on the line.**

1. I use my _____ to see.
eyes nose

2. Did you _____ the box yet?
fall open

3. I have had _____ to eat.
enough work

4. She will take _____ the kids with her.
all done

Name _____

Sequence is what happens first, next, and last in a story.

As you read “Joy’s Surprise,” fill in the Sequence Chart.

First
↓
Next
↓
Last

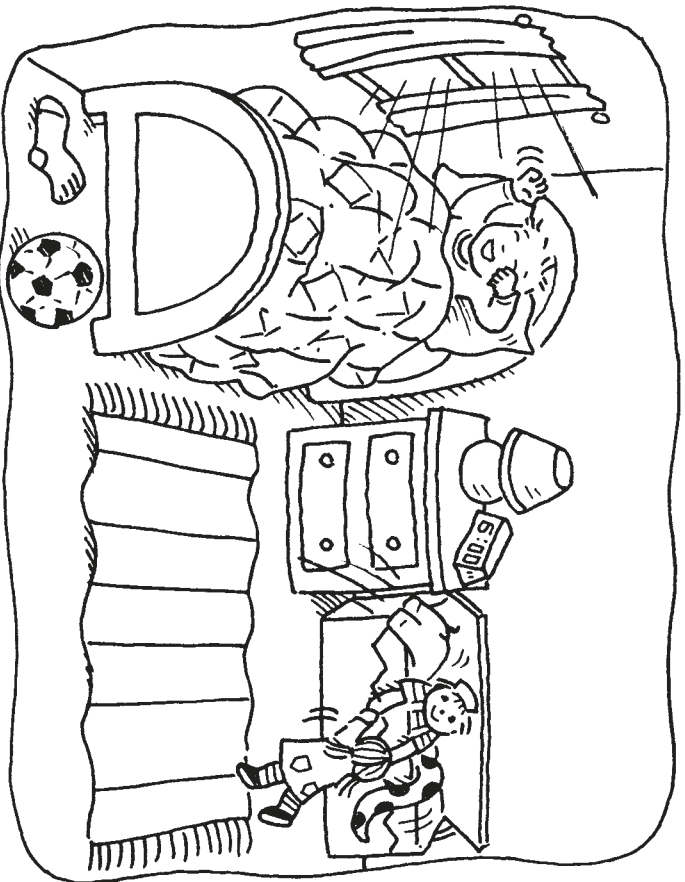

Then Roy's toys got back in the toy chest. Roy would get up soon. But it was time for the toys to go to sleep!

Roy's Toys

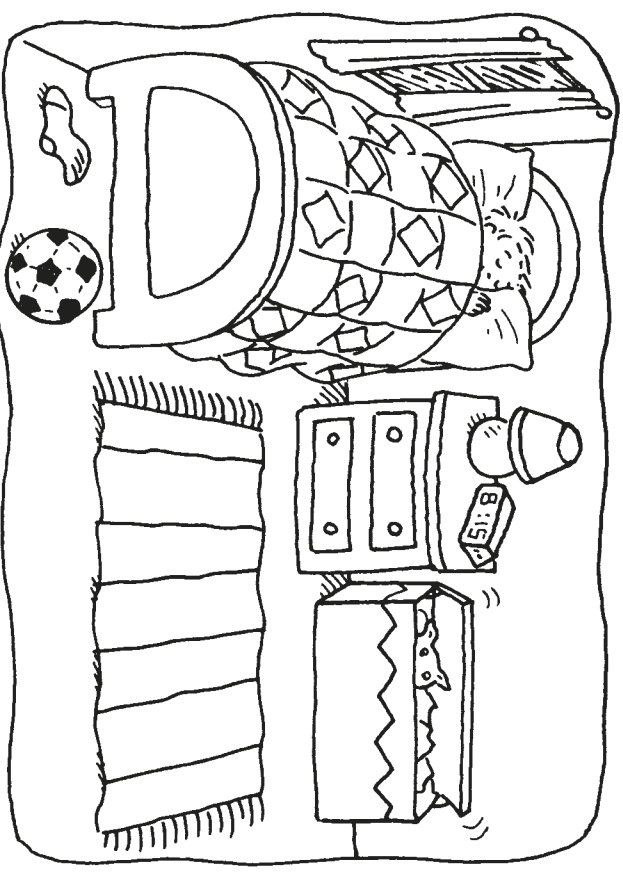

Roy went to bed just like every night. But when he closed his eyes, there was a noise. His toy chest started to open!

High-Frequency Words:
Circle the words eyes and open in the story.



At Home: Ask your child to read the book aloud to you.

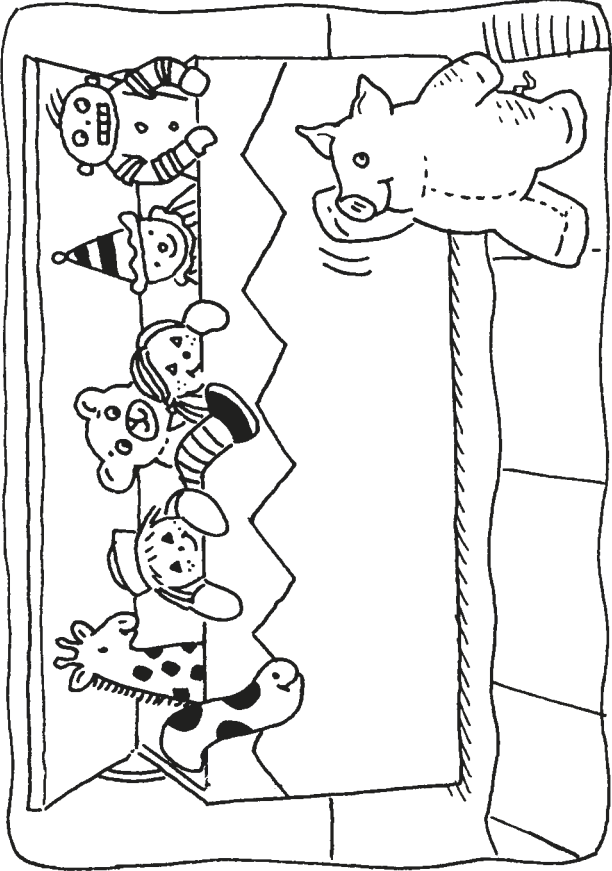

Roy's toy pig peeked out of the chest. It jumped down without making a noise. The other toys joined Pig. It was time for them to play!

Phonics: Draw a line under words with **oy** and **oi**.

2

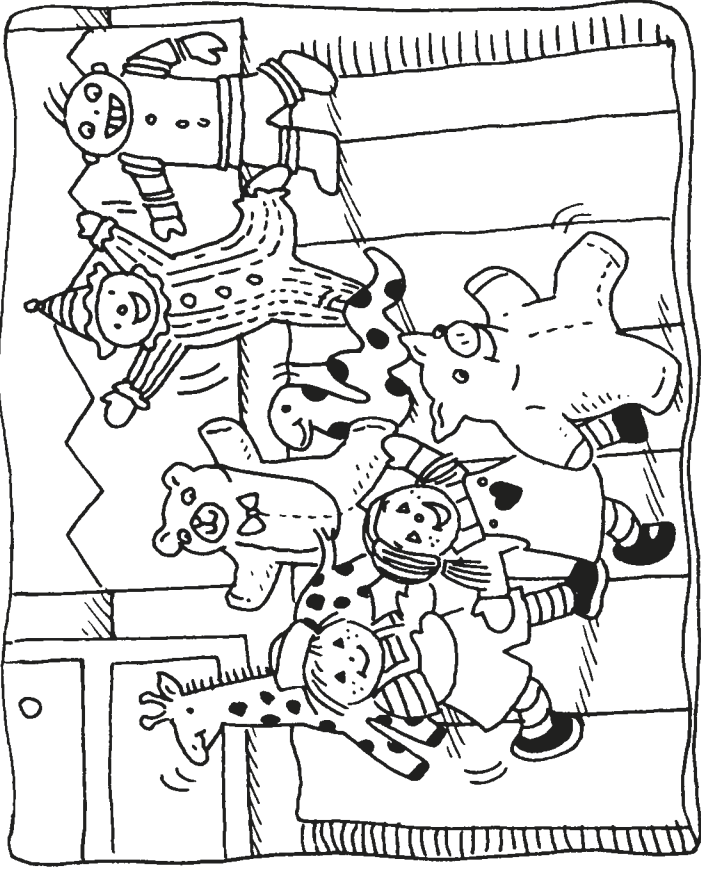











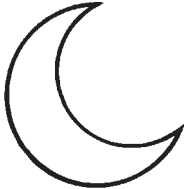

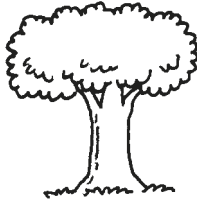

The toys skipped and jumped. Then they marched and sang a tune. "This is fun!" cried the boy and girl dolls.

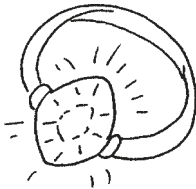
Comprehension: What happened after the pig jumped out of the chest?

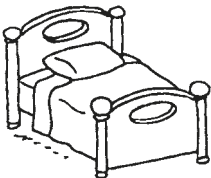
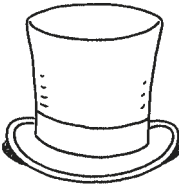
3

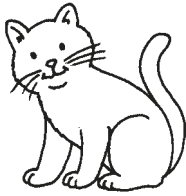
Name _____

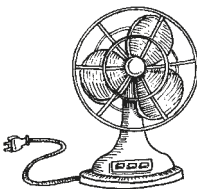
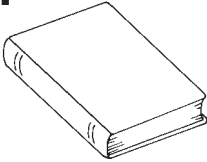
Say the name of each picture. Circle the picture whose name has the same vowel sound as the first picture.

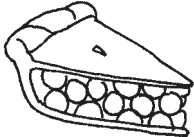
1. 			
2. 			
3. 			
4. 			
5. 			

Name _____



book

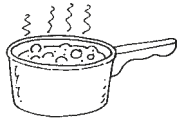





soup

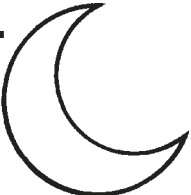
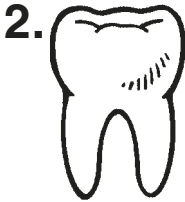

drew

Circle the word that names each picture. Then write the word on the line.

<p>1.  moon mat mouse</p> <p>_____</p> <p>_____</p> <p>_____</p>	<p>2.  tube rat tooth</p> <p>_____</p> <p>_____</p> <p>_____</p>	<p>3.  book foot fool</p> <p>_____</p> <p>_____</p> <p>_____</p>
<p>4.  bite blew bat</p> <p>_____</p> <p>_____</p> <p>_____</p>	<p>5.  growl get group</p> <p>_____</p> <p>_____</p> <p>_____</p>	<p>6.  broom boot bunch</p> <p>_____</p> <p>_____</p> <p>_____</p>

Name _____

A. Read the words in the box. Write one word on each line.

love

pretty

sure

eight

1. _____

2. _____

3. _____

4. _____

B. Use a word from the box to finish each sentence. Write the word on the line.

1. Did the hen lay _____ eggs?

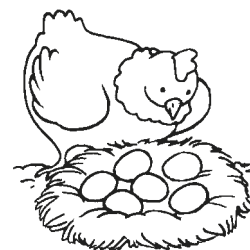

2. That is such a _____ dress!

3. Are you _____ you do not want to come with us?

4. I _____ to go to the park.

Name _____

A **fantasy** is a story that could not happen in real life.

As you read “Toys at Night,” fill in the Reality and Fantasy Chart.

Reality	Fantasy
What Could Happen?	What Could Not Happen?

Three Billy Goats

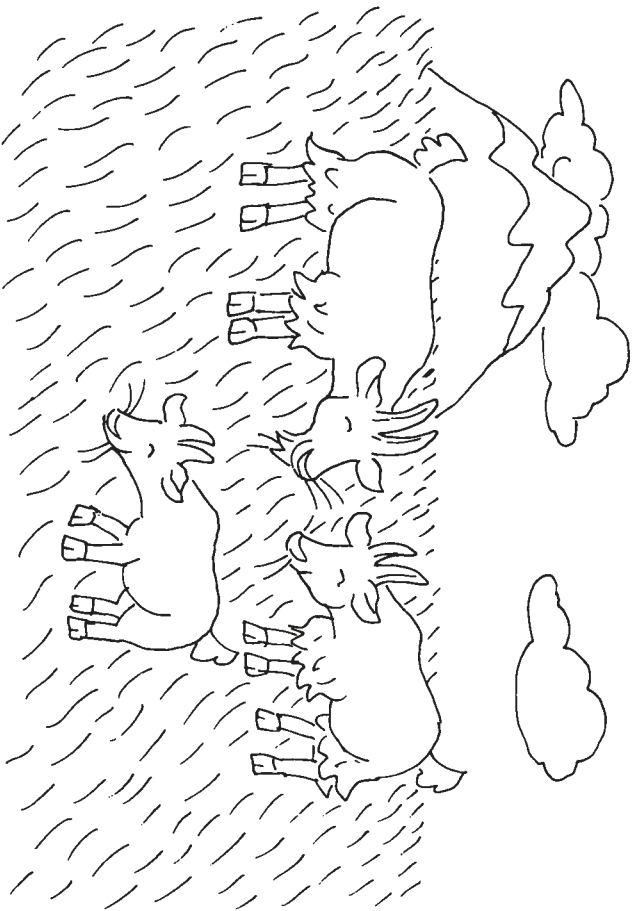

“Me too!” cried Bigger Billy.

“Let’s chew,” added Little Billy.

“Good,” said Biggest Billy.

Chew! Chomp! Chew!

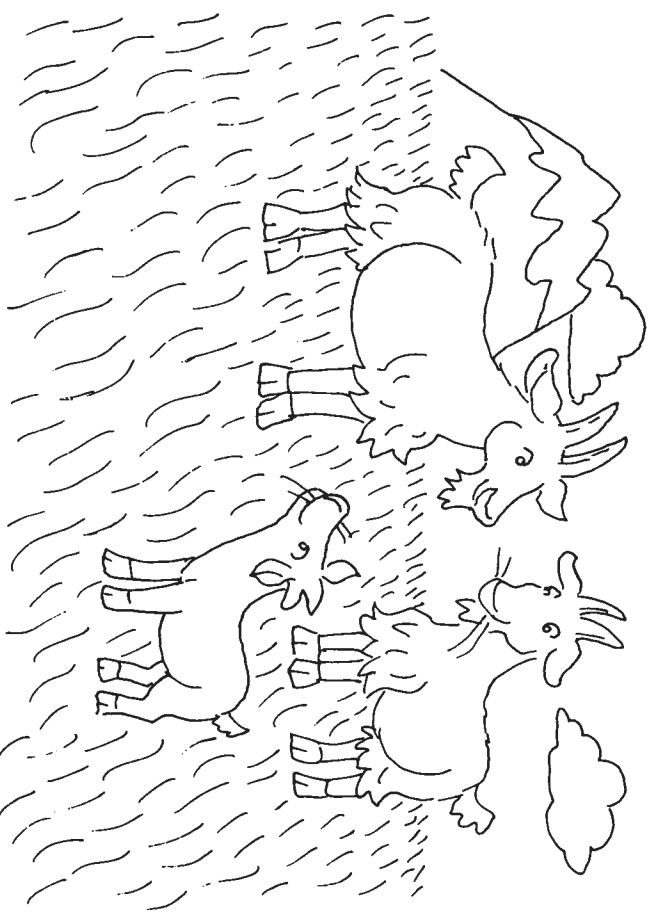

Three Billy Goats chewed
grass all day.

“We love food too much,”
said Little Billy. “We need
to run and jump, too.”





“Good thinking,” said
Bigger Billy.
They got some wood. They
each took a turn jumping.

Phonics: Underline the words with oo that
have the same vowel sound as food.

2

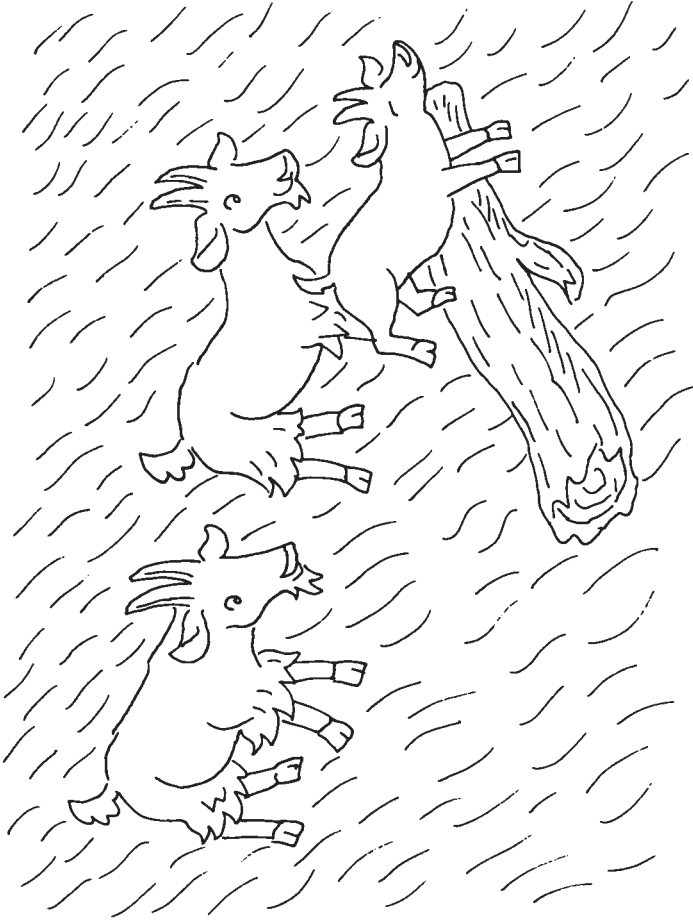











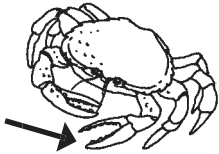

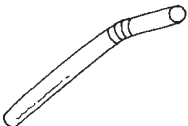

“That was sure fun,” said
Little Billy.
“Now I am in the mood for
food,” said Biggest Billy.

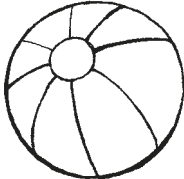
Comprehension: Could this story really
happen? Why or why not?

3

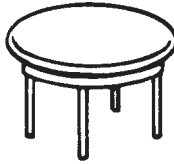
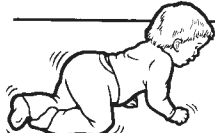
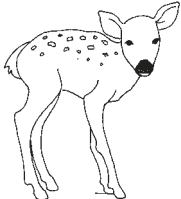



Name _____

Say the name of each picture. Circle the picture whose name has the same vowel sound as the first picture.

<p>1.</p> 			
<p>2.</p> 			
<p>3.</p> 			
<p>4.</p> 			

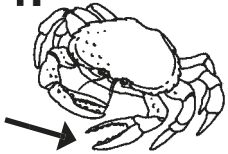
Name _____

Look at each picture. Use the letter tiles to complete each picture name.

<div style="border: 1px solid black; border-radius: 10px; padding: 5px; text-align: center; width: 40px; margin: 5px;">a</div> <div style="border: 1px solid black; border-radius: 10px; padding: 5px; text-align: center; width: 40px; margin: 5px;">w</div> <div style="border: 1px solid black; border-radius: 10px; padding: 5px; text-align: center; width: 40px; margin: 5px;">u</div>	<p>1.</p> 	c	l			
	<p>2.</p> 	h			l	
<div style="border: 1px solid black; border-radius: 10px; padding: 5px; text-align: center; width: 40px; margin: 5px;">a</div> <div style="border: 1px solid black; border-radius: 10px; padding: 5px; text-align: center; width: 40px; margin: 5px;">w</div> <div style="border: 1px solid black; border-radius: 10px; padding: 5px; text-align: center; width: 40px; margin: 5px;">l</div>	<p>3.</p> 	p				
	<p>4.</p> 	w			k	
	<p>5.</p> 	y			n	

Name _____

A. Read the words in the box. Write one word on each line.

four

nothing

carry

over

1. _____

2. _____

3. _____

4. _____

B. Use a word from the box to finish each sentence.

1. He draws _____ things.



2. Will you _____ the bag for me?

3. There is _____ in the box.

4. The cat can jump _____ the dog.

Name _____

An **inference** is a guess you make based on the story clues the author gives you.

As you read “Paws and Claws,” fill in the Inference Chart.

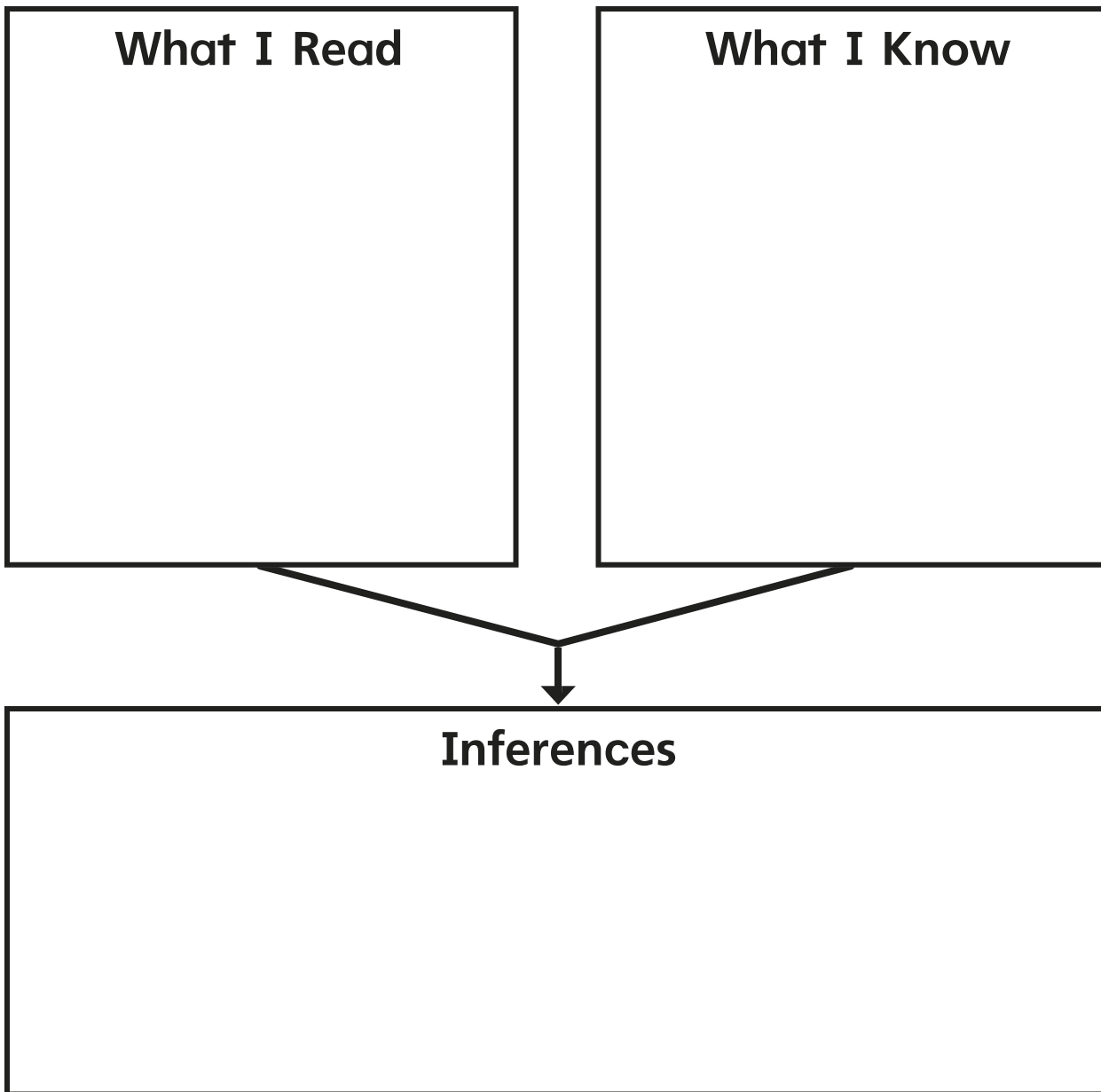

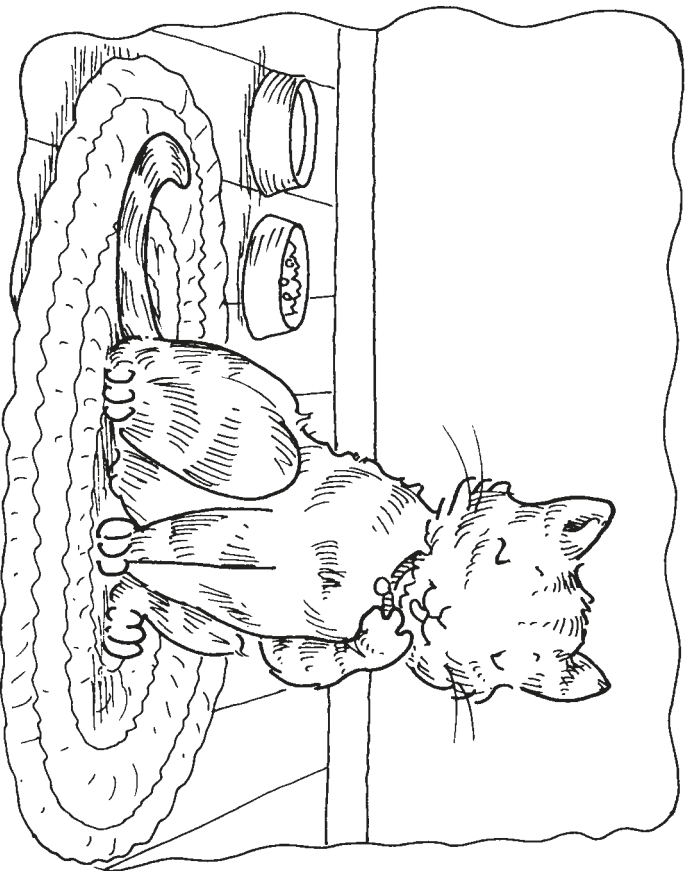

A cat is a very clean
animal. It will wash its
paws after it eats its food.
A cat likes to have clean
paws and sharp claws.

A Cat's Claws

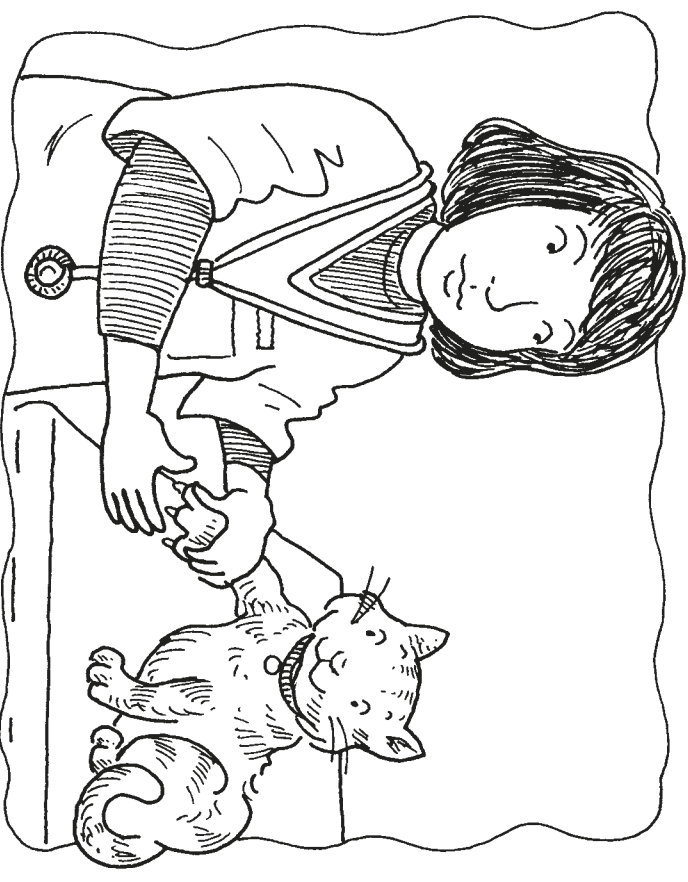

A cat has four paws.
Each paw has claws.
A cat uses its claws for
many things.





A cat's claws are sharp.
A cat needs its sharp claws
to go up a big tree trunk.
Claws help a cat when it
goes down the tree, too.

Phonics: Draw a line under words
with *aw*.

2

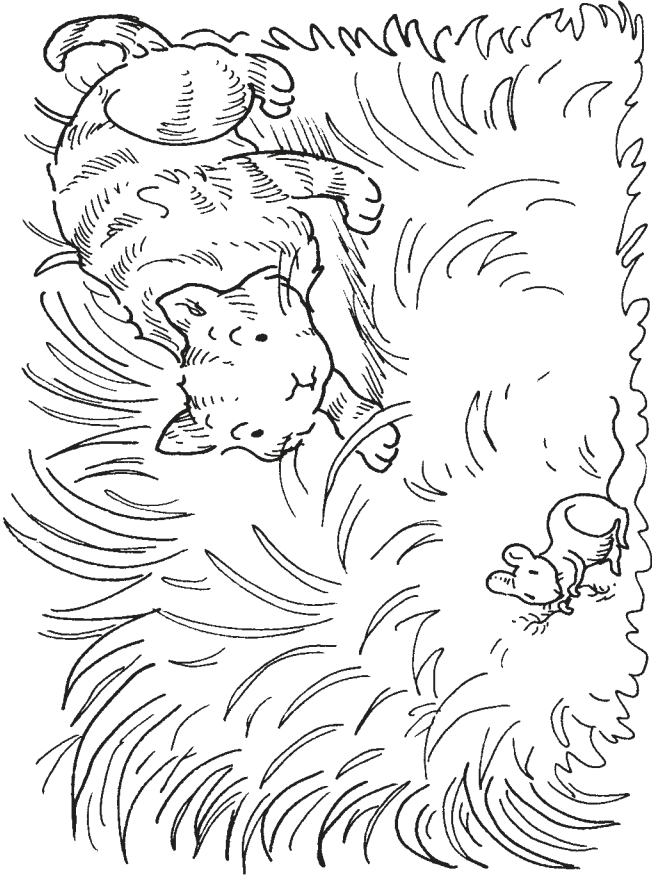

This cat is hunting.
It crawls in the grass to get
something good to eat.
The cat's claws will help it
catch and carry food.

Comprehension: Why is the cat looking
at the mouse?

3

Name _____

Say the name of each picture. Write the number 1, 2, or 3 to show the number of syllables in the picture name.

1.

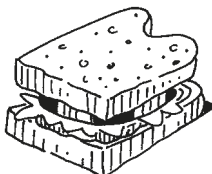

2.

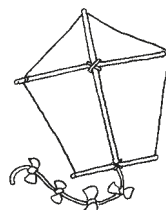

3.

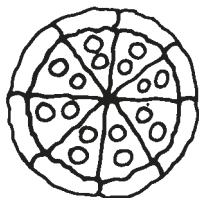

4.



5.



6.

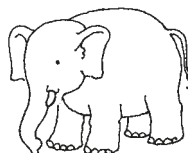

7.



8.

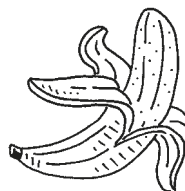

9.

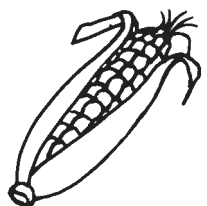

10.

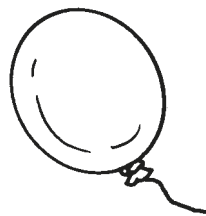

Name _____







ba/by
Open Syllable

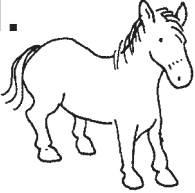
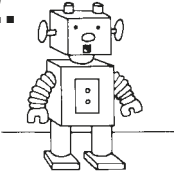
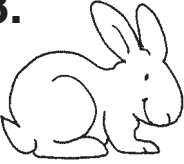

sun/ny
Closed Syllable

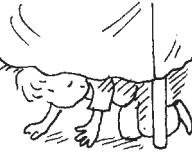
Read the words. Write O if the first syllable is open.
Write C if the first syllable is closed. Then underline
the letters that make the open or closed syllable.

<p>1.  po/ny</p> <p>_____</p> <p>_____</p> <p>_____</p>	<p>2.  ro/bot</p> <p>_____</p> <p>_____</p> <p>_____</p>	<p>3.  rab/bit</p> <p>_____</p> <p>_____</p> <p>_____</p>
<p>4.  den/tist</p> <p>_____</p> <p>_____</p> <p>_____</p>	<p>5.  un/der</p> <p>_____</p> <p>_____</p> <p>_____</p>	<p>6.  spi/der</p> <p>_____</p> <p>_____</p> <p>_____</p>

Name _____

A. Read the words in the box. Write one word on each line.

call

only

full

one

1. _____

2. _____

3. _____

4. _____

B. Use a word from the box to finish each sentence.

1. There is a _____ moon in the sky.



2. There is _____ very bright star.

3. Let's _____ Grandma to tell her.

4. Grandma _____ lives two blocks away.

Name _____

When you put things that are alike into the same group, you are **classifying** and **categorizing**.

As you read “The Seasons,” fill in the Classify and Categorize Chart.

Season	Activities

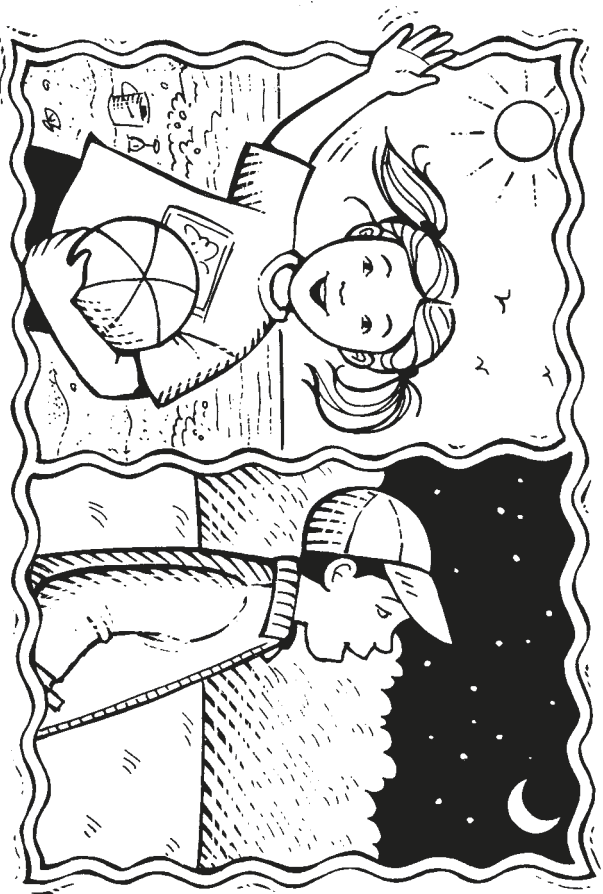

Sometimes the moon is full and round. Sometimes it appears to be oval.

Sometimes you can only see a sliver. There is so much to look at in the sky.

High-Frequency Words:
Circle the words one and full in the story.



At Home: Ask your child to read the book aloud to you.

The Sun and the Moon

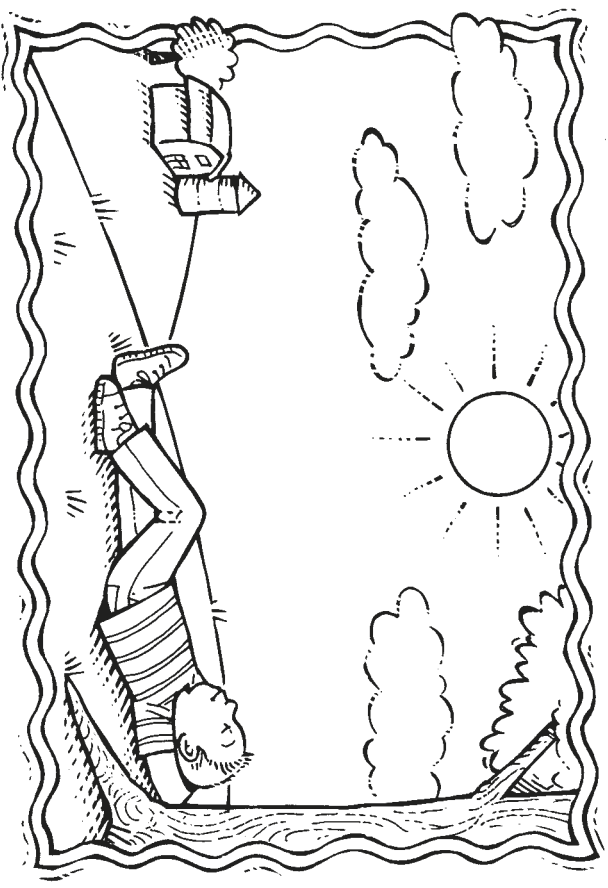

Our planet has one sun. We can see our sun in the day. It looks big and round and yellow.

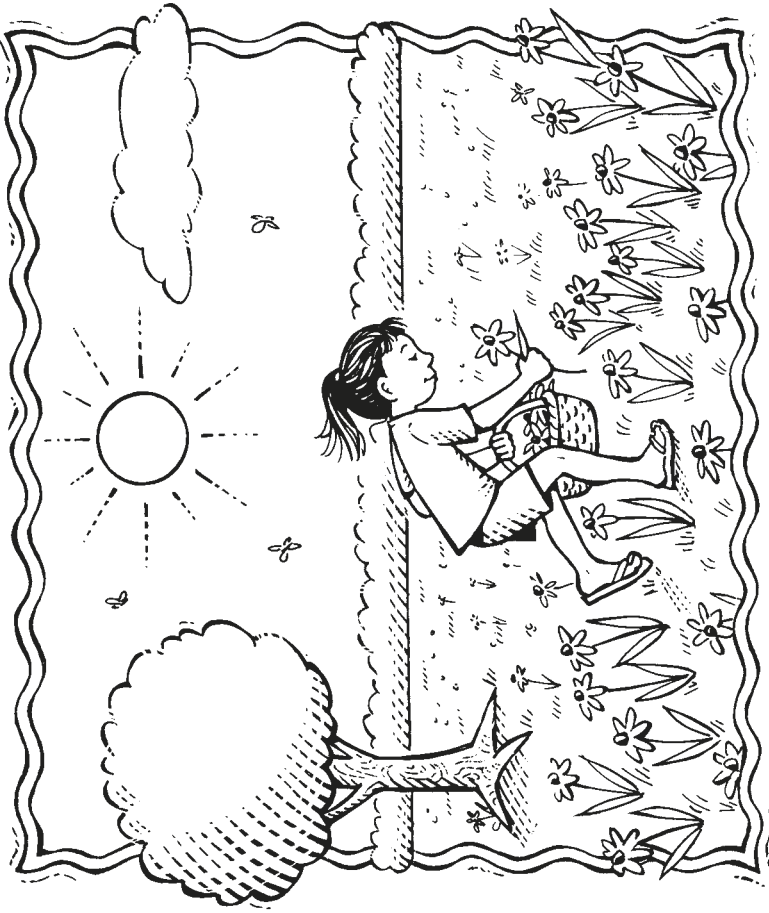

The sun helps us in many ways. It brings us light and warmth. It helps plants grow and blossom.

Phonics: Draw a line under two words that have a closed syllable.

2



Our planet has one moon. We can see the moon at night. What does the moon look like? That depends on when you happen to be looking.

Comprehension: What can you see in the sky during the day? What can you see at night?

3

Name _____

Say the name of each picture. Listen for the short vowel sound in the first syllable. Match the letter sound to the picture.

a

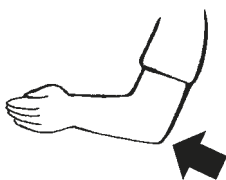

e

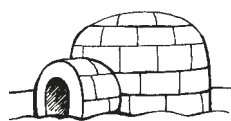

i



Say the name of each picture. Listen for the long vowel sound in the first syllable. Match the letter sound to the picture.

e

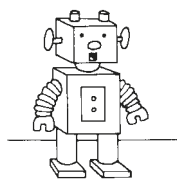

i

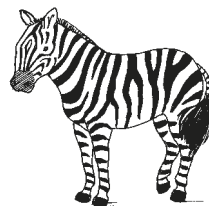

o



Name _____



li/on





Open Syllable

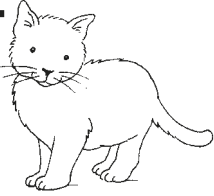

pan/da

Closed Syllable

Read the words. Write O if the first syllable is open.
Write C if the first syllable is closed. Then underline
the letters that make the open or closed syllable.

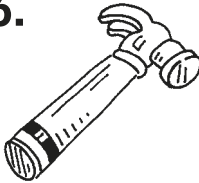
<p>1.  kit/ten</p> <p>_____</p> <p>_____</p> <p>_____</p>	<p>2.  co/bra</p> <p>_____</p> <p>_____</p> <p>_____</p>	<p>3.  mu/sic</p> <p>_____</p> <p>_____</p> <p>_____</p>
<p>4.  bun/ny</p> <p>_____</p> <p>_____</p> <p>_____</p>	<p>5.  spi/der</p> <p>_____</p> <p>_____</p> <p>_____</p>	<p>6.  ham/mer</p> <p>_____</p> <p>_____</p> <p>_____</p>

Name _____

A. Read the words in the box. Write one word on each line.

down

after

before

been

1. _____

2. _____

3. _____

4. _____

B. Use a word from the box to finish each sentence.

1. We will dry the dog _____ his bath.



2. I brush my teeth _____ I go to bed.

3. Have you _____ to the park?

4. May I sit _____ here?

Name _____

To **predict** means to make a good guess about what you think will happen next in a story.

As you read “Let’s Plant Seeds,” fill in the Predictions Chart.

What I Predict	What Happens



“We love you, Gram,” say Jennifer and Jason.

“What a splendid surprise!” says Gram.

Surprise for Gram

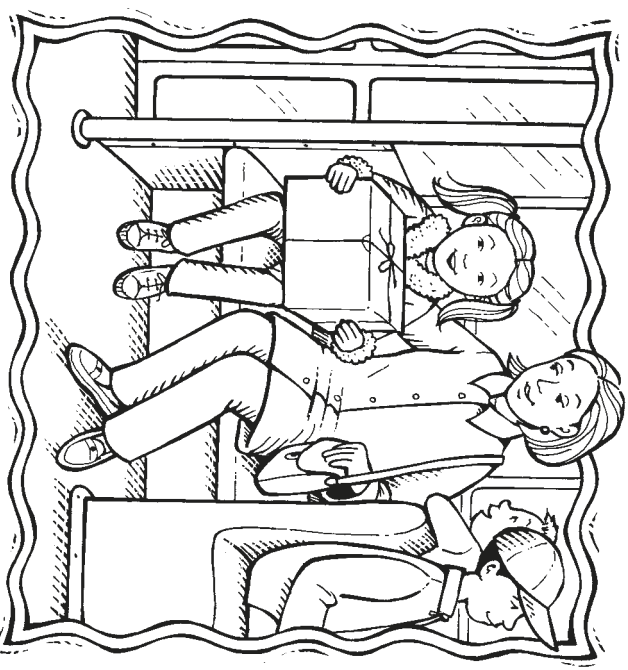

It is Gram’s birthday. The children are planning a surprise. They have been preparing all week. Jennifer and Mom baked a cake for the event.

High-Frequency Words:

Circle the words been,
before, and after in the
story.



At Home: Ask your child to read the book aloud to you.

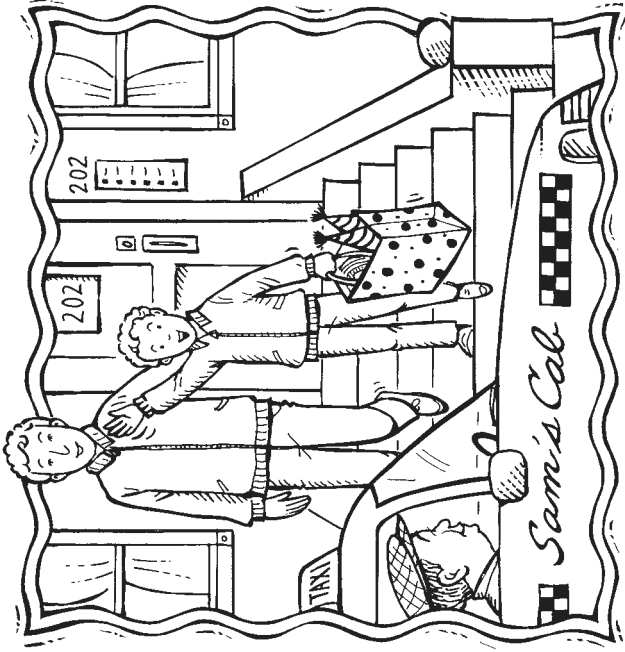

Jason and Dad bring the party favors. They take a cab to Gram's. Then they will meet Jennifer and Mom. Before they go in, they finish making plans.

Phonics: Draw a line under two words that have an open syllable.

2

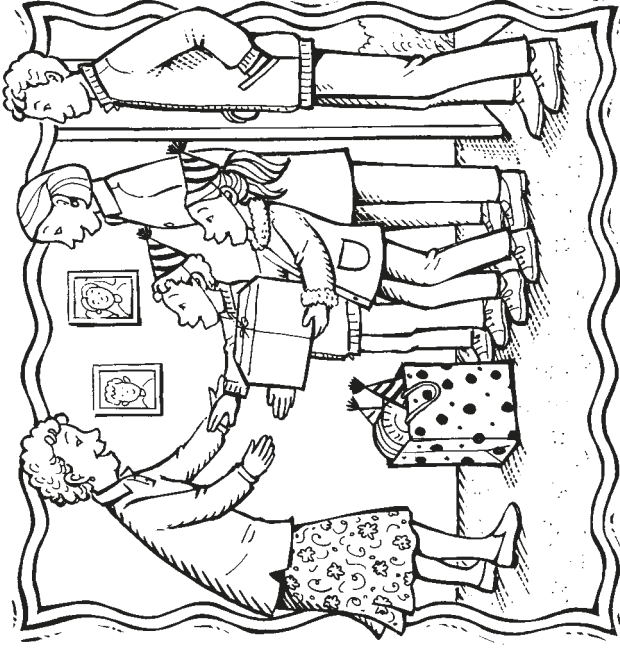













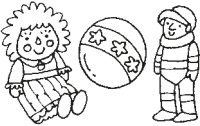

The children decide to put on hats. After Gram opens the door, they give her gifts. “I did not expect this!” says Gram.

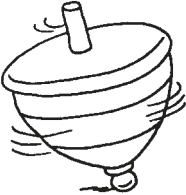
Comprehension: How did you think the children would surprise Gram?

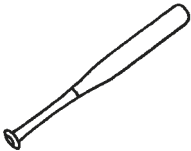
3

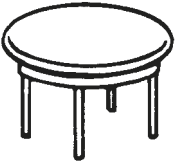
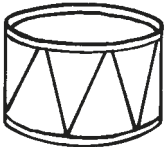
Name _____

Say the name of each picture. Circle the picture in each row whose name ends in the sound /əl/.

1.				
2.				
3.				
4.				

Name _____



Look at each picture. Write the picture name on the line. Draw a line between the two syllables. Then underline the letters that make the final stable syllable.

turtle table juggle circle beetle candle

1.  _____
tur/le

2.  _____

3.  _____

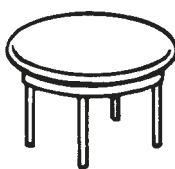
4.  _____

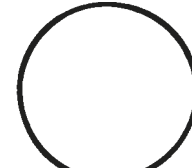
5.  _____

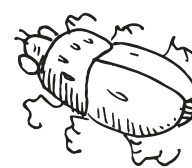
6.  _____

Name _____

A. Read the words in the box. Write one word on each line.

their

always

around

laugh

1. _____

2. _____

3. _____

4. _____

B. Use a word from the box to finish each sentence.

1. My pals love to walk _____ dogs.

2. I _____ at Mom's joke.

3. It is _____ fun to go to music class.

4. We run _____ the track two times.

Name _____

The **characters** are the people or animals in the story.
The **setting** is where the story takes place.

As you read “Three Billy Goats,” fill in the Character and Setting Chart.

Setting	What the Characters Do There

Pancake Puzzle



When Gwen woke up she smelled pancakes. She smiled. Dad always made pancakes when something good was about to happen!

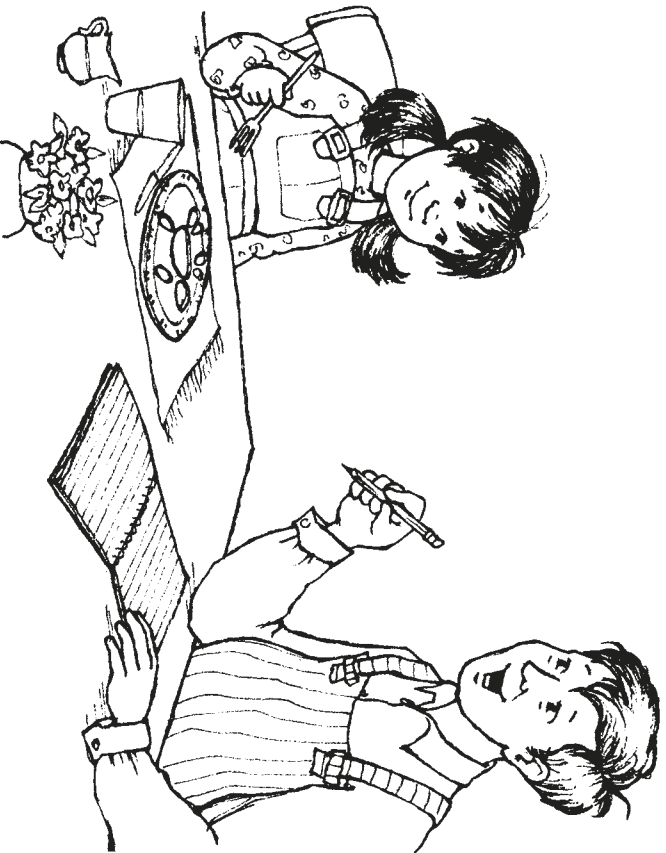

Then she gave a little laugh.
“Are we getting a dog?” she asked.
“Yes,” said Dad. “Maybe we can call it Pancake.”



At Home: Ask your child to read the book aloud to you.

High-Frequency Words:
Circle the words always
and laugh in the story.

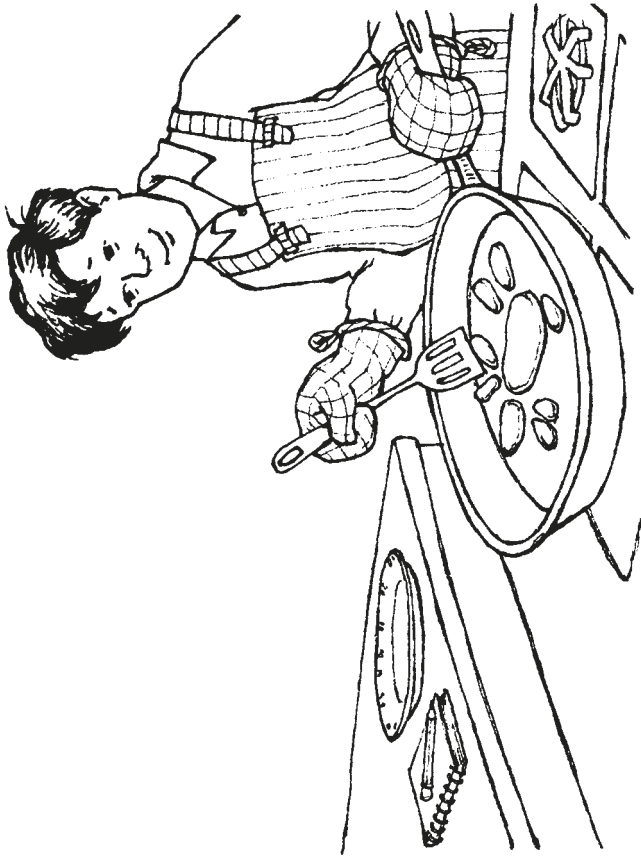

“What’s up, Dad?” asked Gwen.

“Something little is coming,” said Dad with a giggle.

“Something you can cuddle.”

Phonics: Underline all words that have a final syllable with **-le**.



Then Dad put lots of small pieces of pancake on Gwen’s plate. Gwen looked at it. It was like a puzzle.

Comprehension: How do you think Gwen feels when she realizes it’s a dog?