

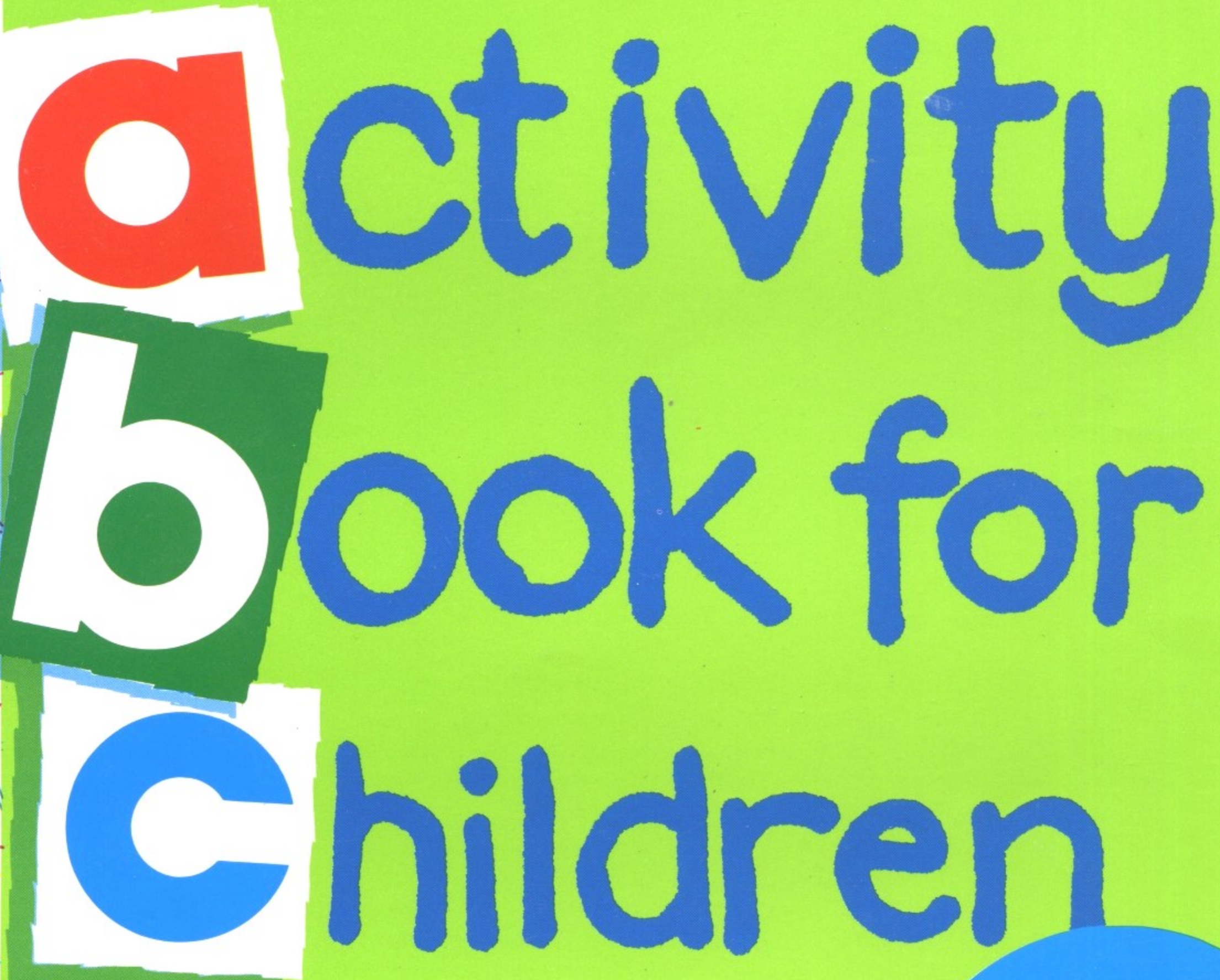

Christopher Clark



activity
book for
children



Oxford University Press
Walton Street, Oxford OX2 6DP

Oxford New York Toronto
Delhi Bombay Calcutta Madras Karachi
Petaling Jaya Singapore Hong Kong Tokyo
Nairobi Dar es Salaam Cape Town
Melbourne Auckland

and associated companies in
Berlin Ibadan

Oxford English and the *Oxford English logo* are trade marks
of Oxford University Press

ISBN 0 19 421832 5

© Oxford University Press 1983

First published 1983
Seventh impression 1989

All rights reserved. No part of this publication may
be reproduced, stored in a retrieval system, or
transmitted, in any form or by any means, electronic,
mechanical, photocopying, recording, or otherwise,
without the prior permission of Oxford University Press

This book is sold subject to the condition that it shall
not, by way of trade or otherwise, be lent, re-sold,
hired out or otherwise circulated without the publisher's
prior consent in any form of binding or cover other
than that in which it is published and without a
similar condition including this condition being
imposed on the subsequent purchaser

Printed in Hong Kong

Activity Book for Children

3

Christopher Clark

Illustrated by Terry Burton

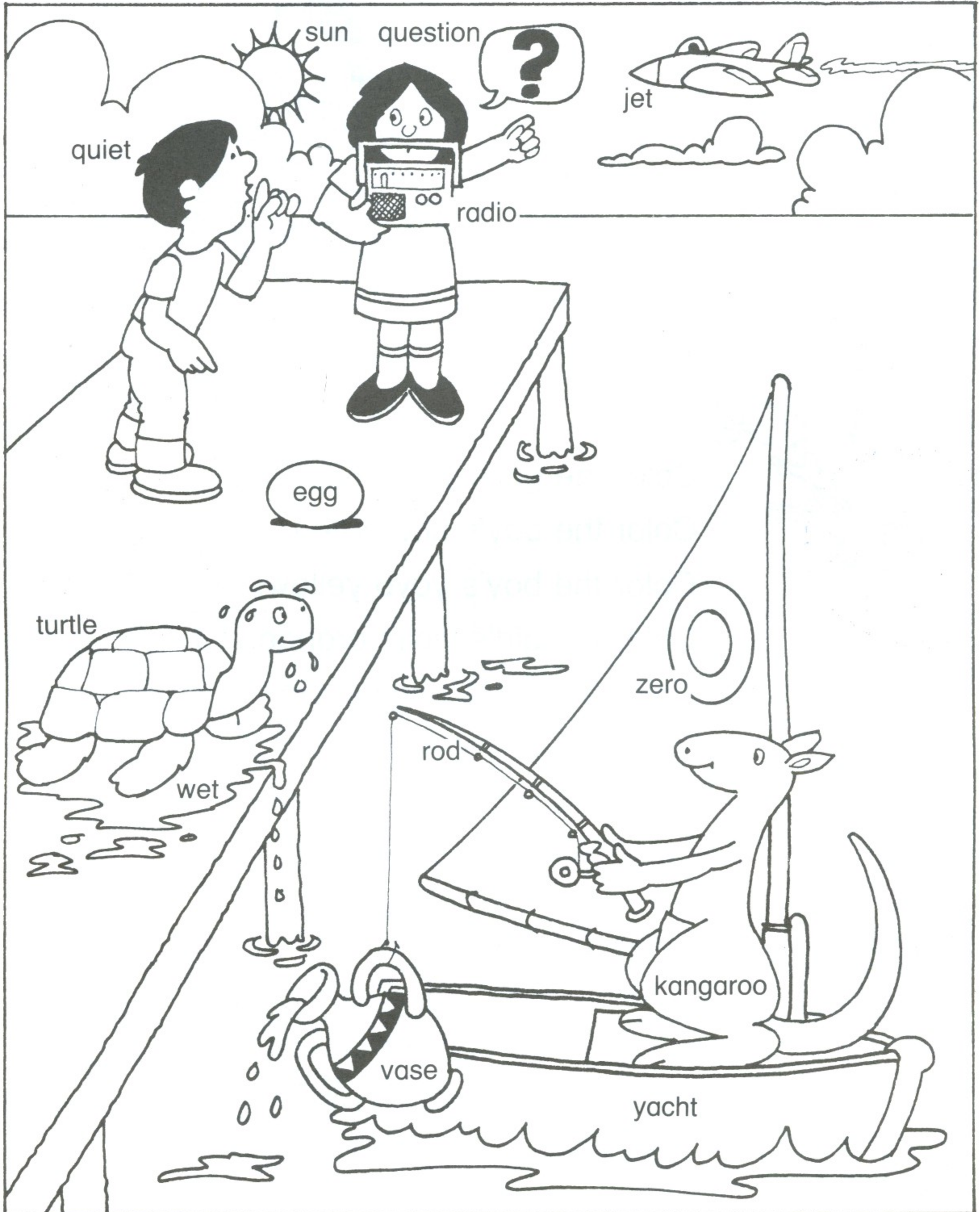



yoyo

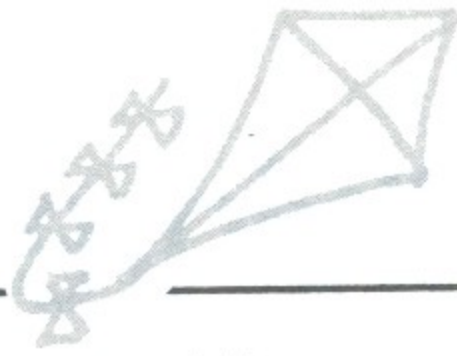

kite

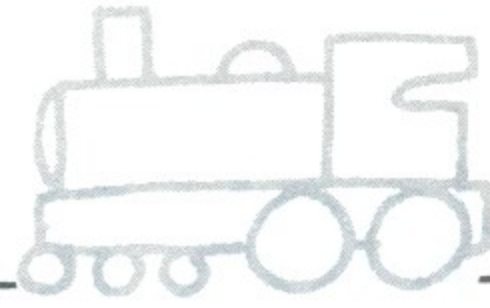

engine

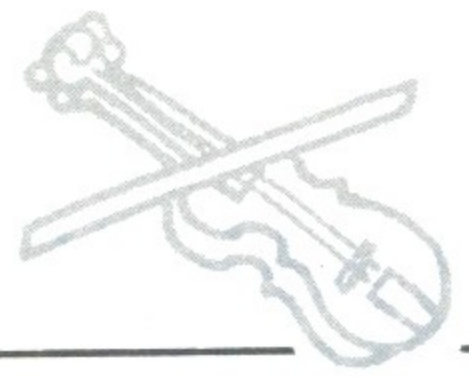

violin

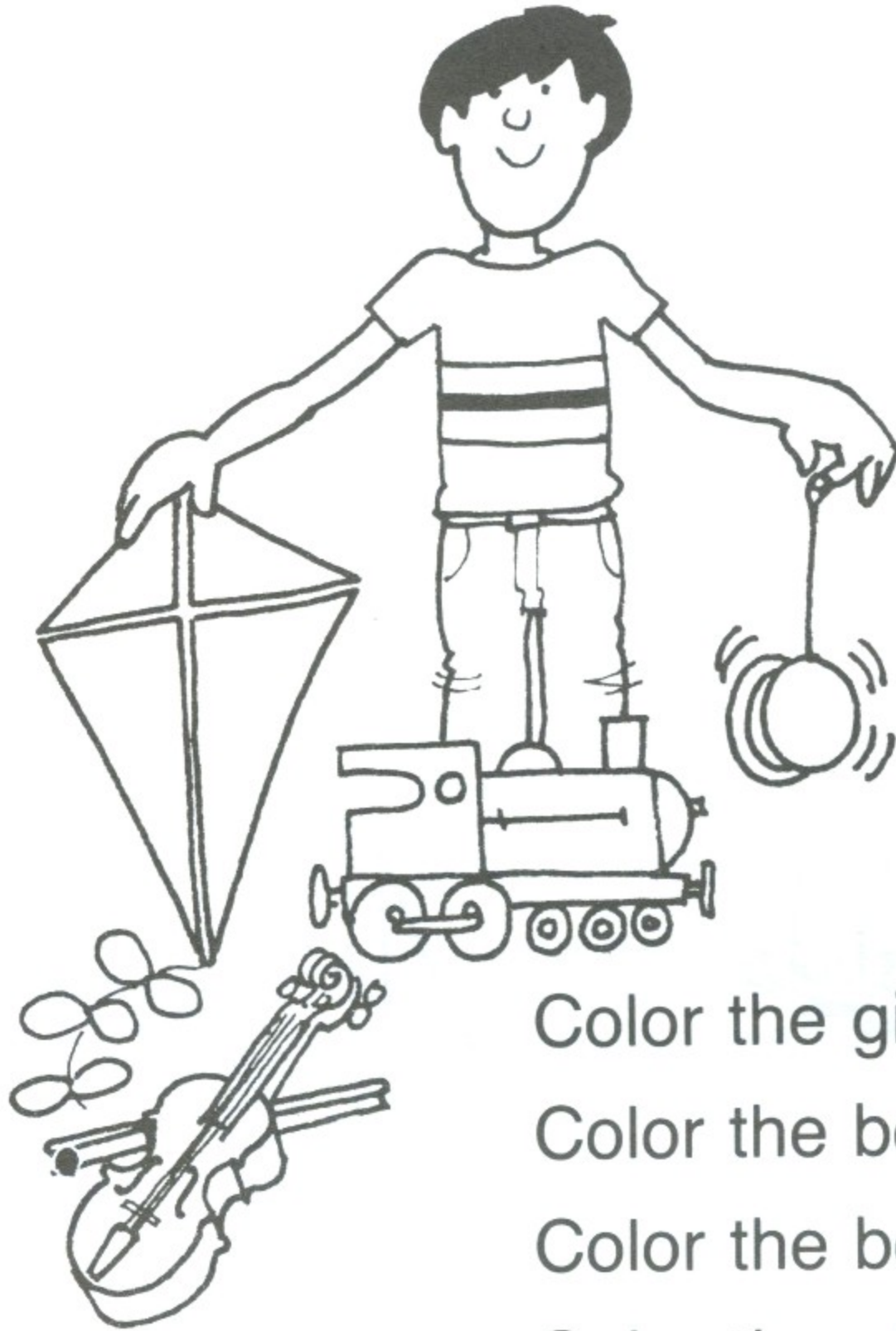

- Color the girl's yoyo pink.
- Color the boy's kite green.
- Color the boy's yoyo yellow.
- Color the girl's violin orange.
- Color the boy's engine red.
- Color the boy's violin blue.
- Color the girl's engine yellow.
- Color the girl's kite green.



c c c

c g c g



g g g



c

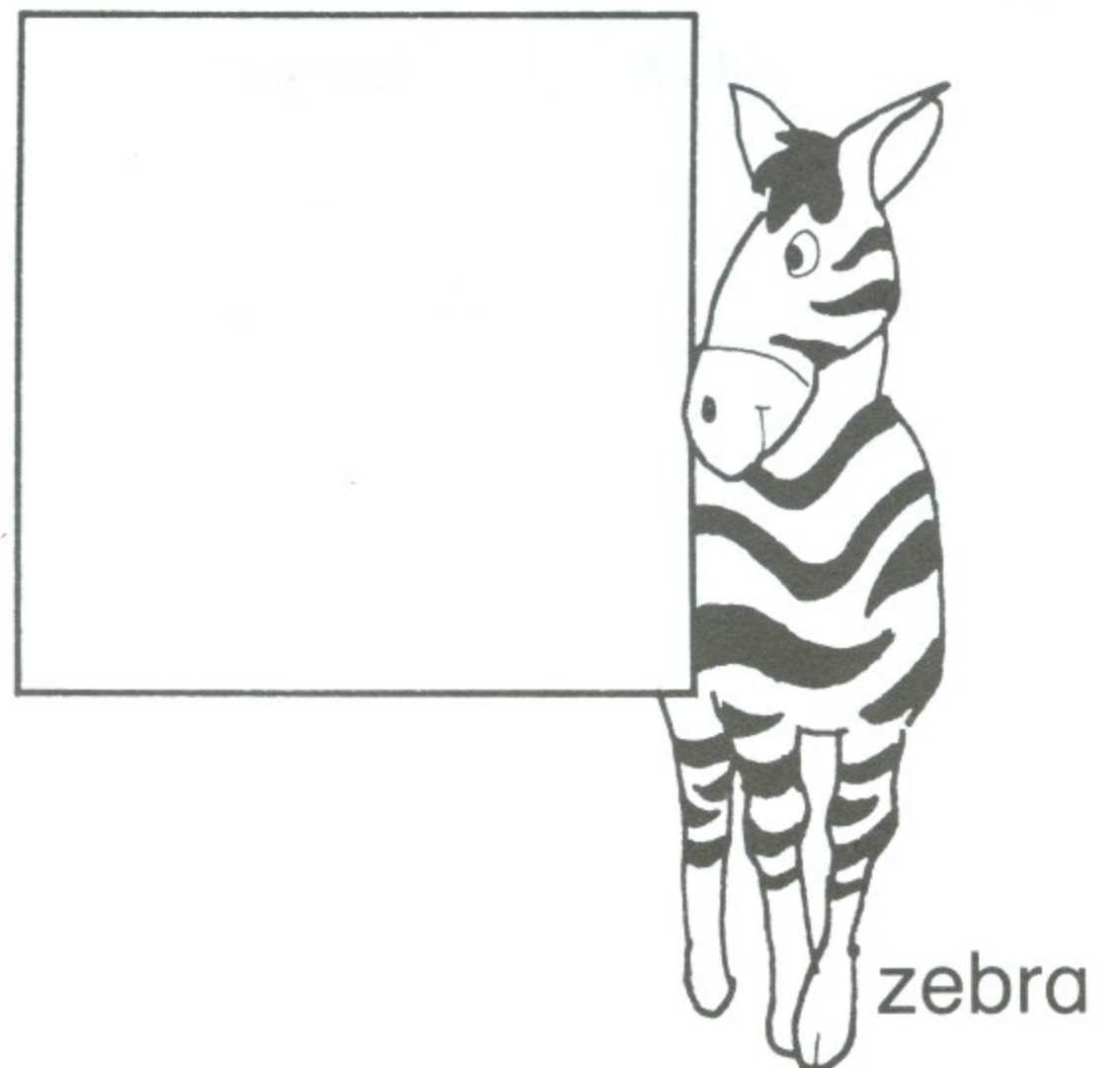
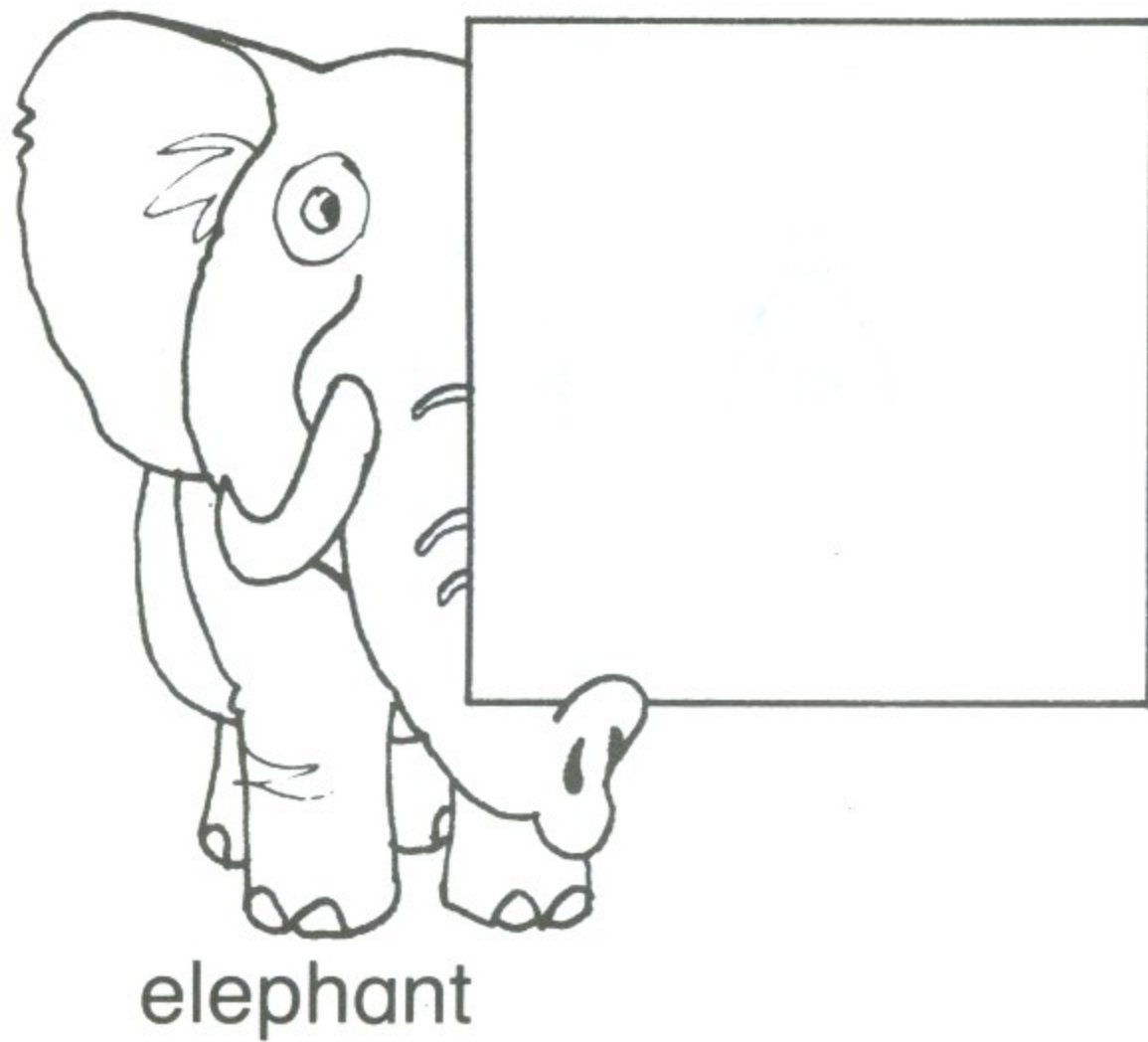
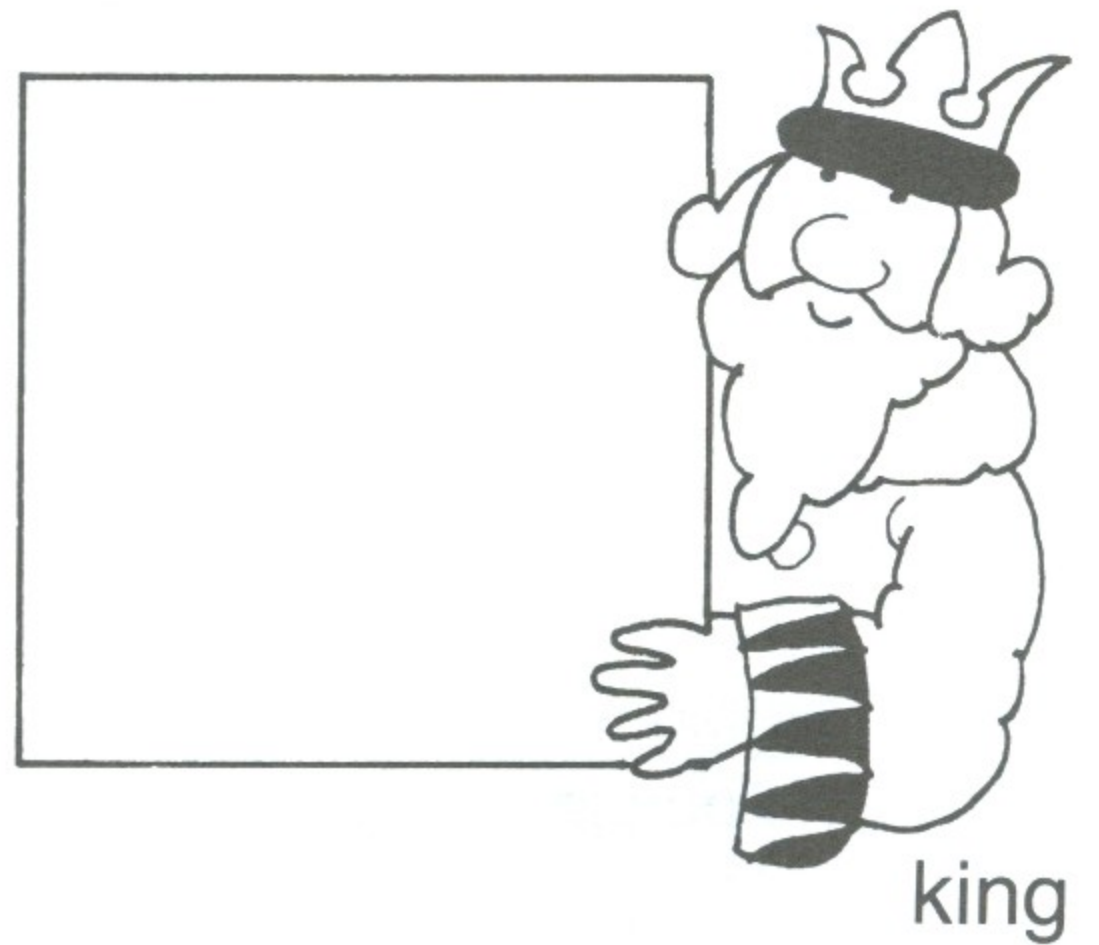
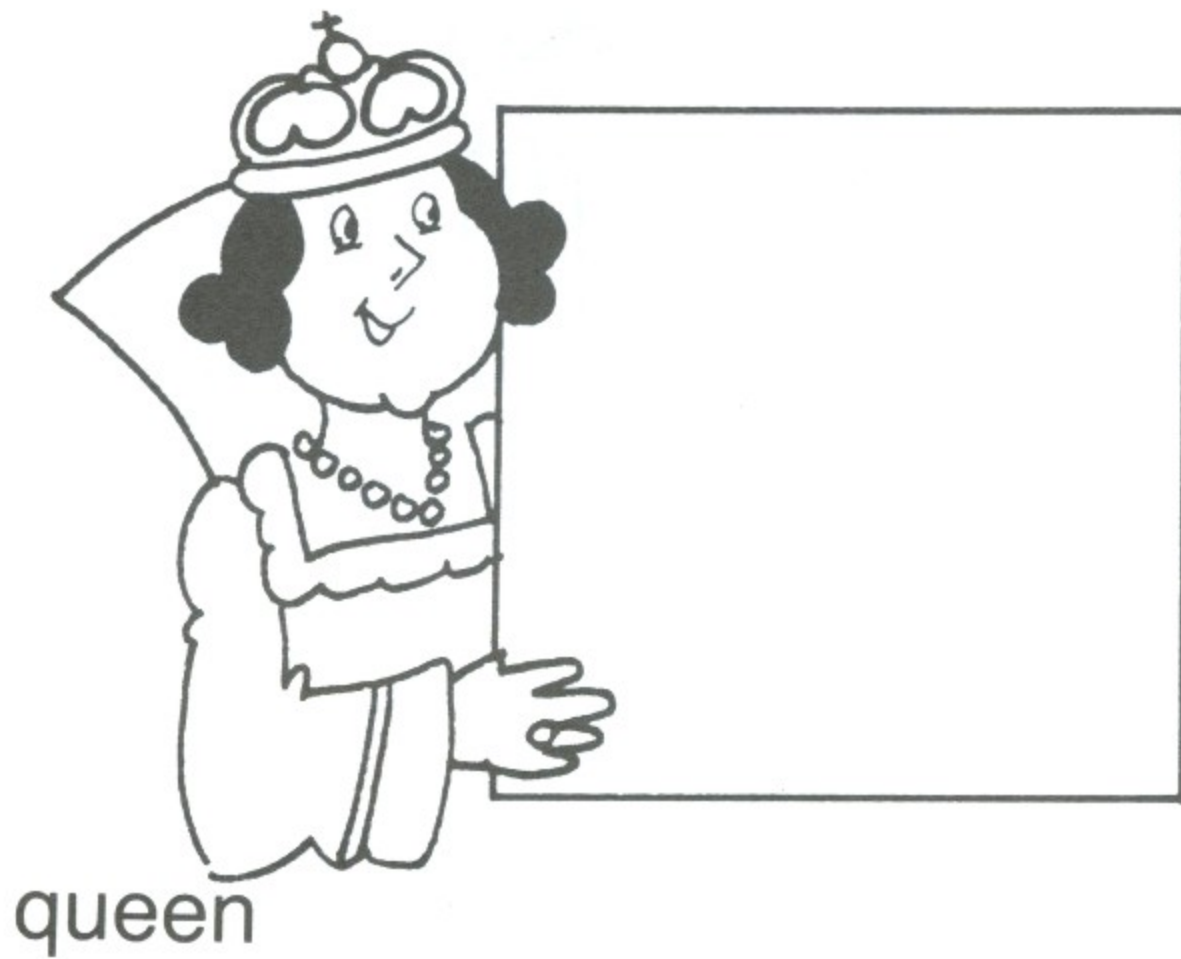
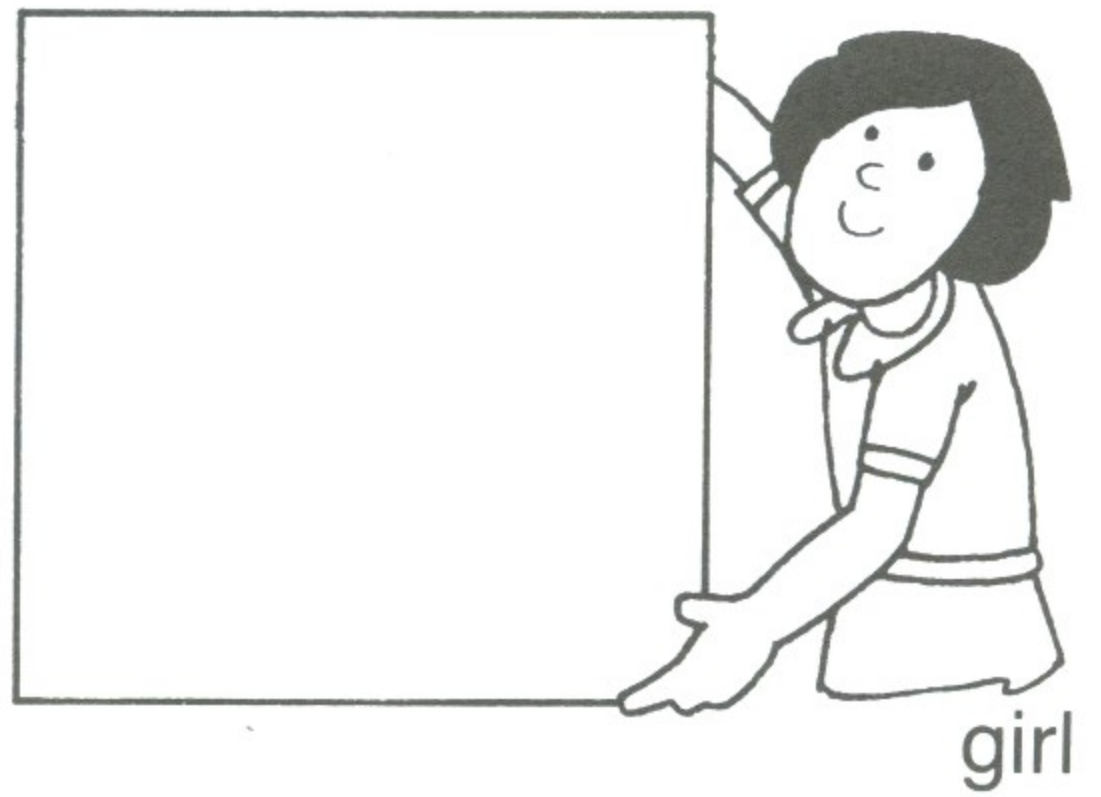
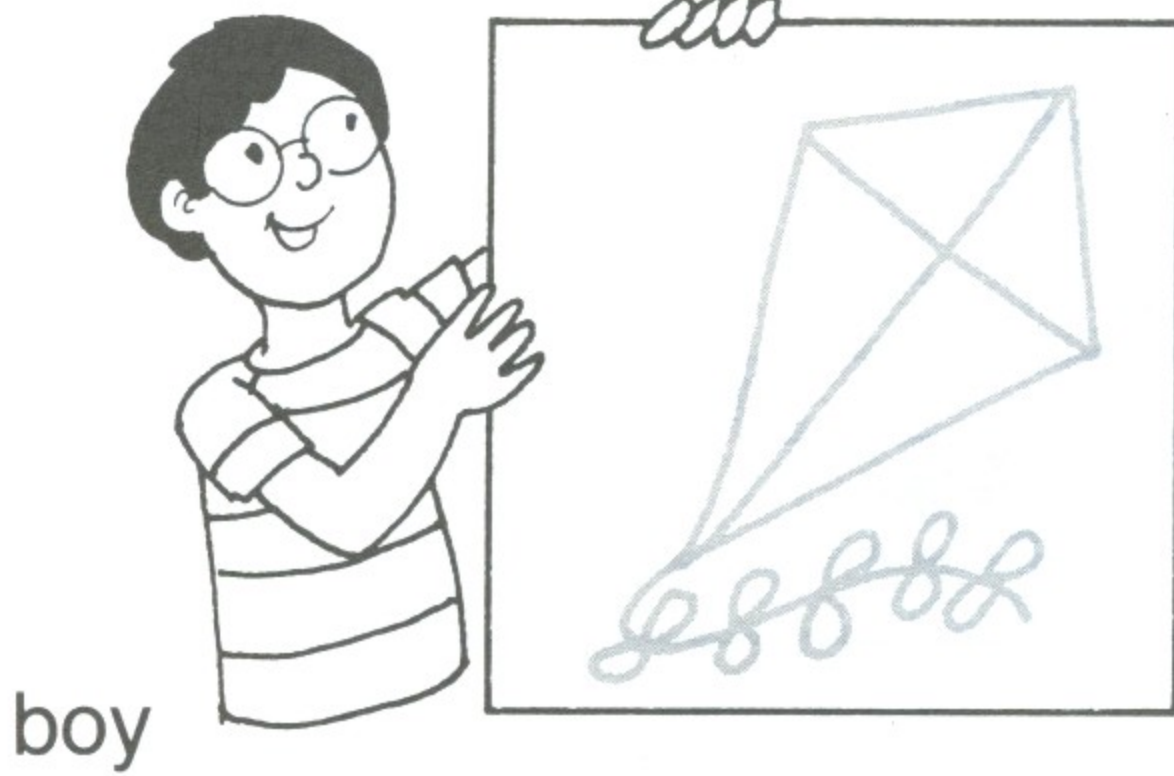

1. Draw a kite in the boy's box.
2. Draw a violin in the queen's box.
3. Draw a violin in the zebra's box.
4. Draw a kite in the king's box.
5. Draw a kite in the girl's box.
6. Draw a violin in the elephant's box.

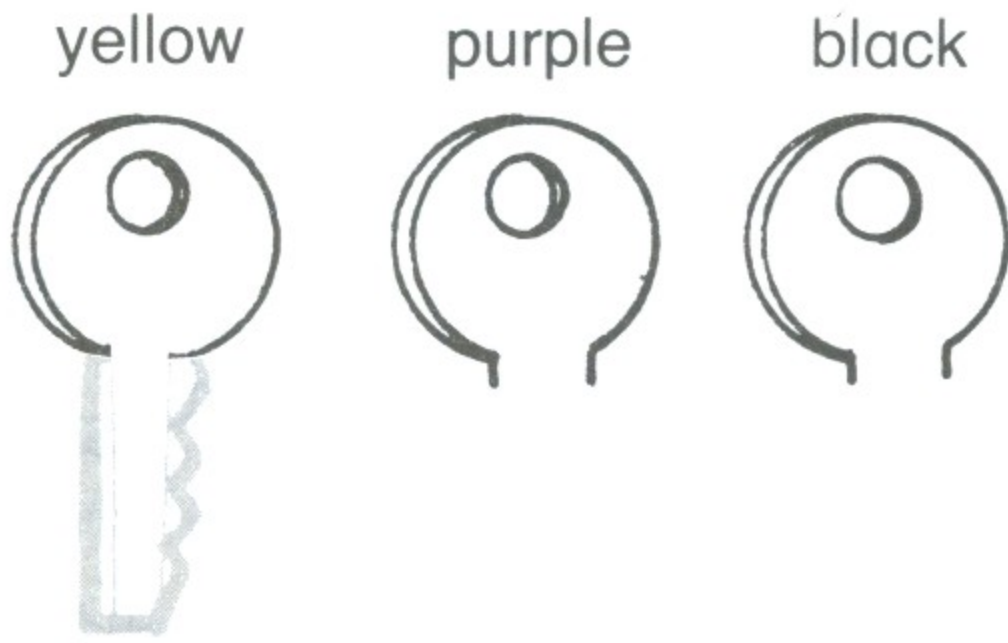
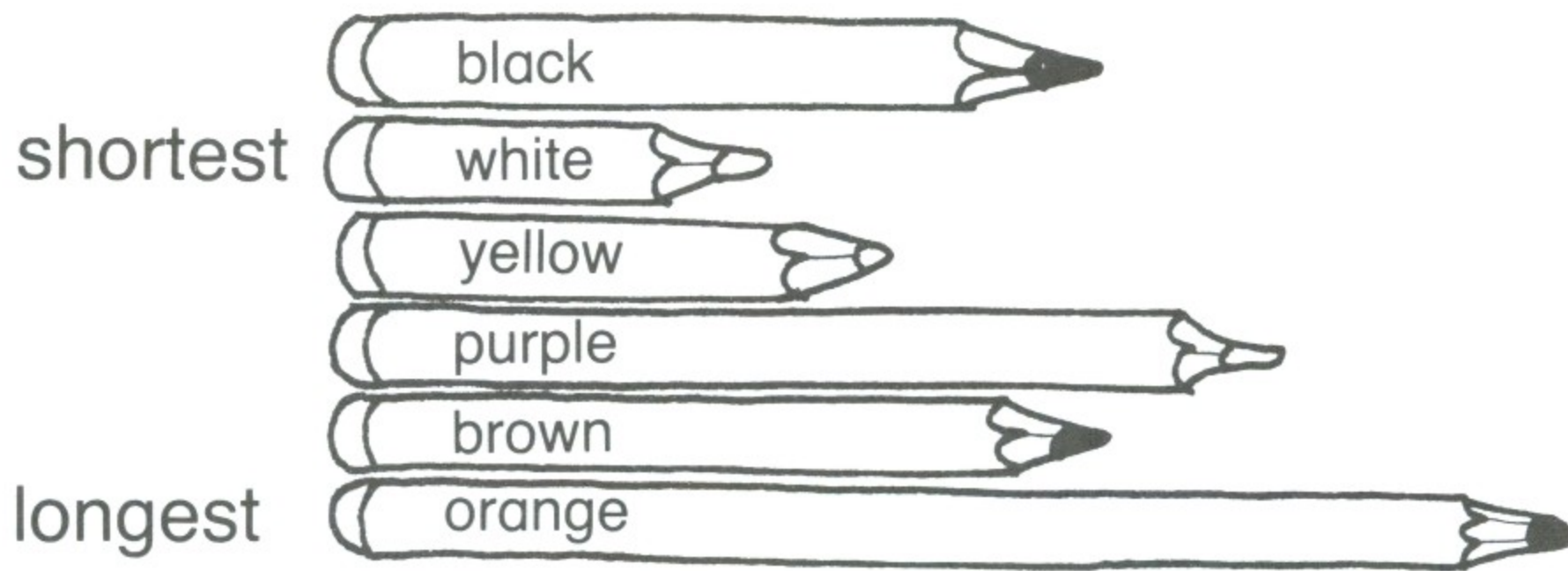

The black key is the longest.
The purple key is the shortest.

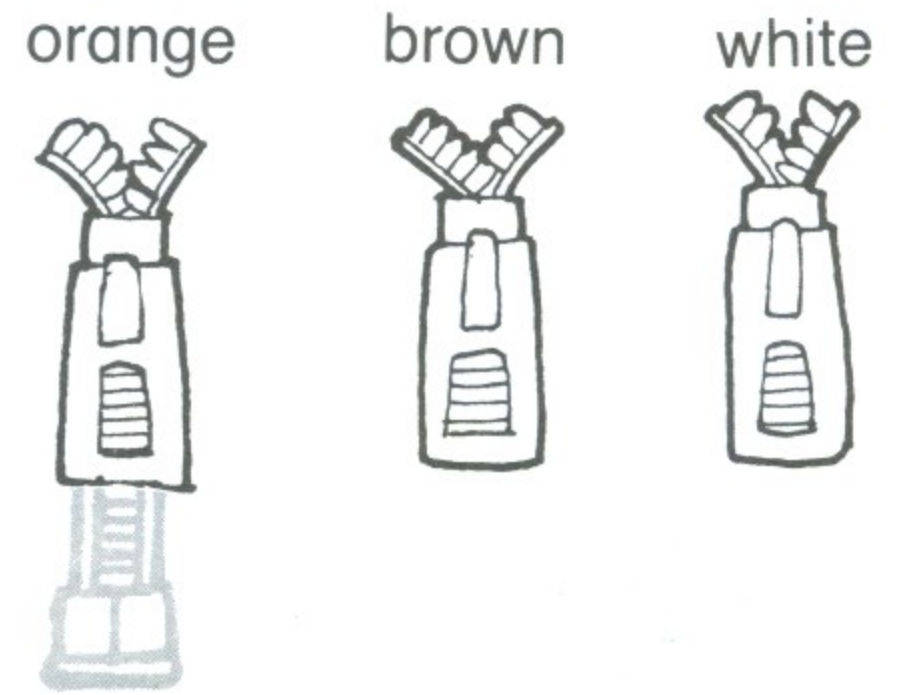

The brown zipper is the longest.
The white zipper is the shortest.

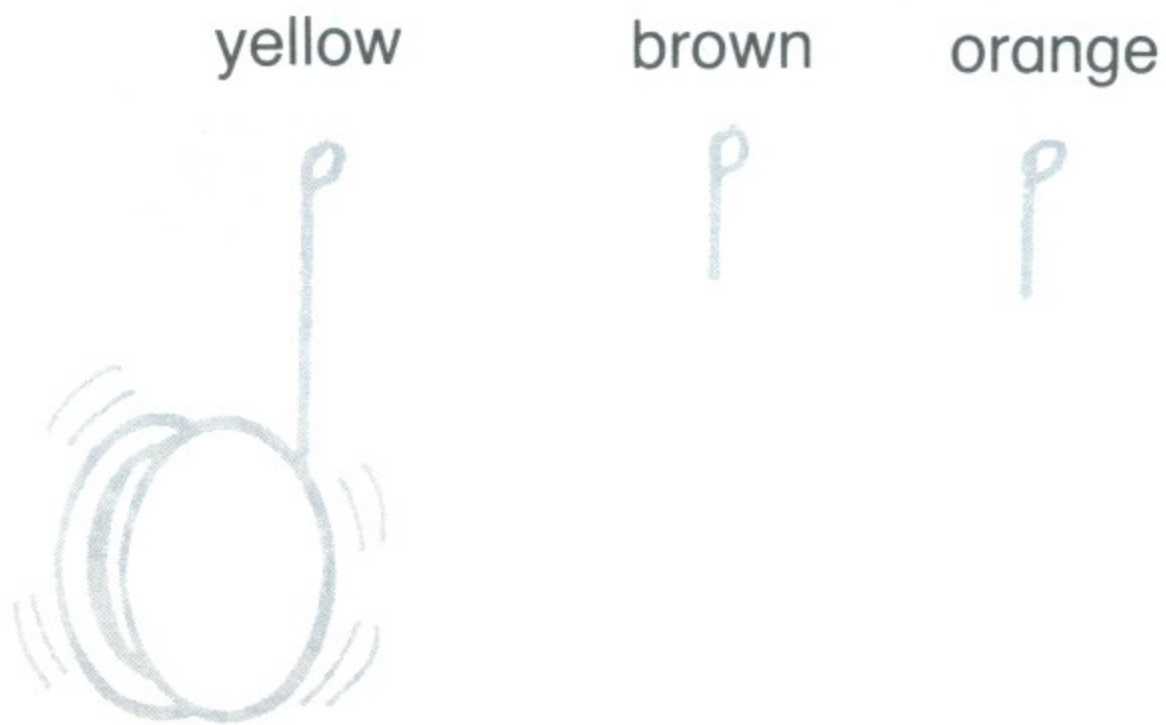

The orange yoyo is the longest.
The brown yoyo is the shortest.

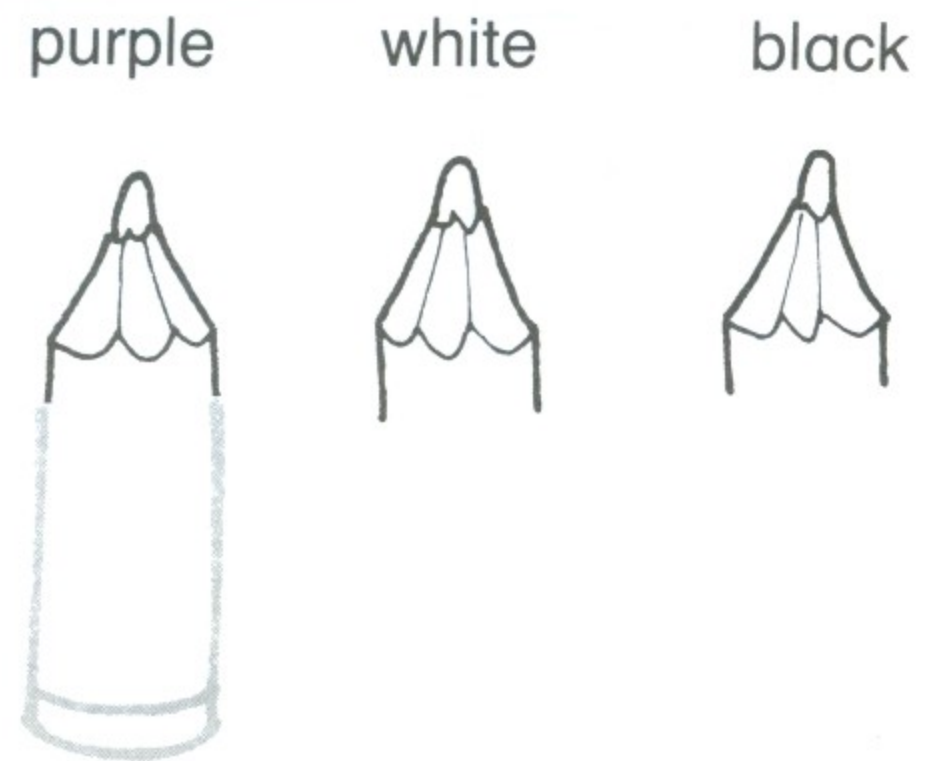

The black pencil is the longest.
The white pencil is the shortest.

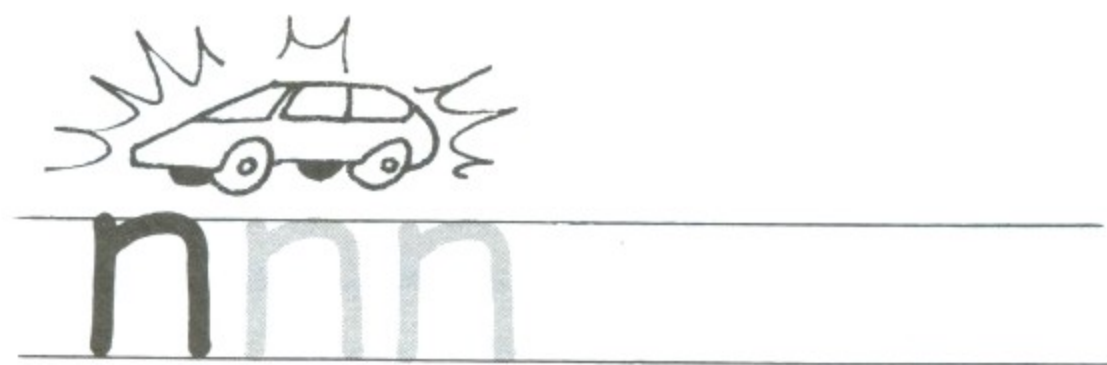

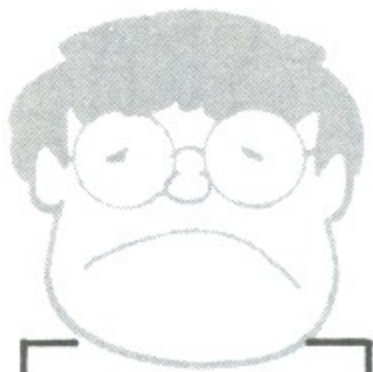

sad



old



young

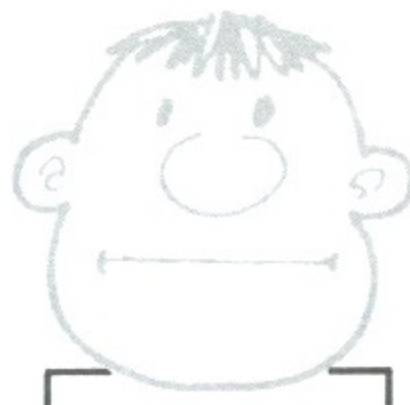

big



tall

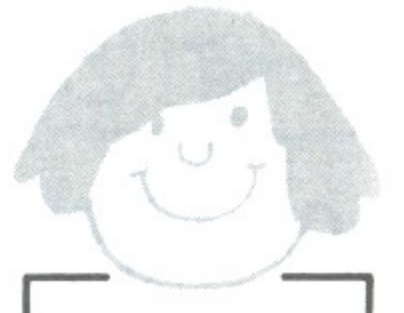

happy

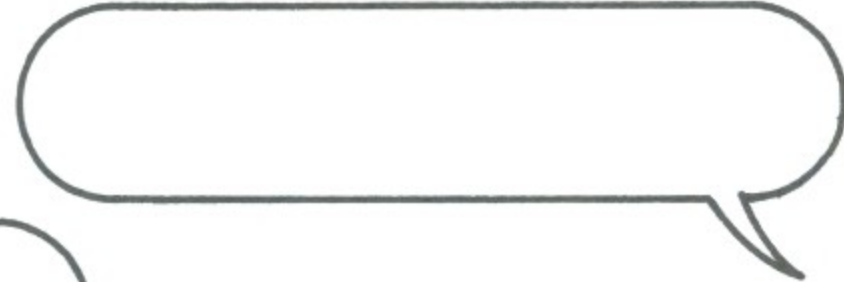

I am the oldest.

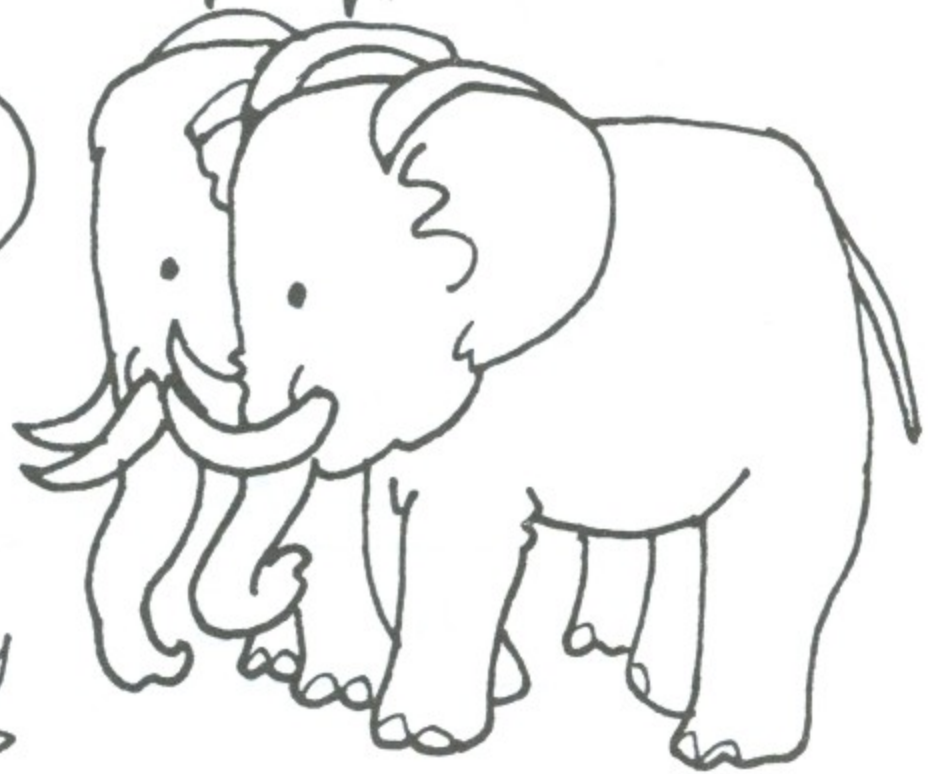
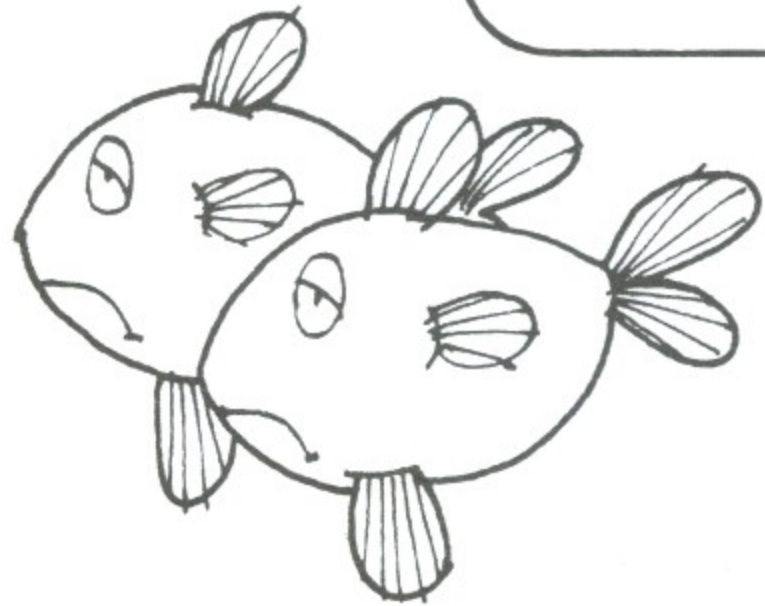
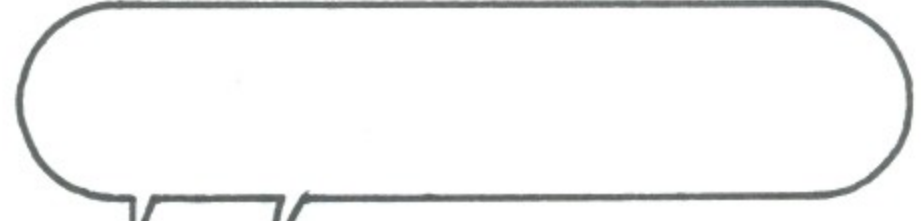
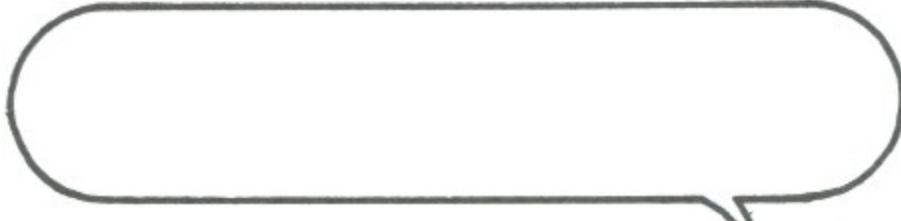
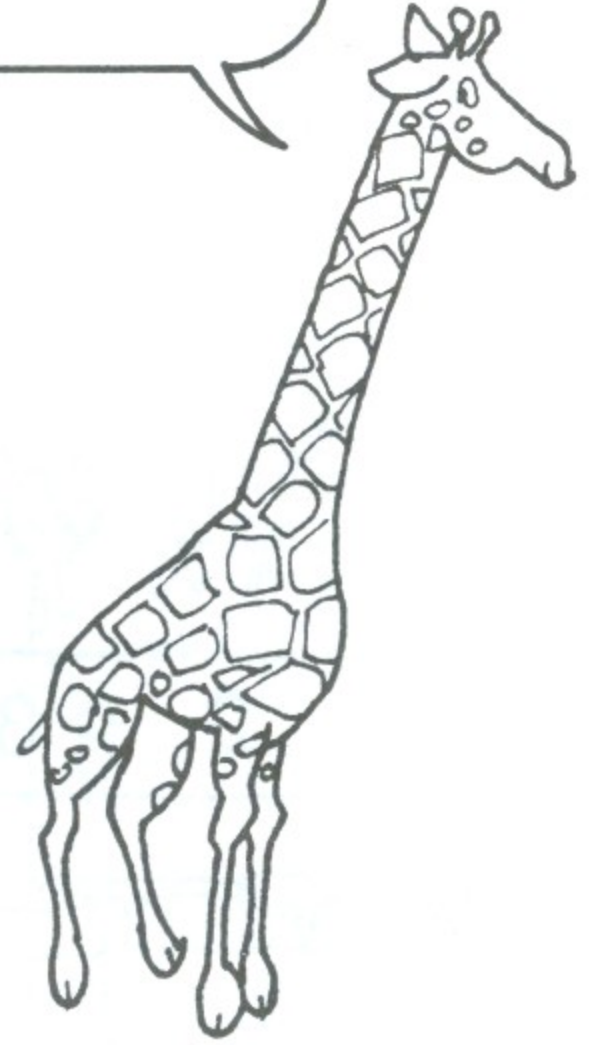
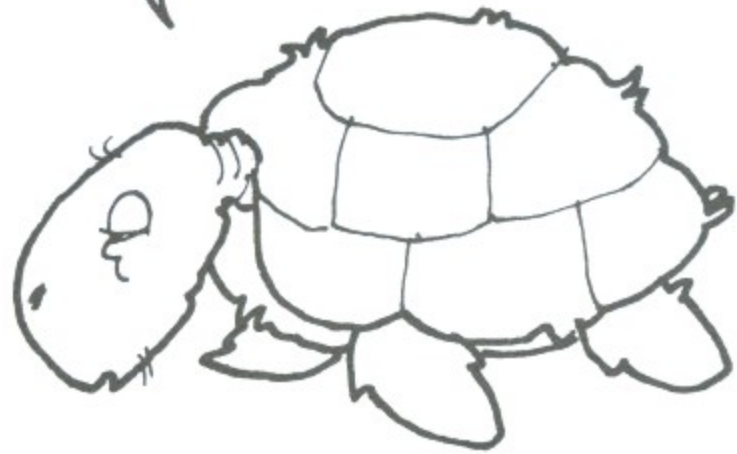

I am the tallest.	I am the youngest.	We are the saddest.
I am the oldest.	We are the biggest.	We are the happiest.

1 2 3 4 5 6 7 8 9 10

one two three four five six seven eight nine ten



three vans.
five



two queens.
one



three zebras.
four



six vans.
ten

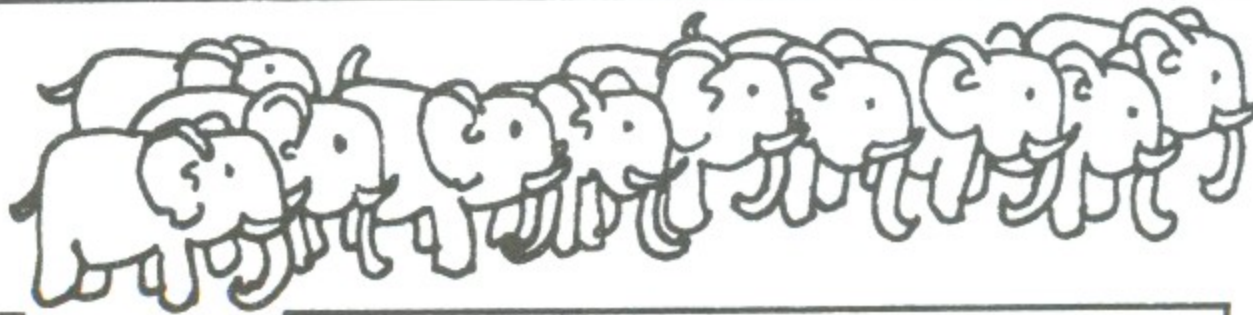

seven elephants.
ten

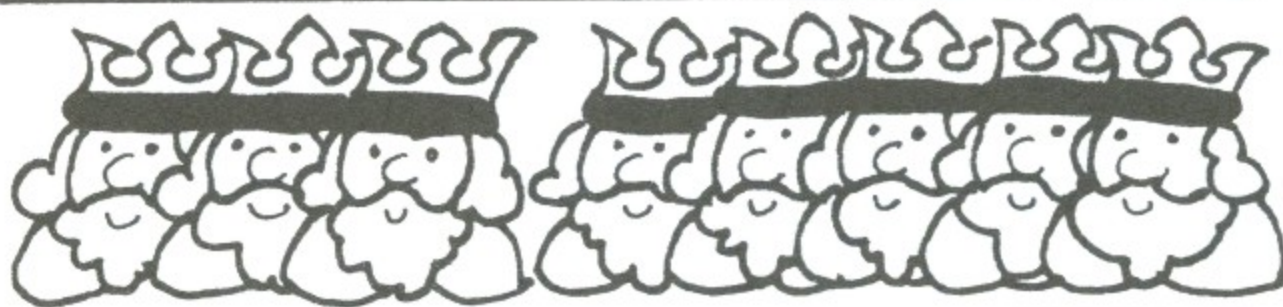

nine kings.
eight

START



1.

Go to three.

elephant

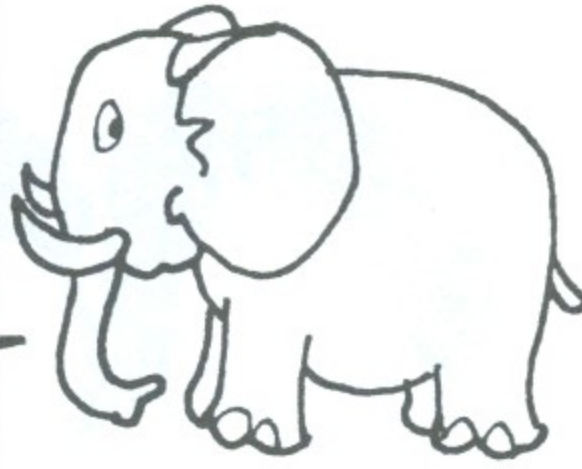

octopus

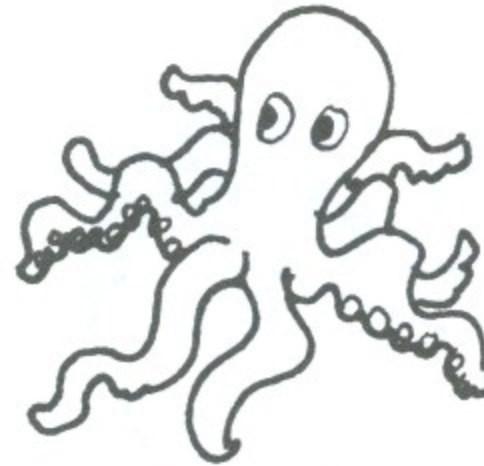

10.

Go to the zoo.

2.

Color the octopus yellow. Then go to seven.

9.

Go back to two.

3.

Color the elephant brown. Then go to five.



lion



zebra

8.

Go to ten.

4.

Color the lion brown. Then go to eight.

5.

Go to six.

6.

Color the zebra black and white. Then go to nine.

7.

Go back to four.



l l l



j j j

l j l j



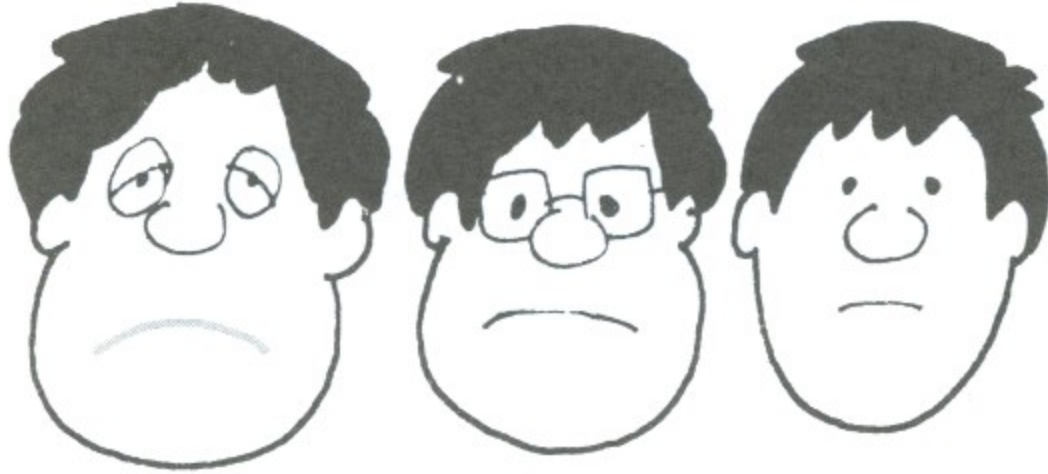
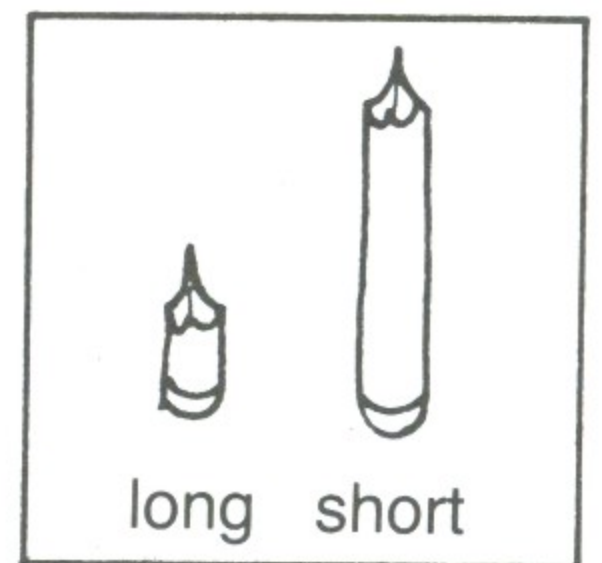
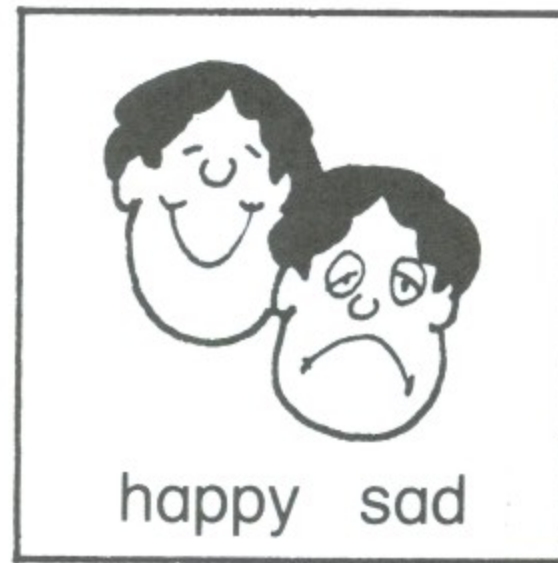
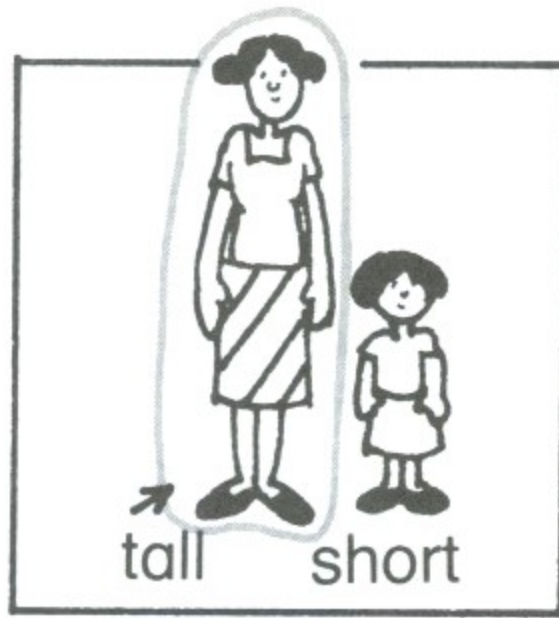
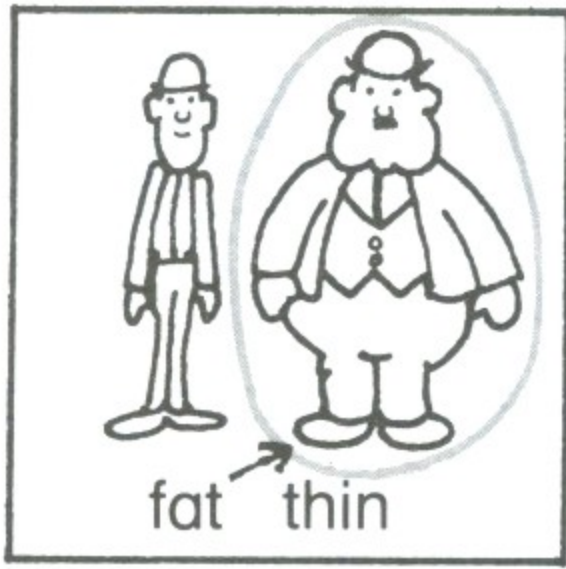

He is the saddest.

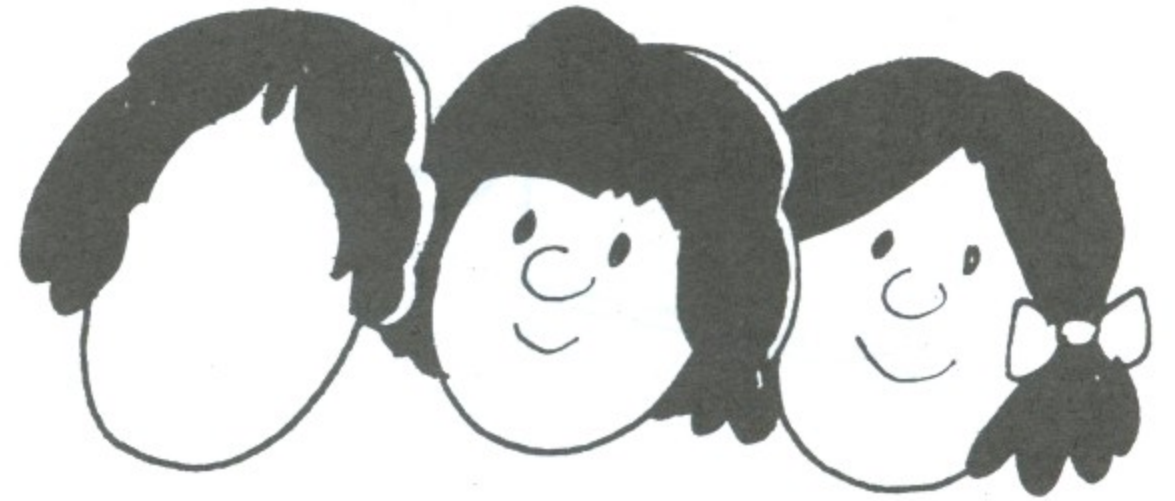

She is the happiest.

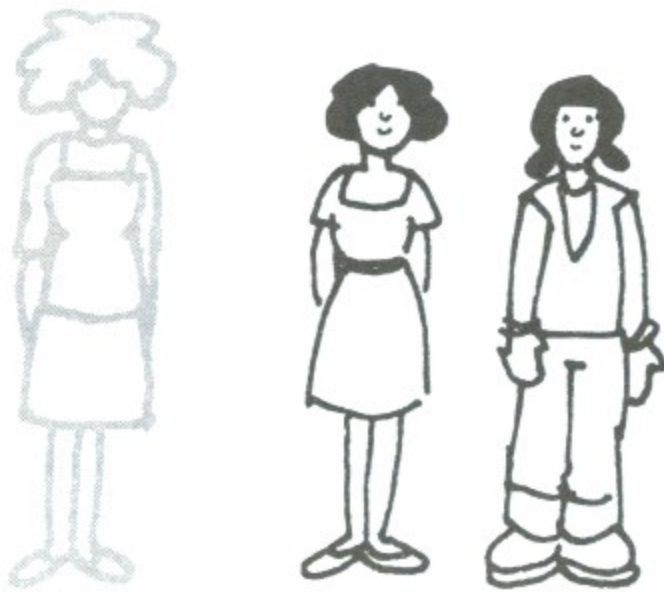

She is the tallest.



He is the shortest.

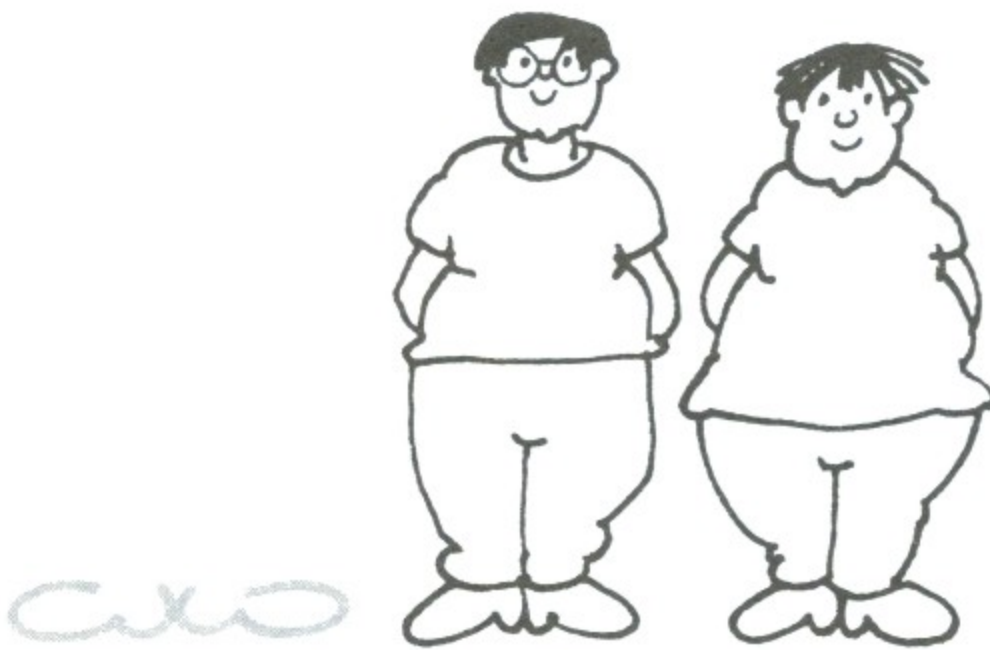

He is the fattest.

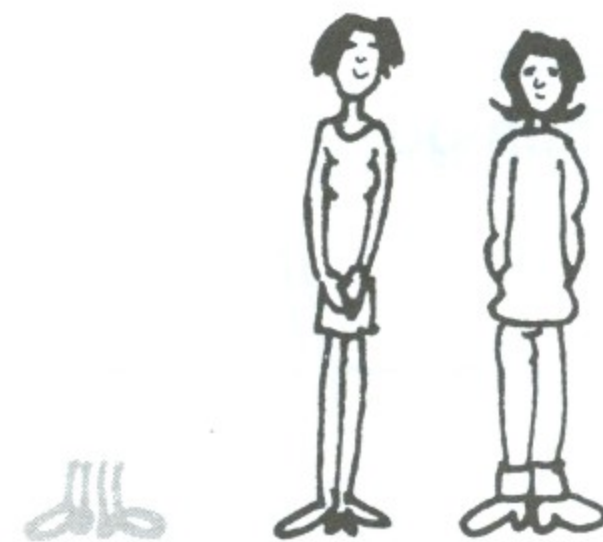

She is the thinnest.

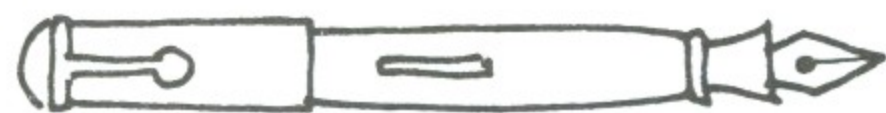

It is the shortest.



It is the longest.

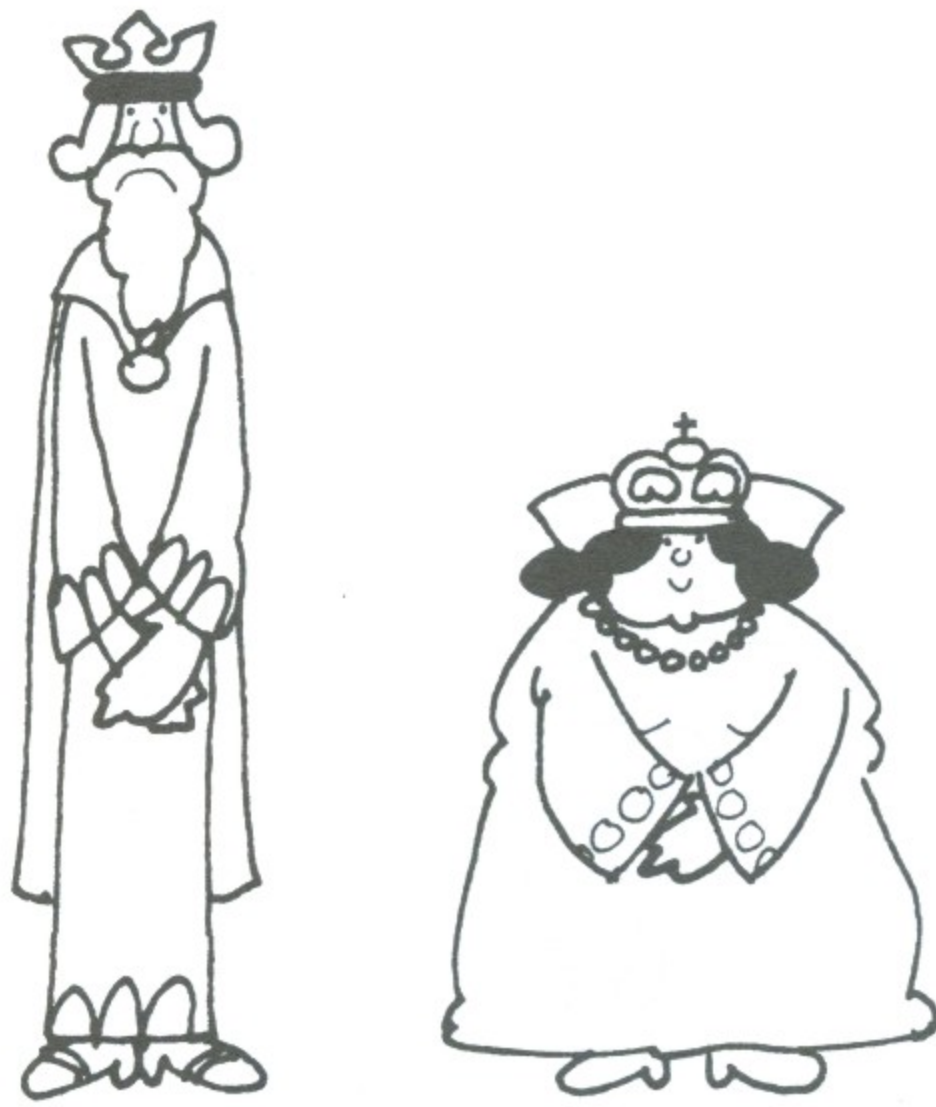

Look at the queen.

Is she the tallest?

Is she the shortest?

Is she the fattest?

Is she the saddest?

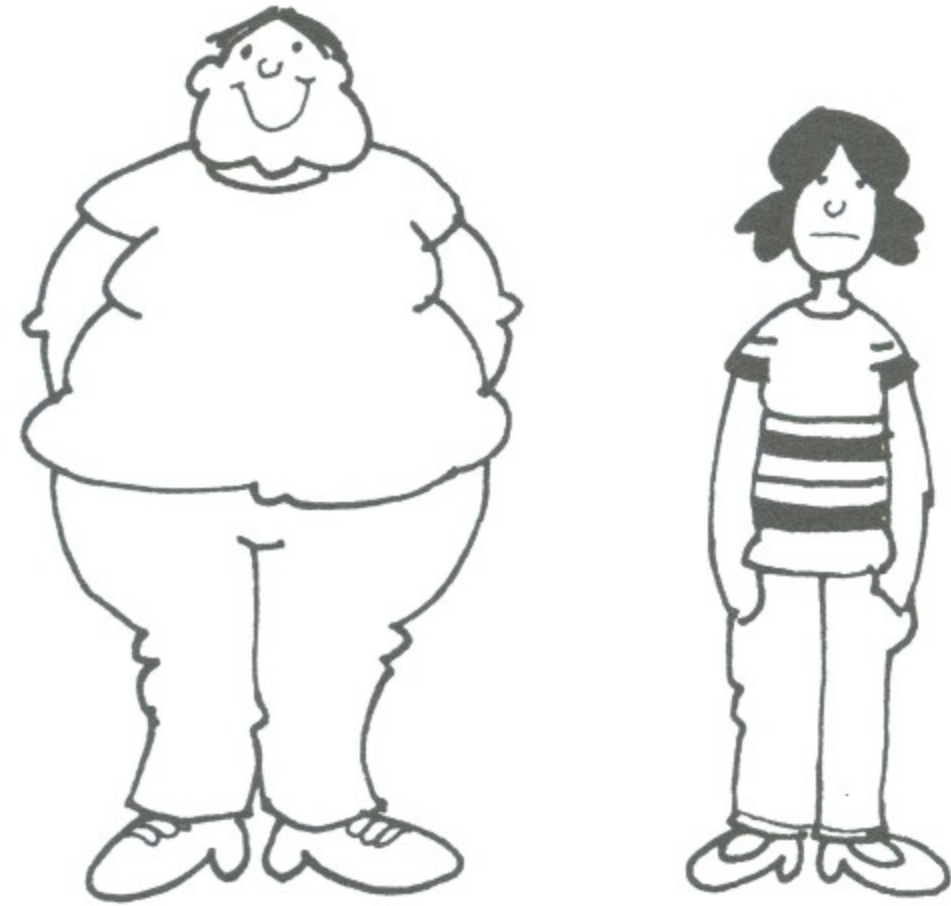

Yes, she is. No, she isn't.

Yes, she is. No, she isn't.

Yes, she is. No, she isn't.

Yes, she is. No, she isn't.

Look at the king.

Is he the thinnest?

Is he the shortest?

Is he the tallest?

Is he the saddest?

Yes, he is. No, he isn't.

Yes, he is. No, he isn't.

Yes, he is. No, he isn't.

Yes, he is. No, he isn't.



t t t



f f f



f

t f t f



king

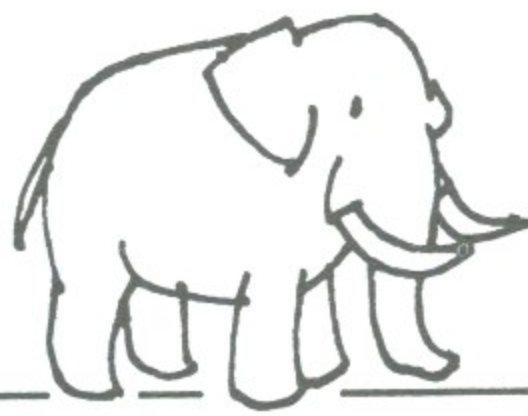

elephant



zebra

z

k

e

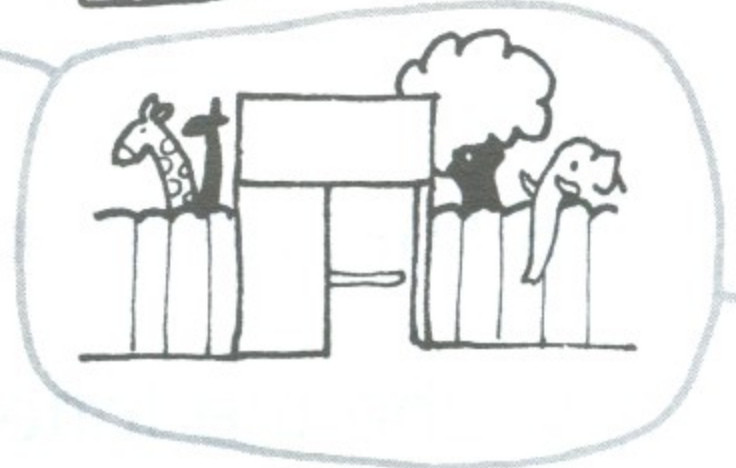
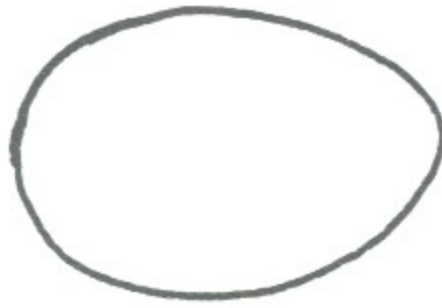
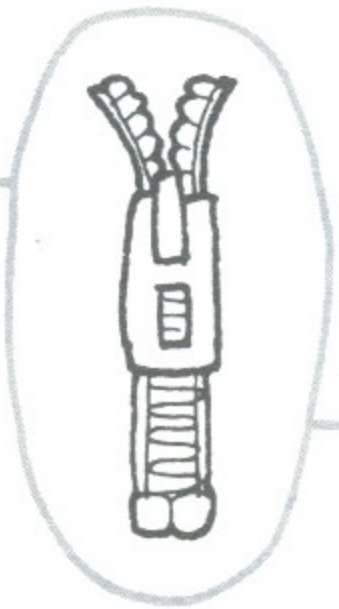

e

k

z



queen



van



yes

q

y

v



y

v

q

v v v

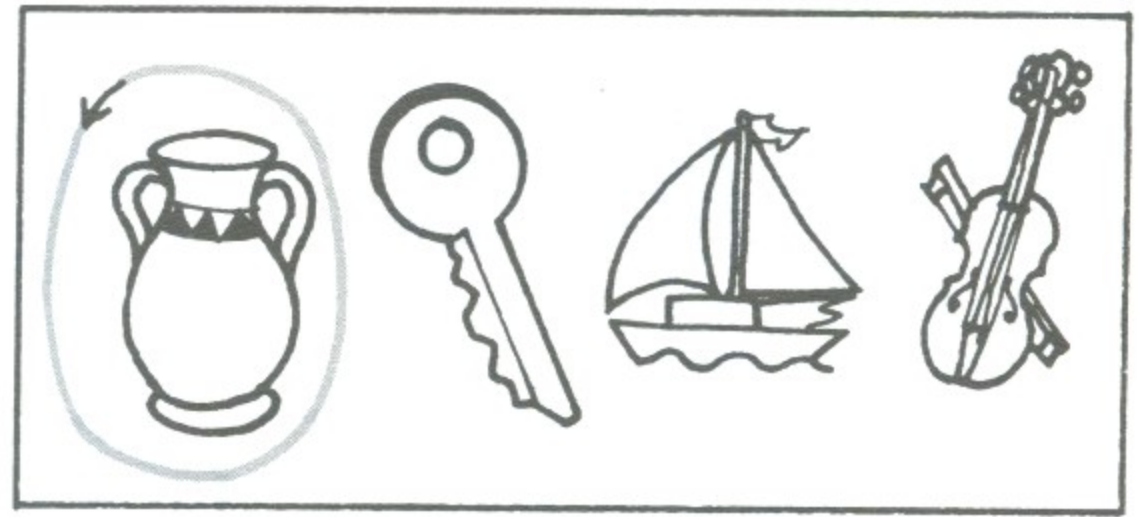

y y y

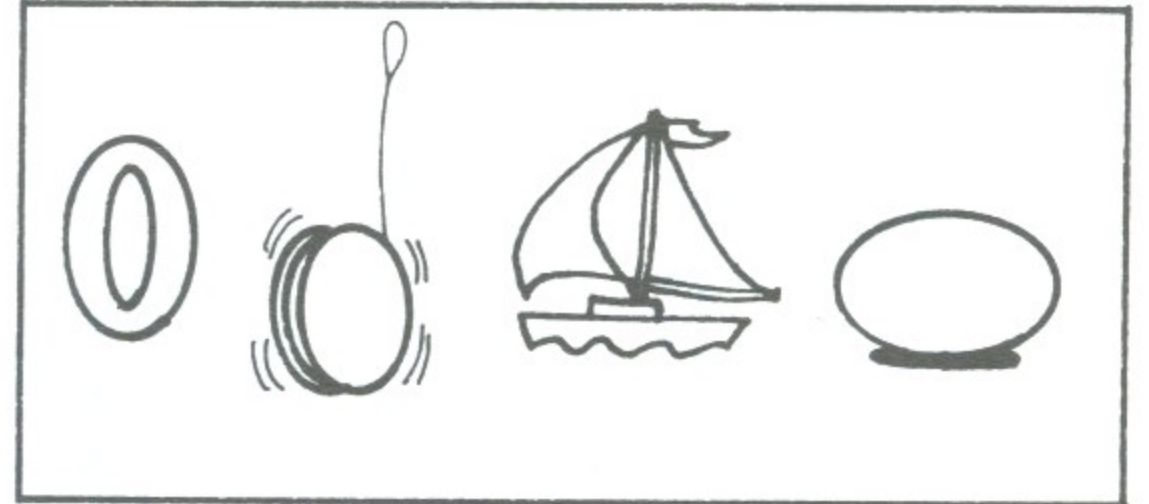

z z z

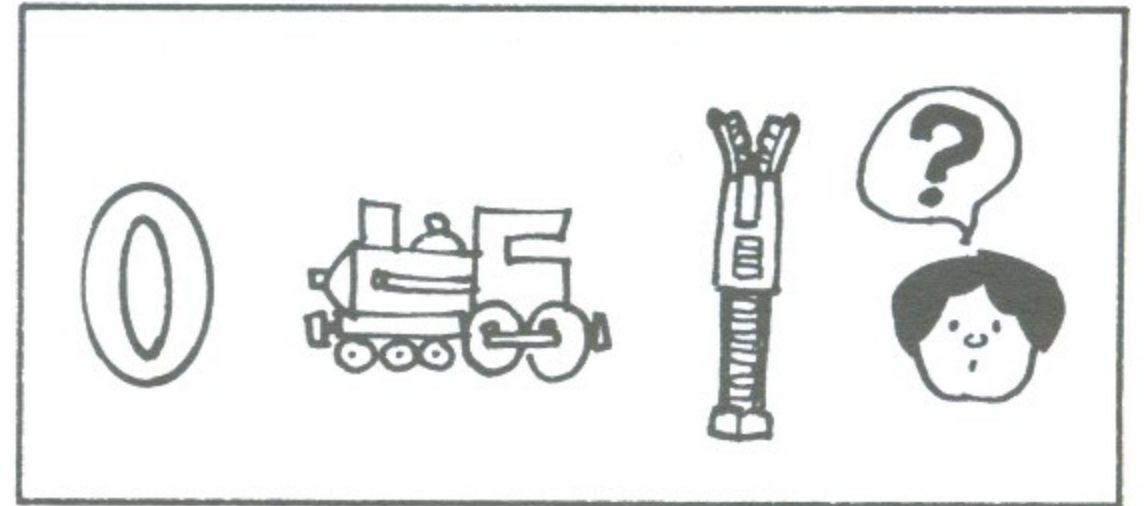

k k k

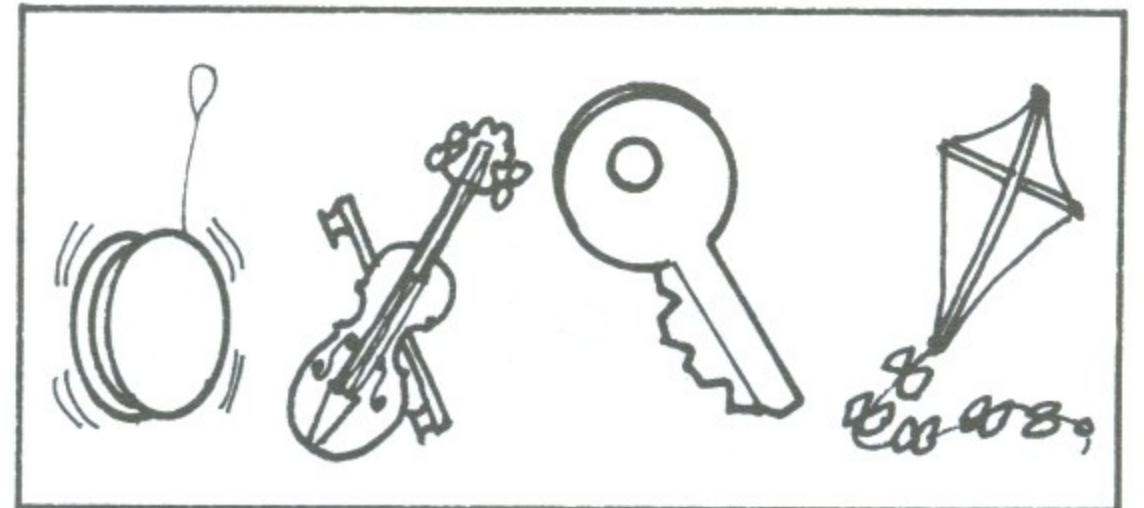

e e e

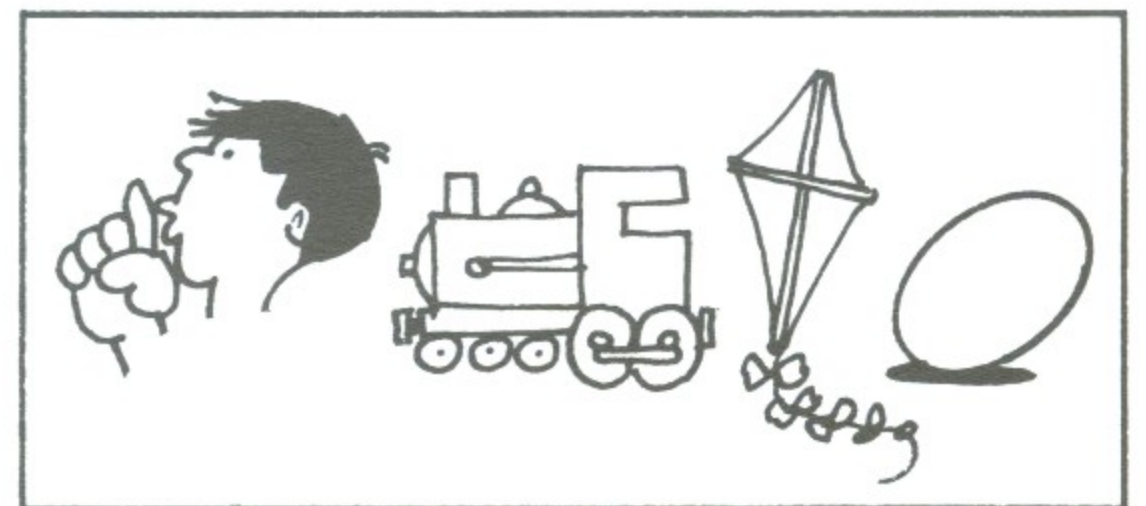

q q q

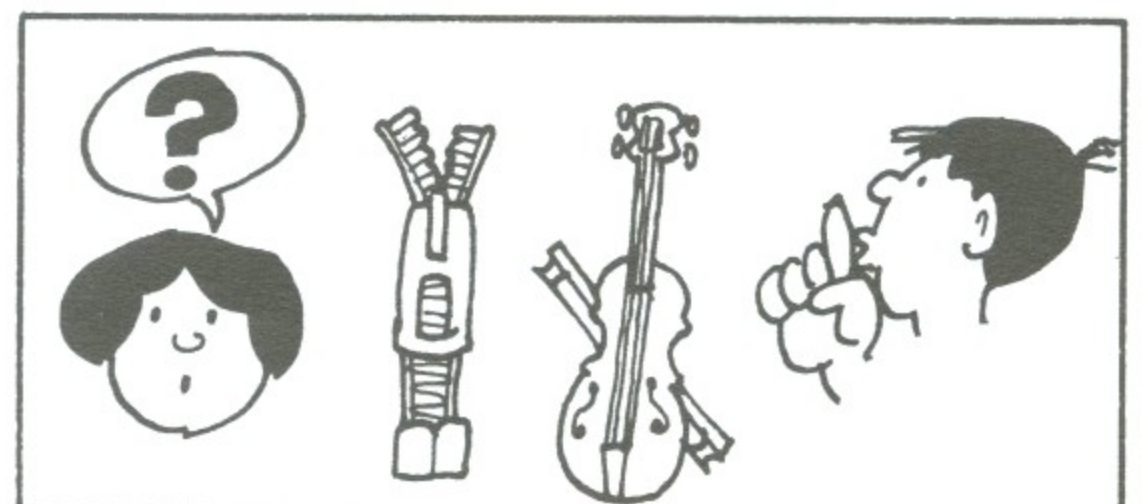



She is happy.



She isn't happy.



He is happy.

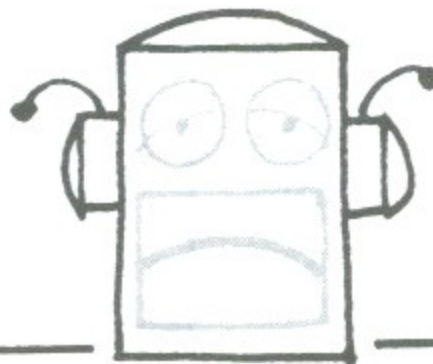

It isn't happy.



She isn't happy.

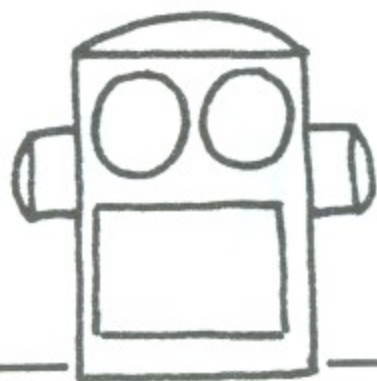

It is happy.



He isn't happy.



She is happy.

Draw a pink cat.
It is happy.

Draw a purple fish.
It isn't happy.



a a a



q q q

a q a q



a

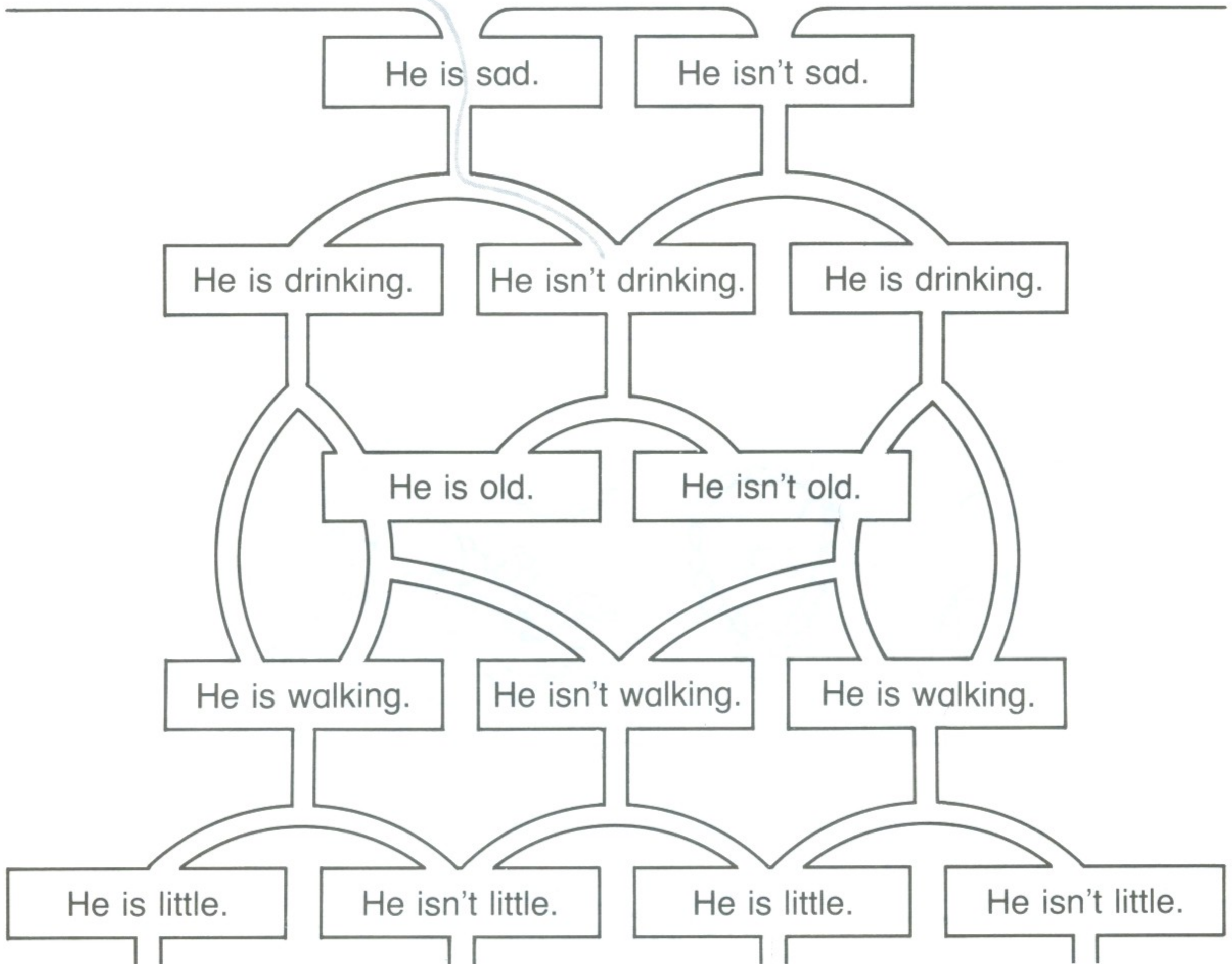
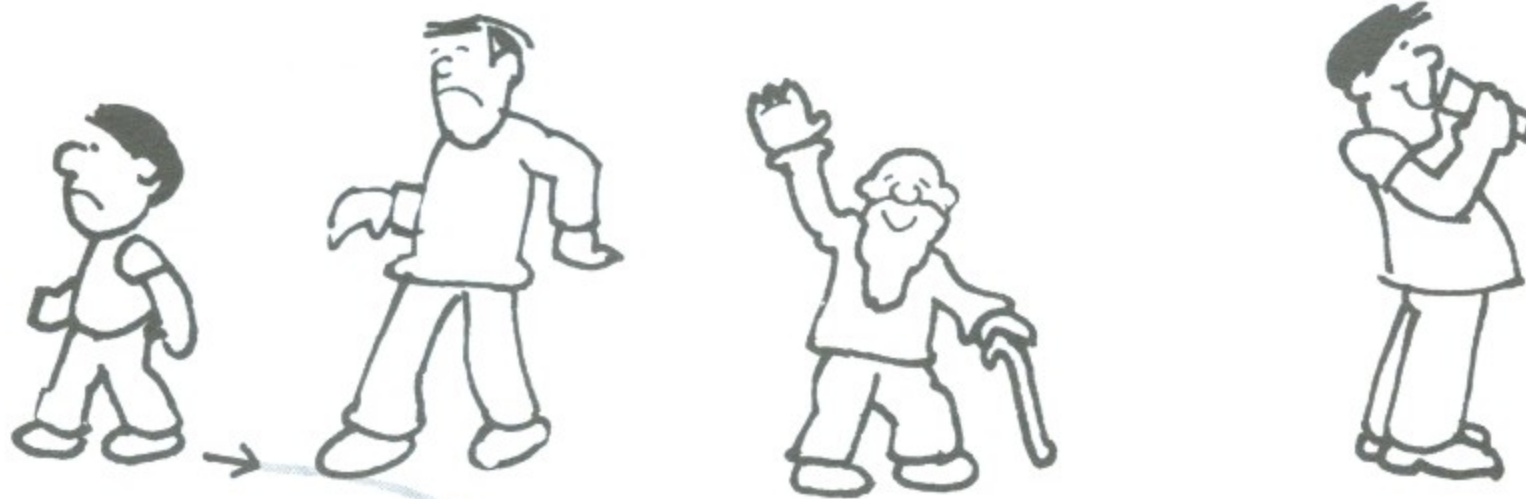
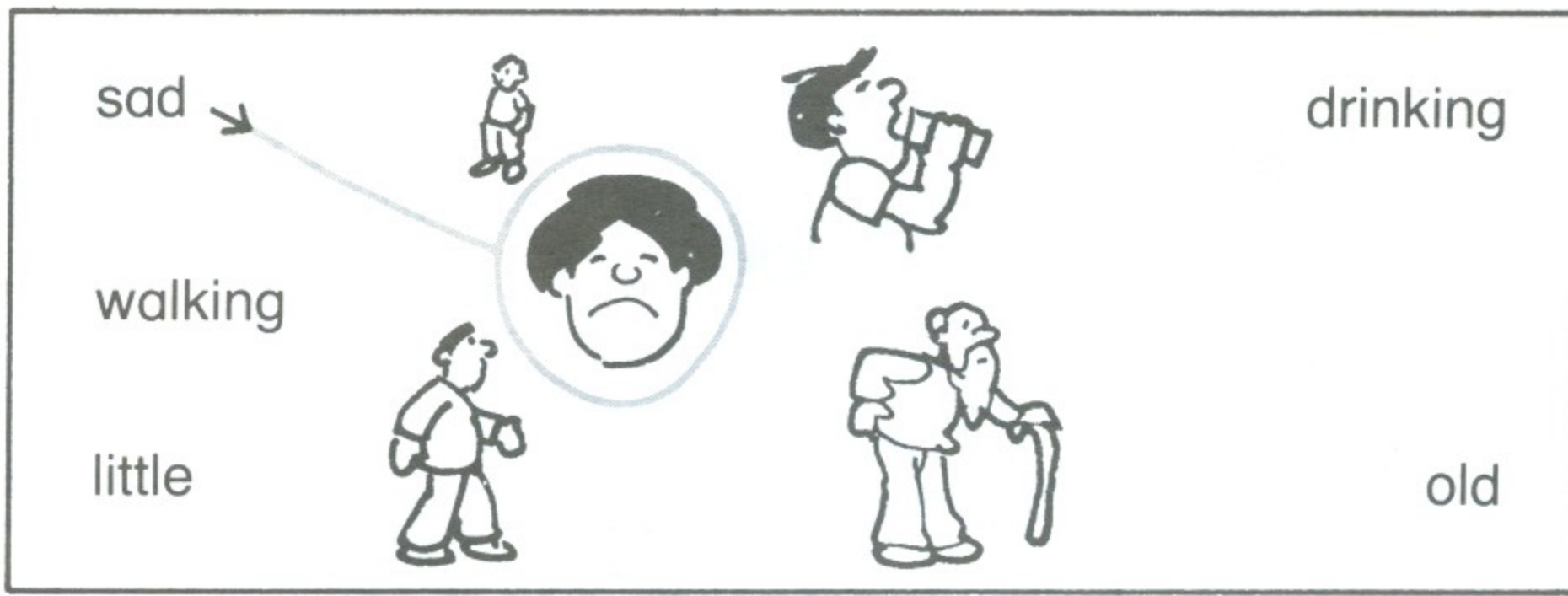

m
c
b

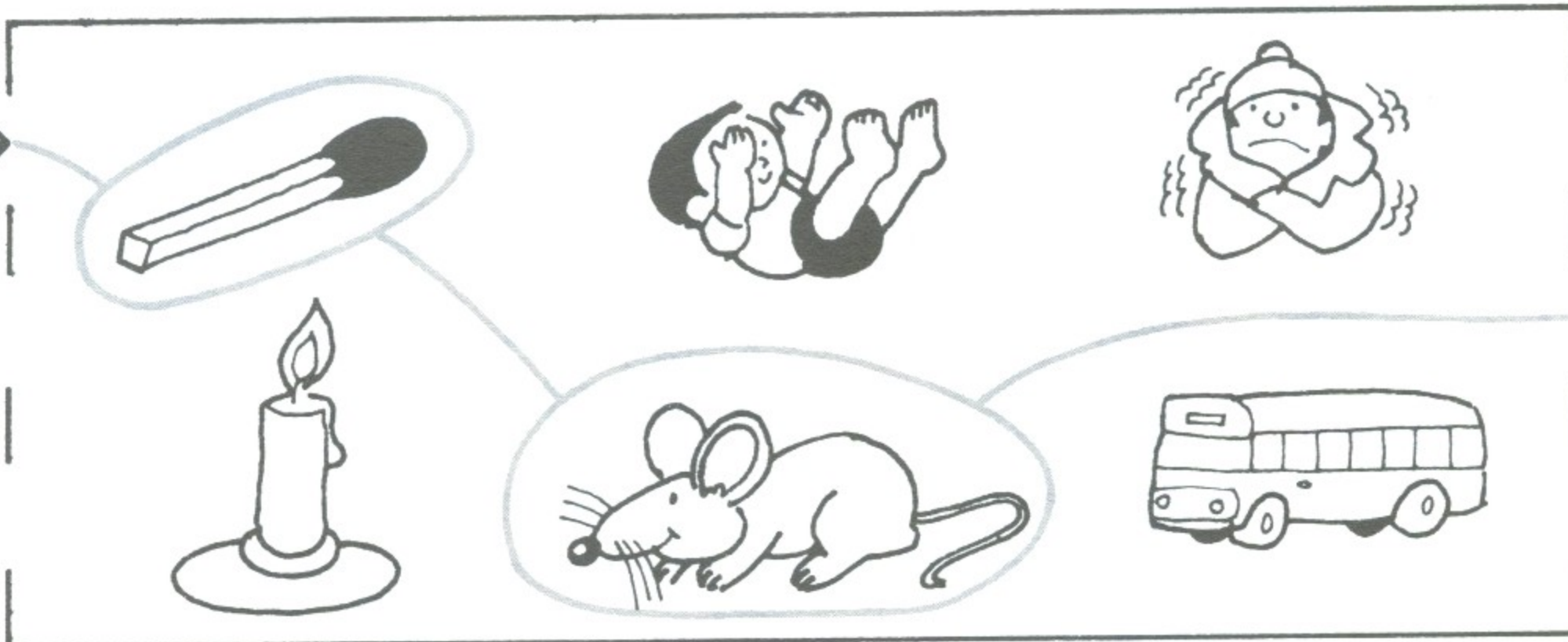

c
m
b

t
a
f

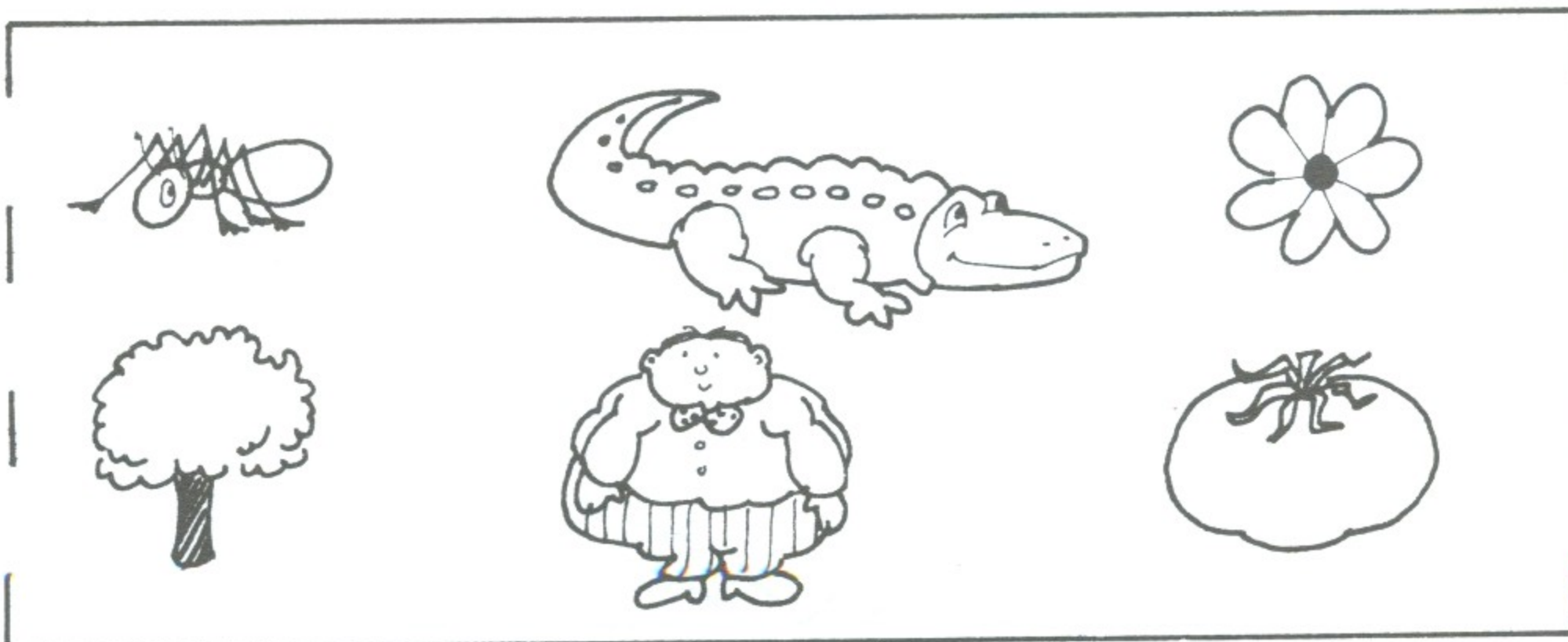

f
t
a

n
o
h

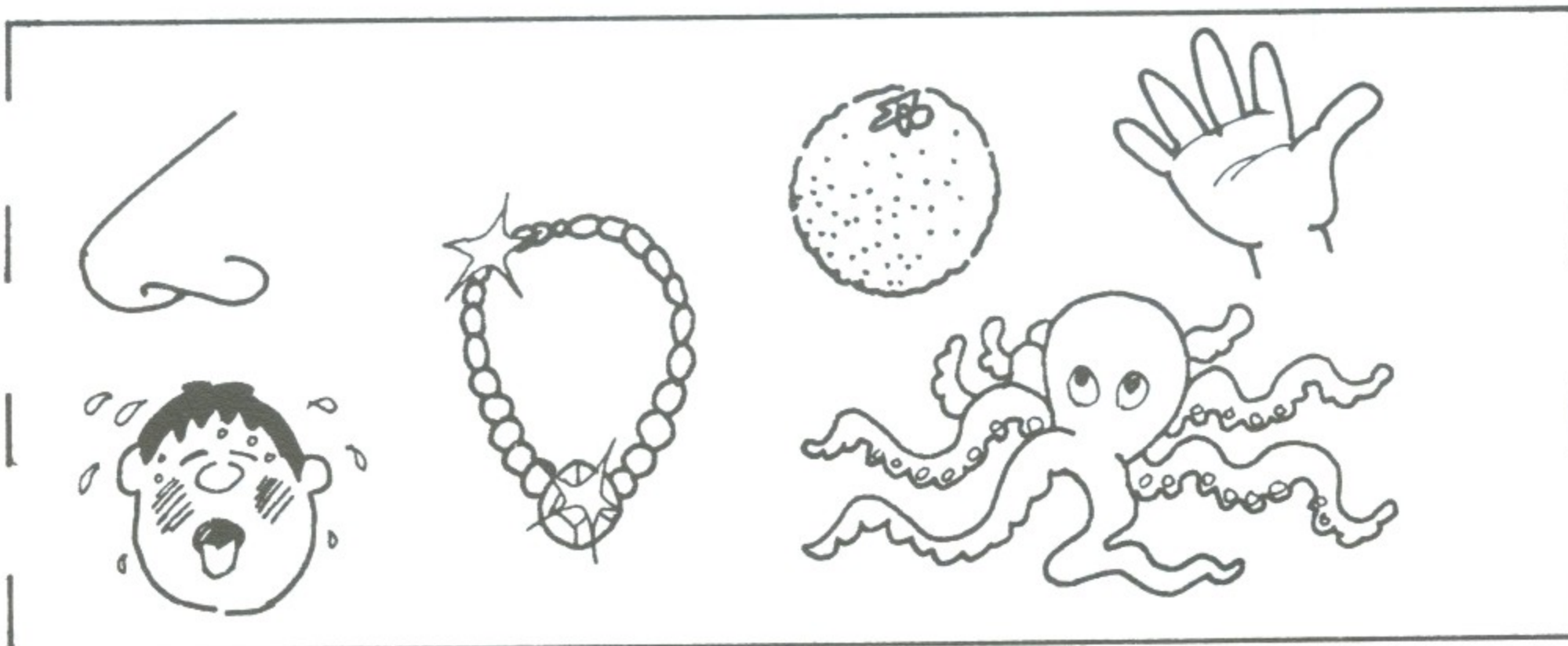

o
h
n

i
s
i

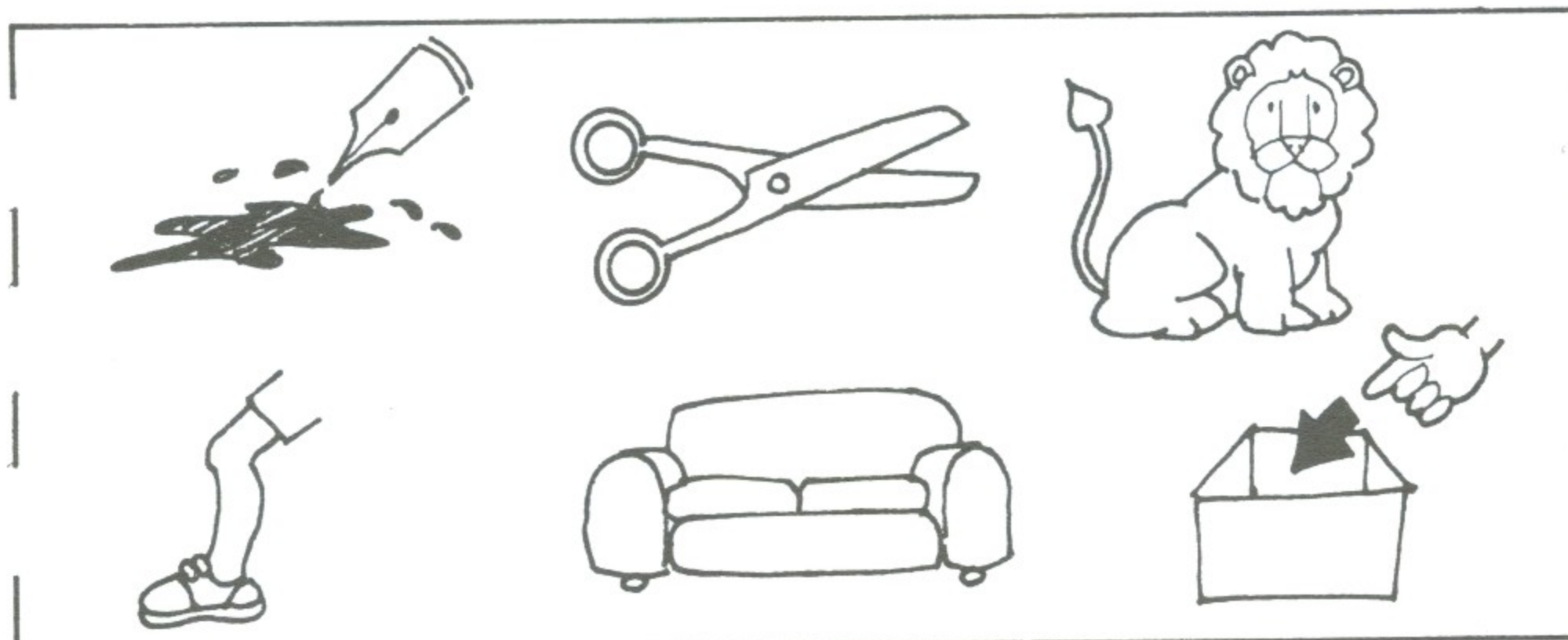

i
s

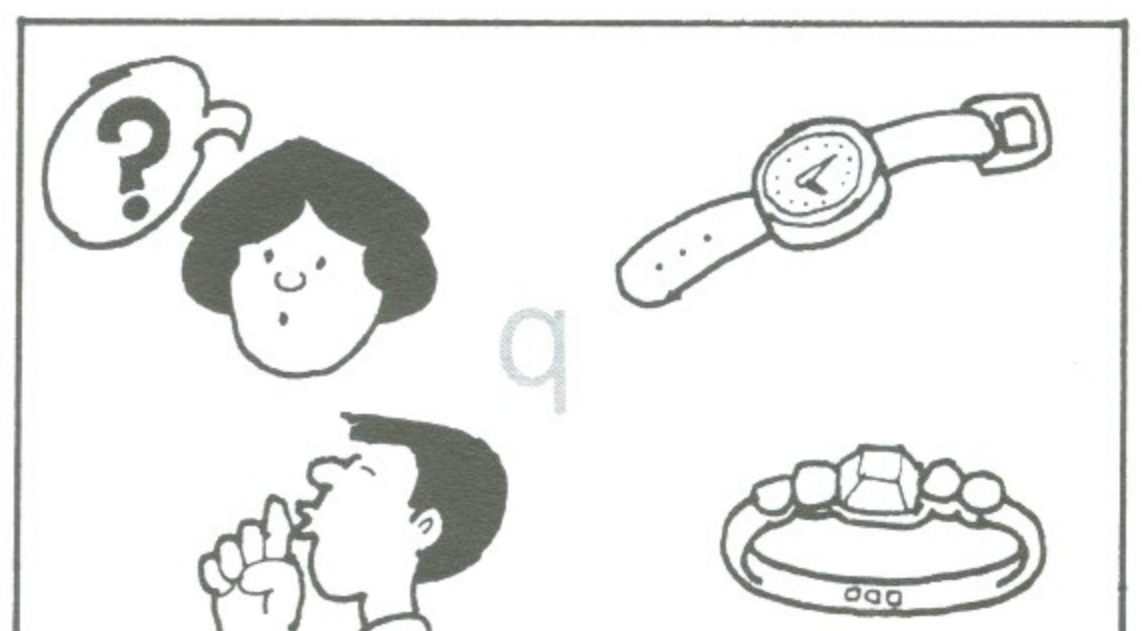
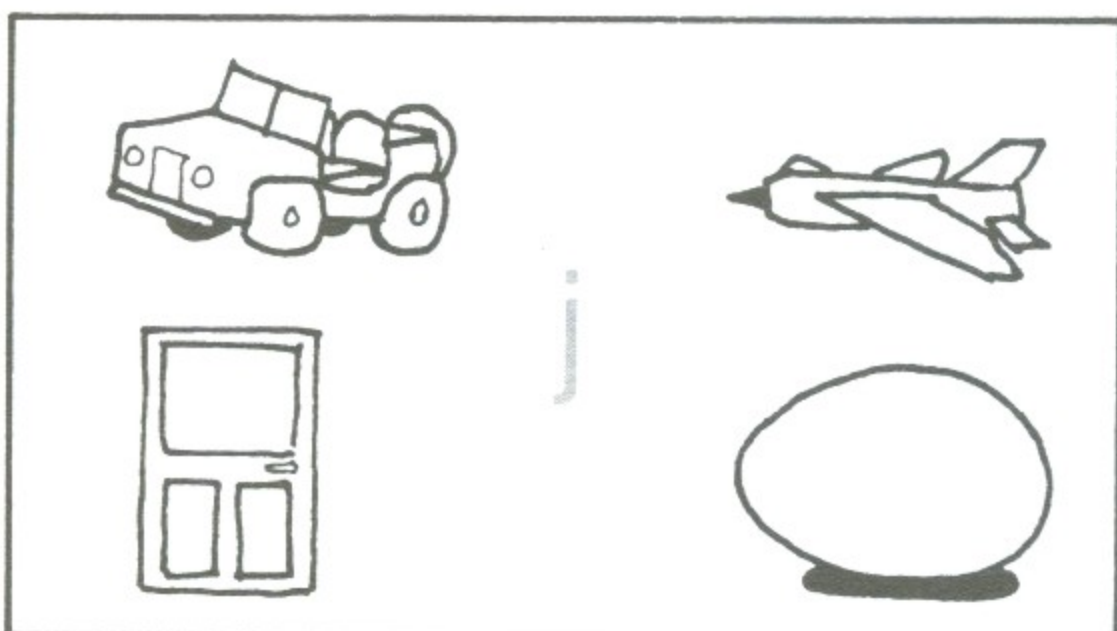
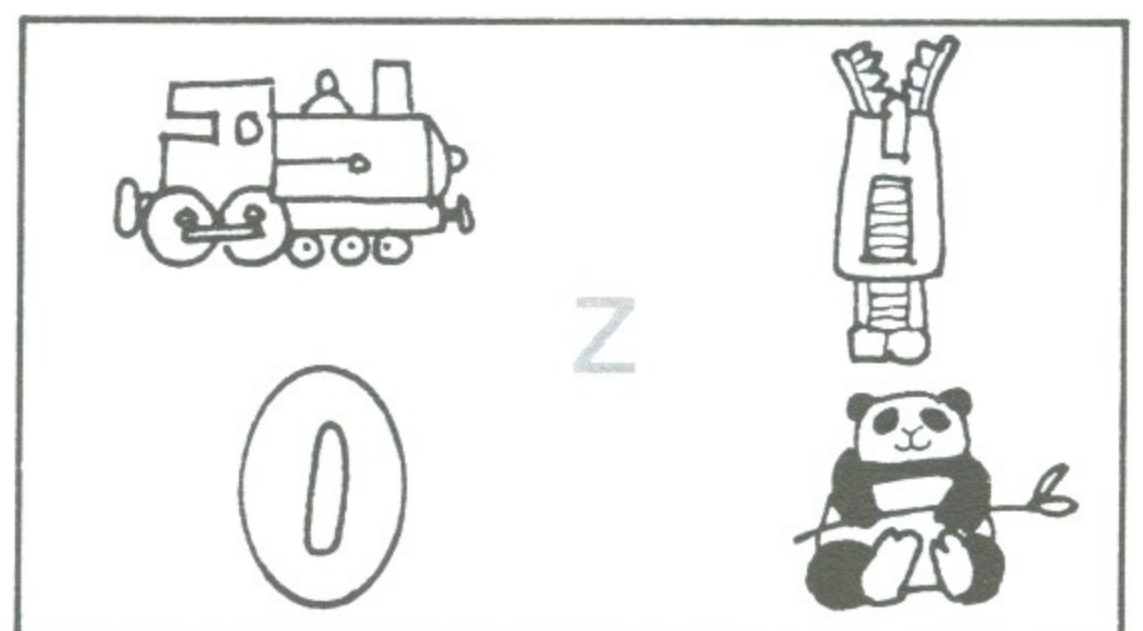
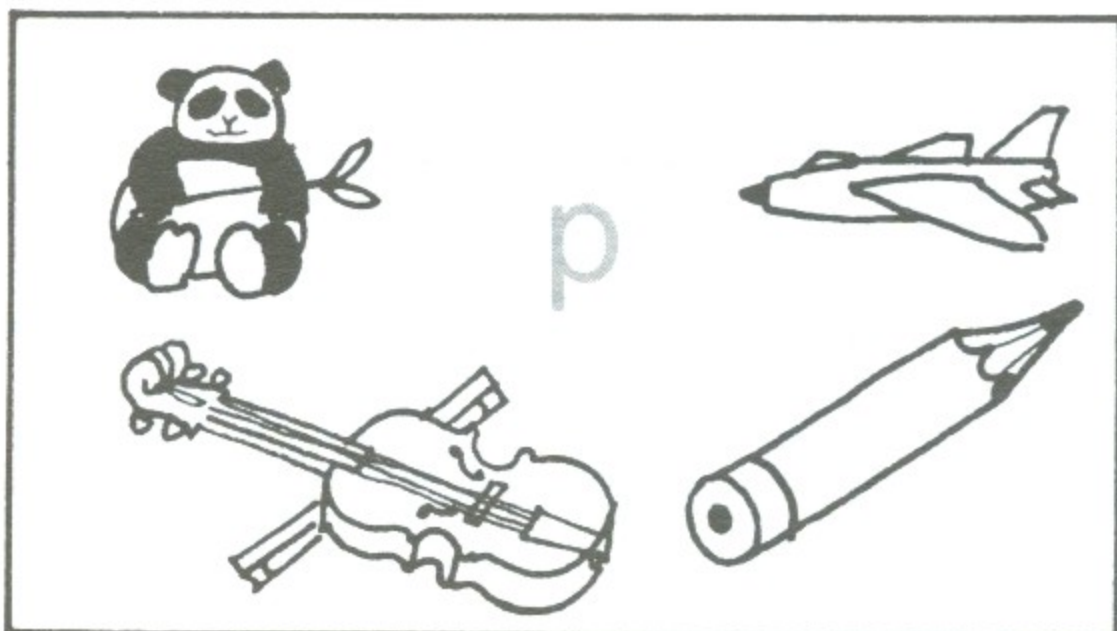
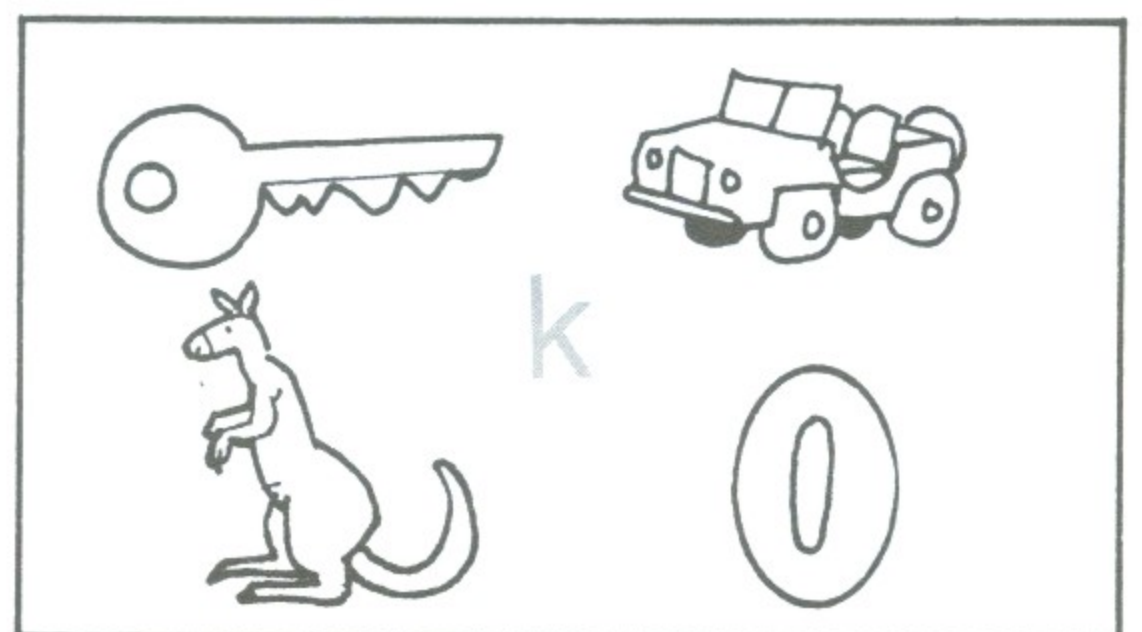
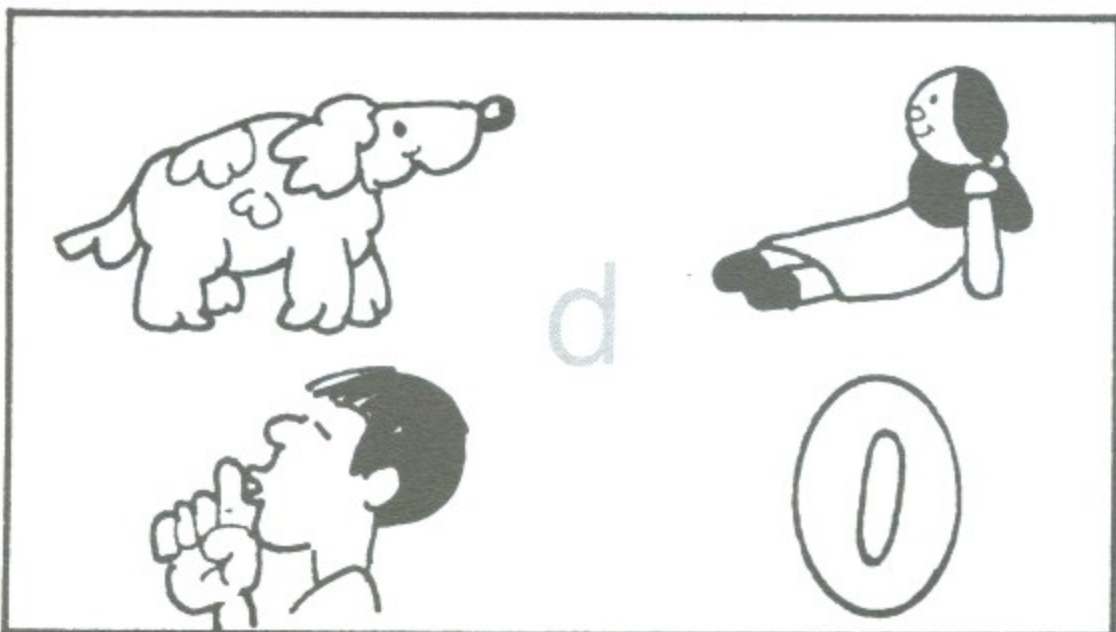
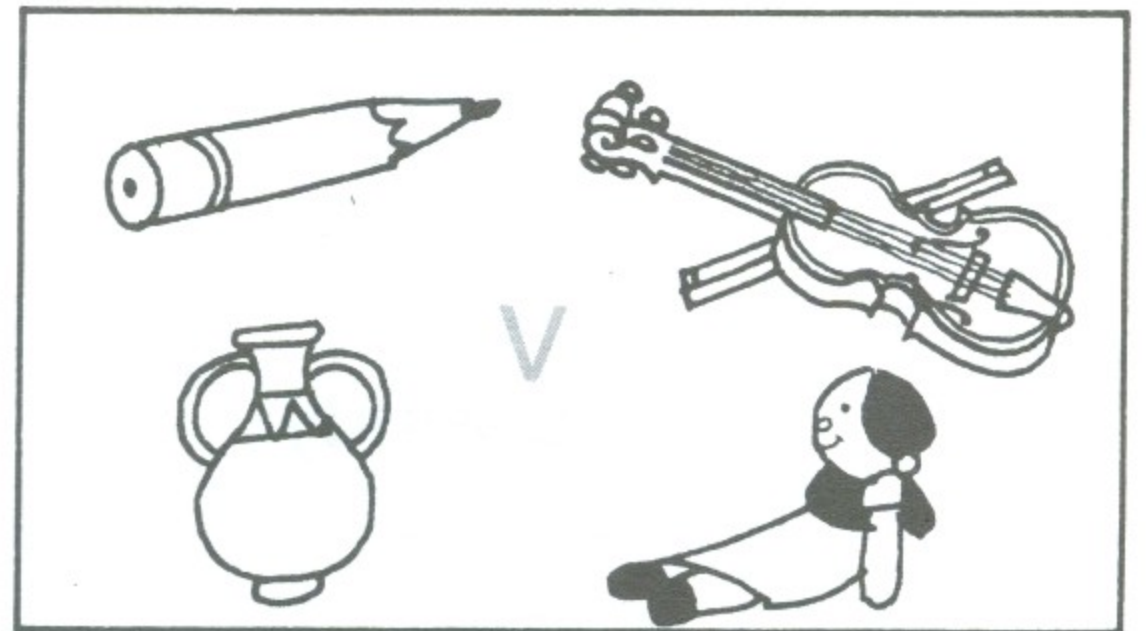
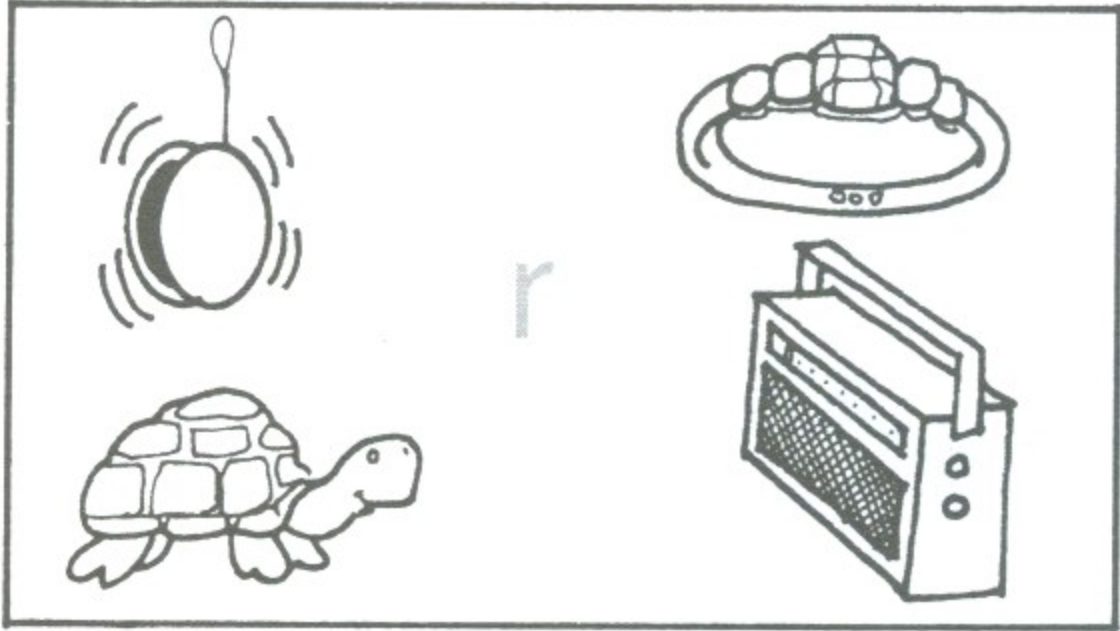
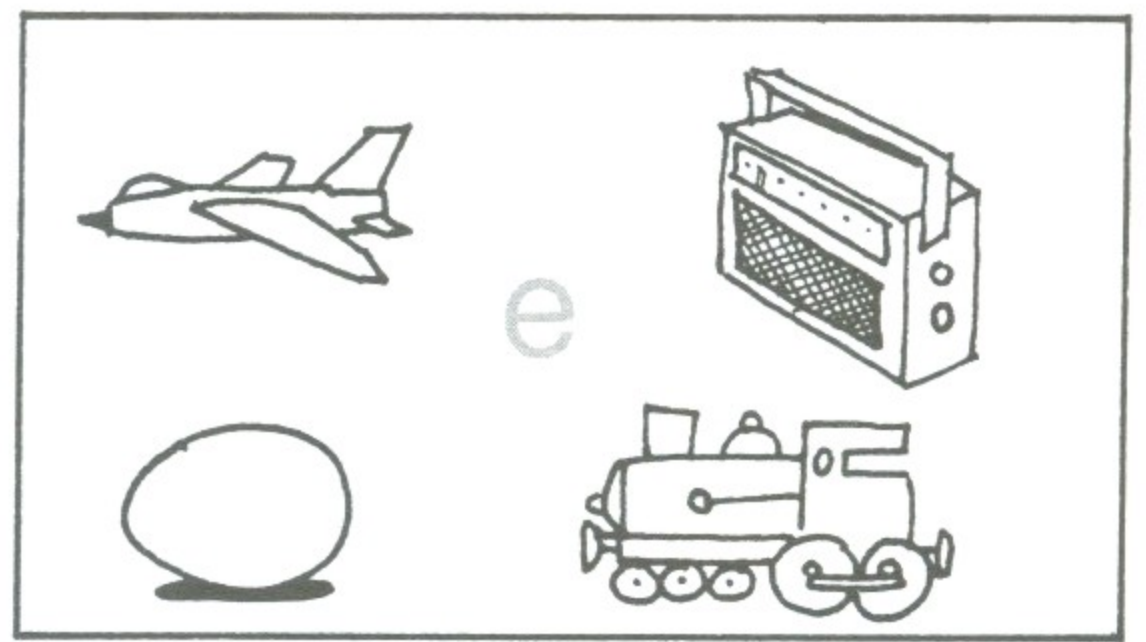
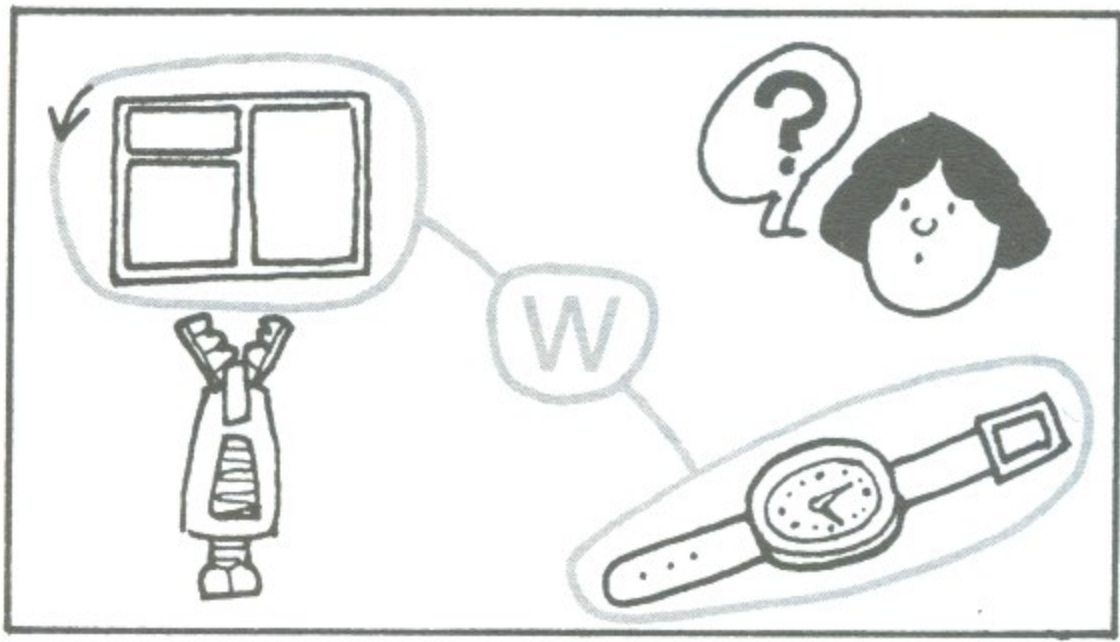

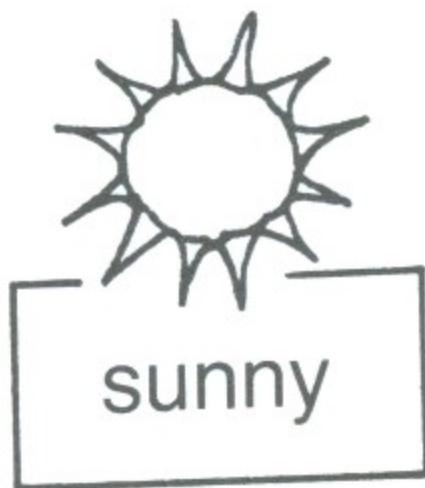

sunny

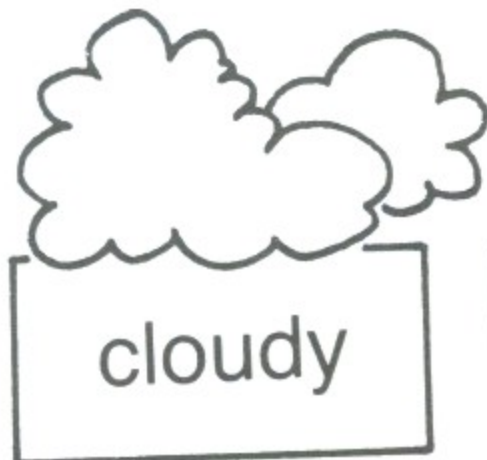

cloudy



snowing



windy



raining



It is windy.



It is cloudy.

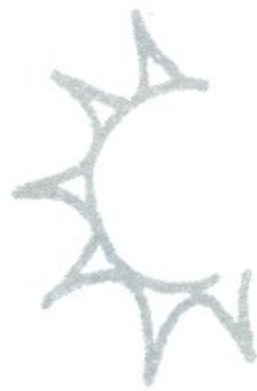

It is sunny.

It is snowing.

It is raining.



Is it raining today?

Yes, it is. No, it isn't.

Is it snowing today?

Yes, it is. No, it isn't.

Is it sunny today?

Yes, it is. No, it isn't.

Is it windy today?

Yes, it is. No, it isn't.

Is it cloudy today?

Yes, it is. No, it isn't.



rrr

nrnr



rrr



r

Draw today's ⇨
weather.

sunny cloudy snowing windy raining

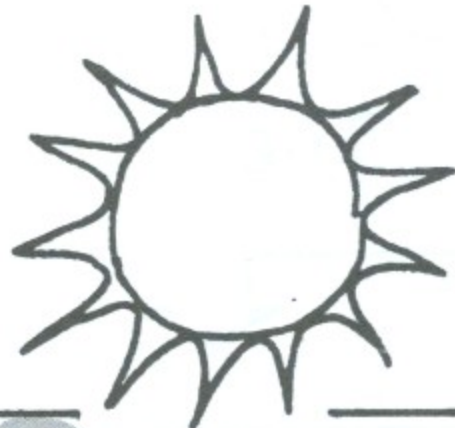

It is isn't sunny.



It is isn't windy.

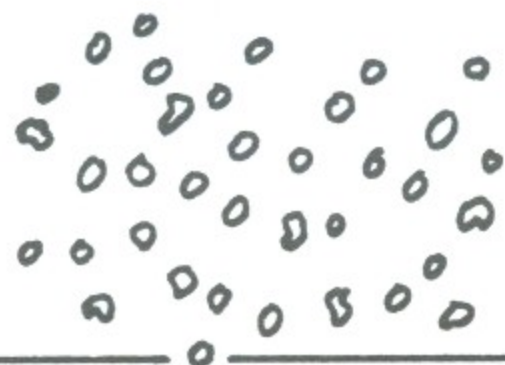

It is isn't cloudy.



It is isn't cloudy.



It is isn't windy.



It is isn't raining.



It is isn't sunny.

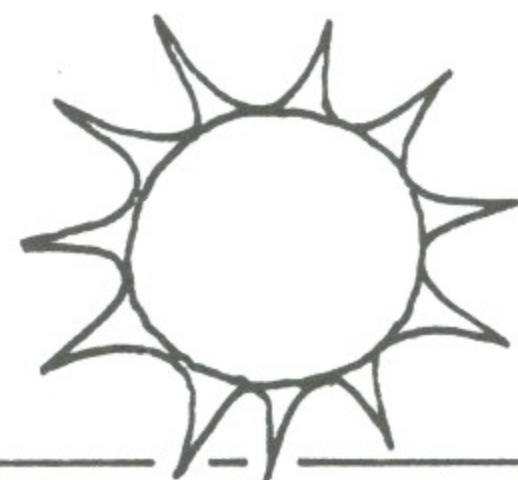

It is isn't snowing.

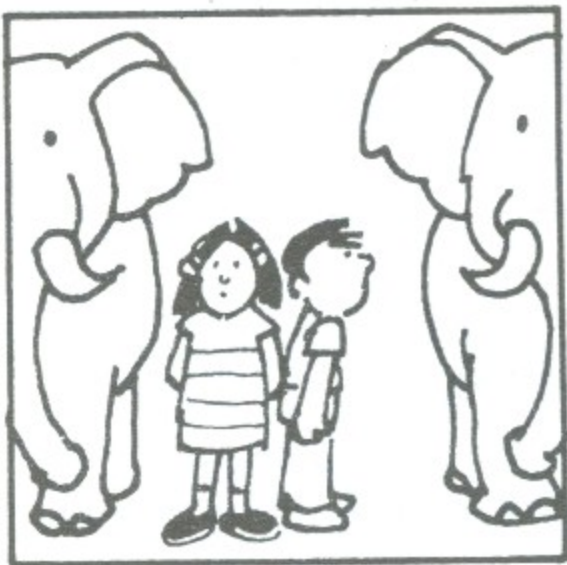
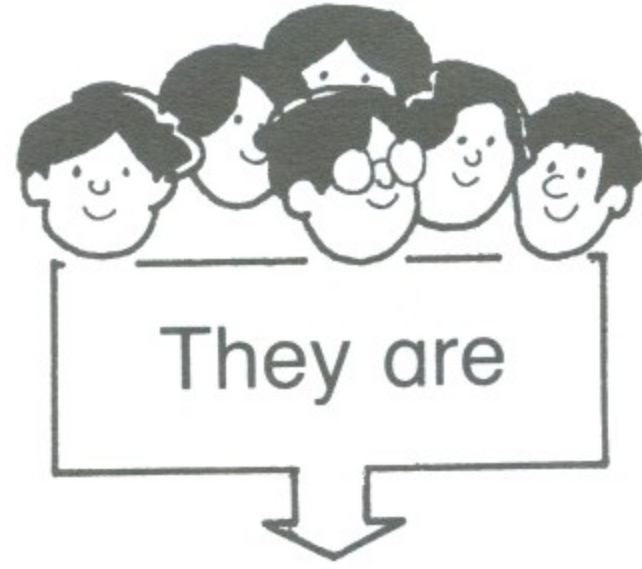
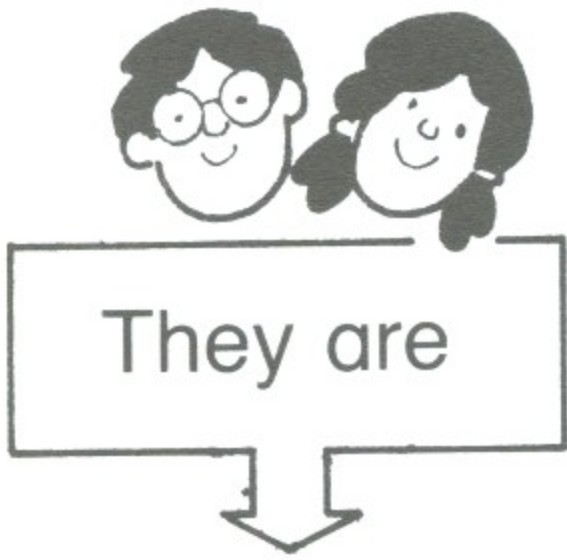
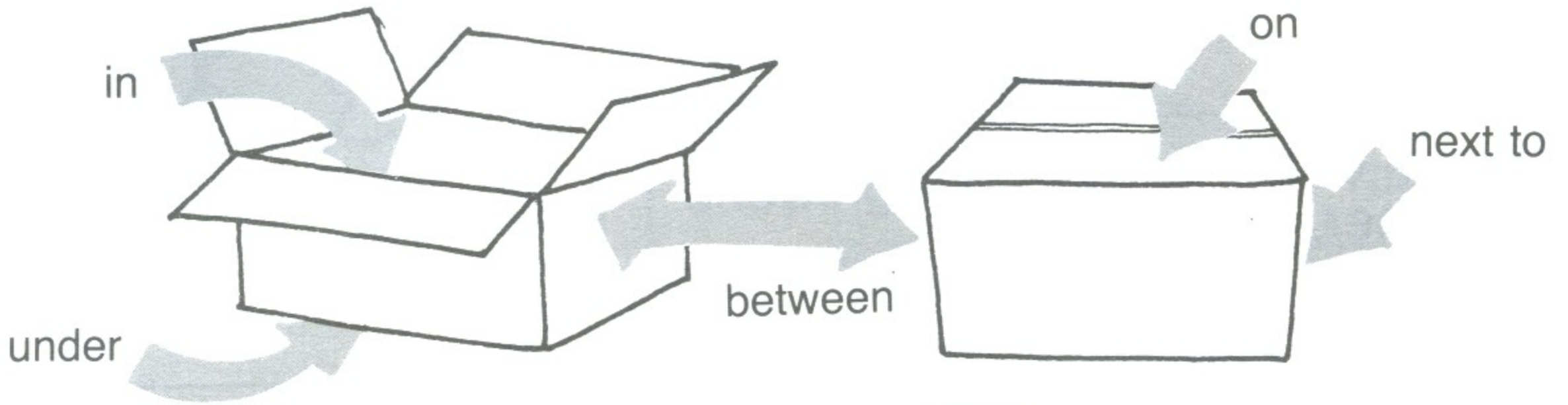

between the elephants.

under the elephants.



next to the jeep.

in the jeep.

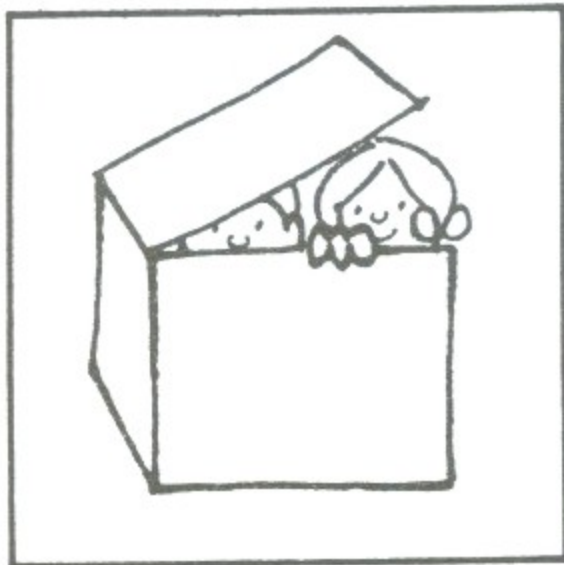

next to the box.

in the box.



on the vans.

between the vans.



on the fish.

in the fish.



next to the zebra.

under the zebra.



on the table.

under the table.



under the umbrella.

on the umbrella.

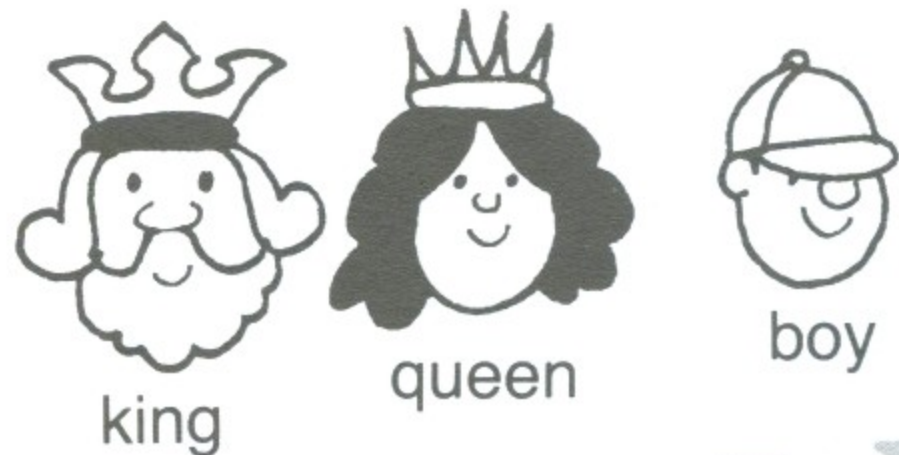

Today's weather →

sunny	windy
cloudy	
raining	snowing

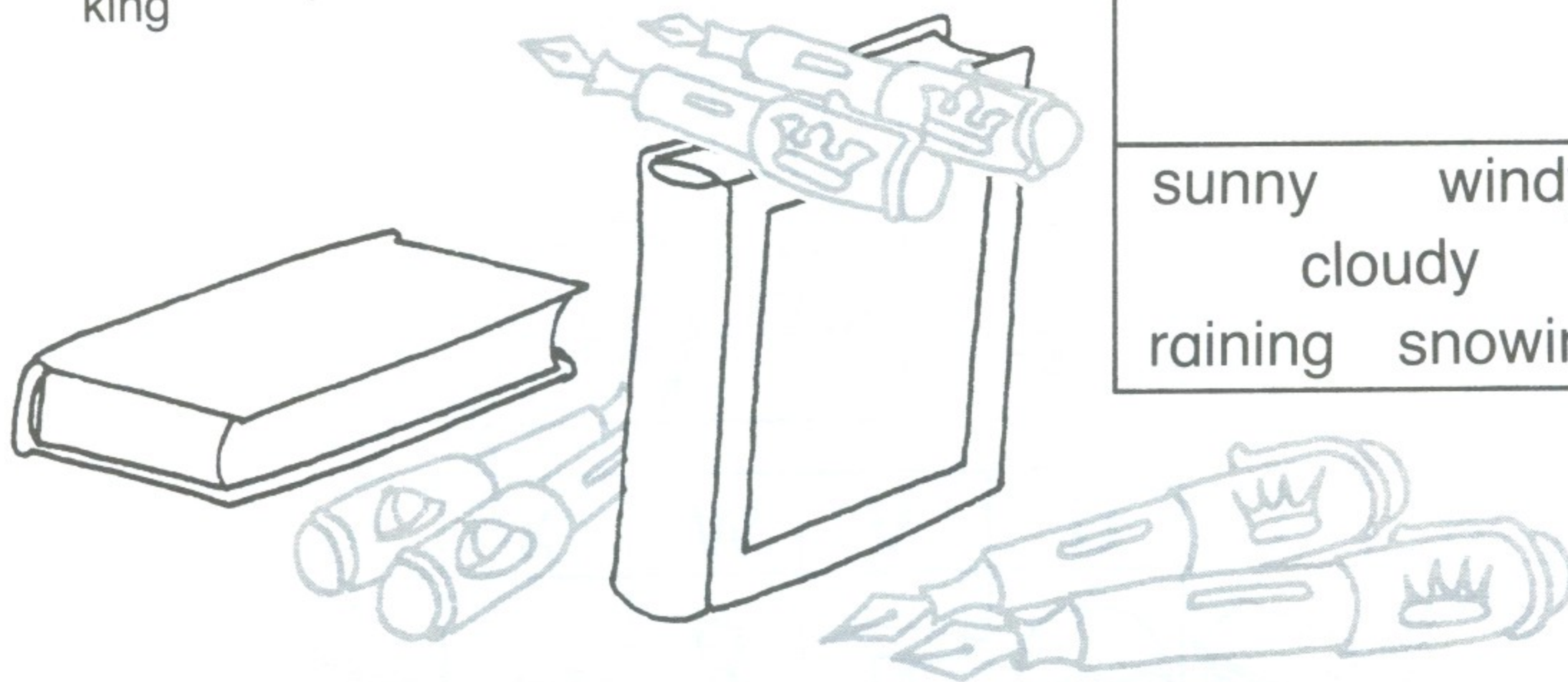

Are the queen's pens on the book?

Yes, they are. No, they aren't.

Are the boy's pens under the book?

Yes, they are. No, they aren't.

Are the queen's pens next to the book?

Yes, they are. No, they aren't.

Are the king's pens between the books?

Yes, they are. No, they aren't.

Are the boy's pens on the book?

Yes, they are. No, they aren't.

Are the king's pens on the book?

Yes, they are. No, they aren't.

Are the boy's pens between the books?

Yes, they are. No, they aren't.



b bb



p pp

bp bp



p

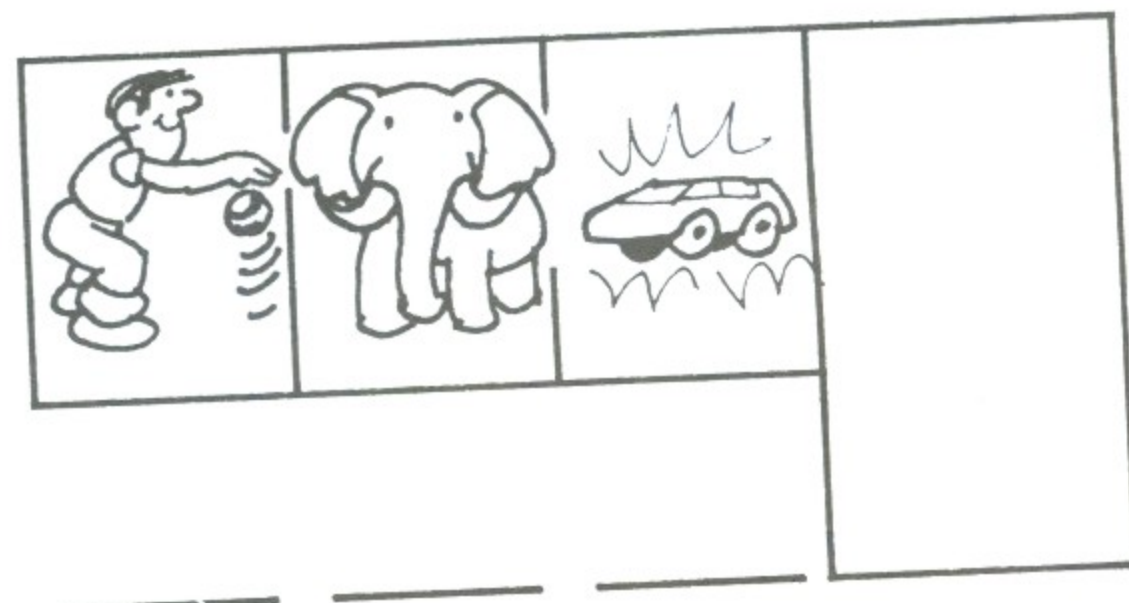
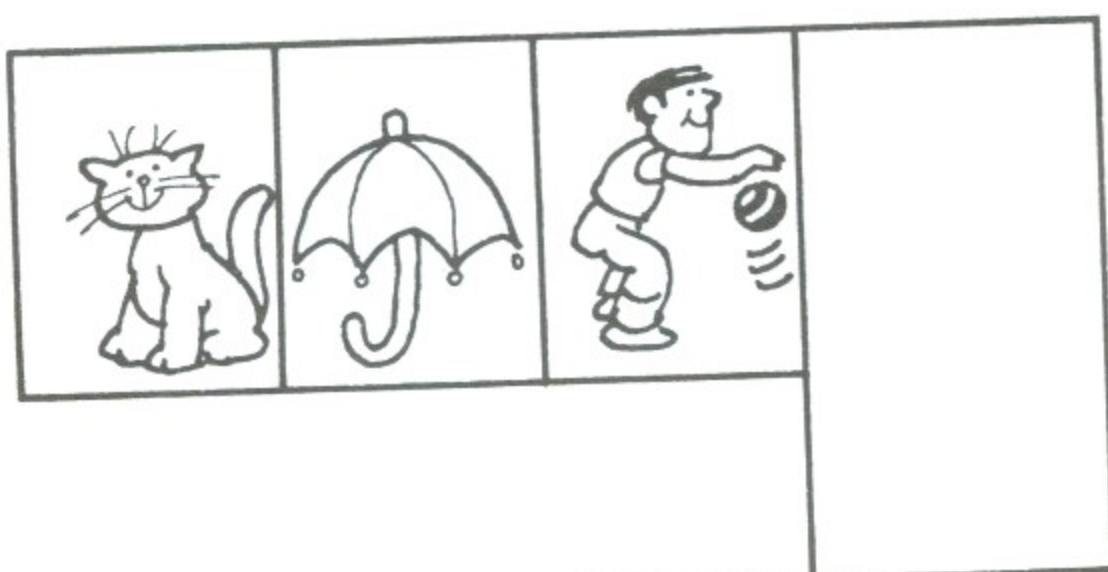
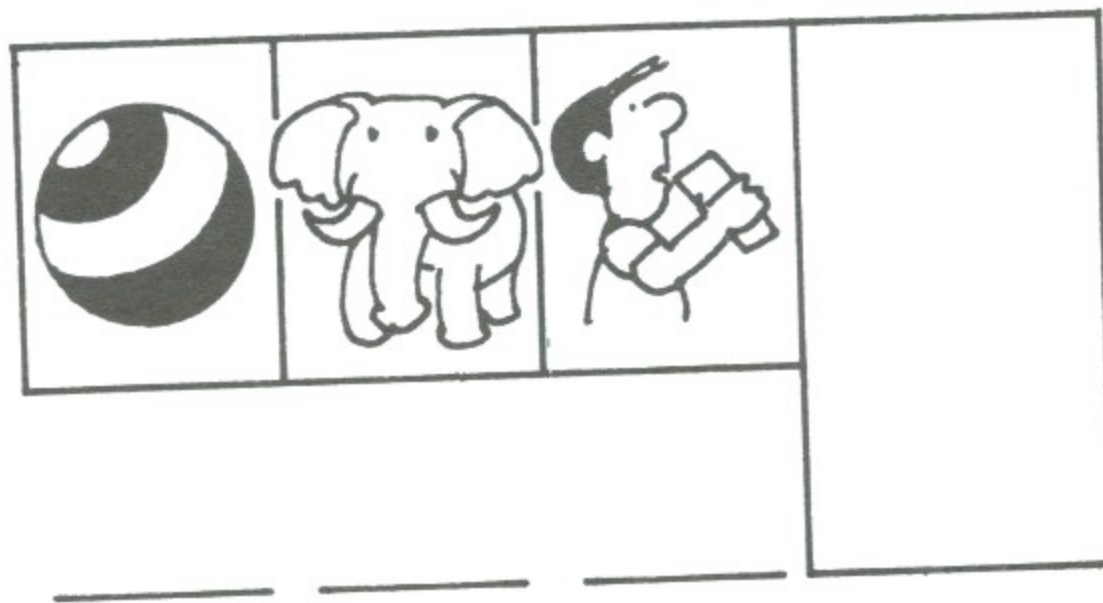
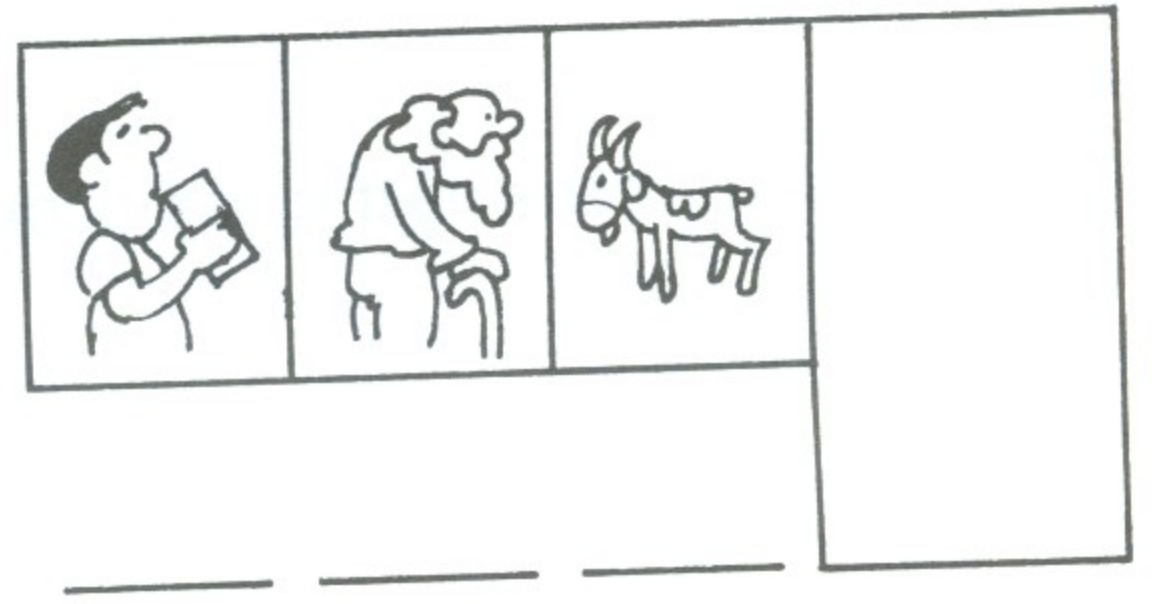
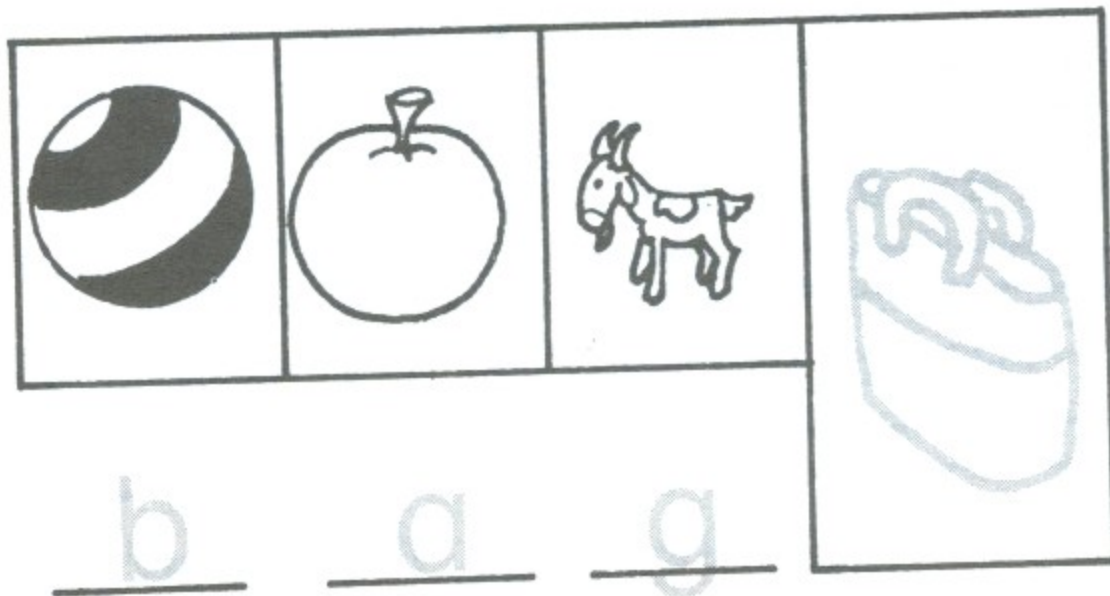
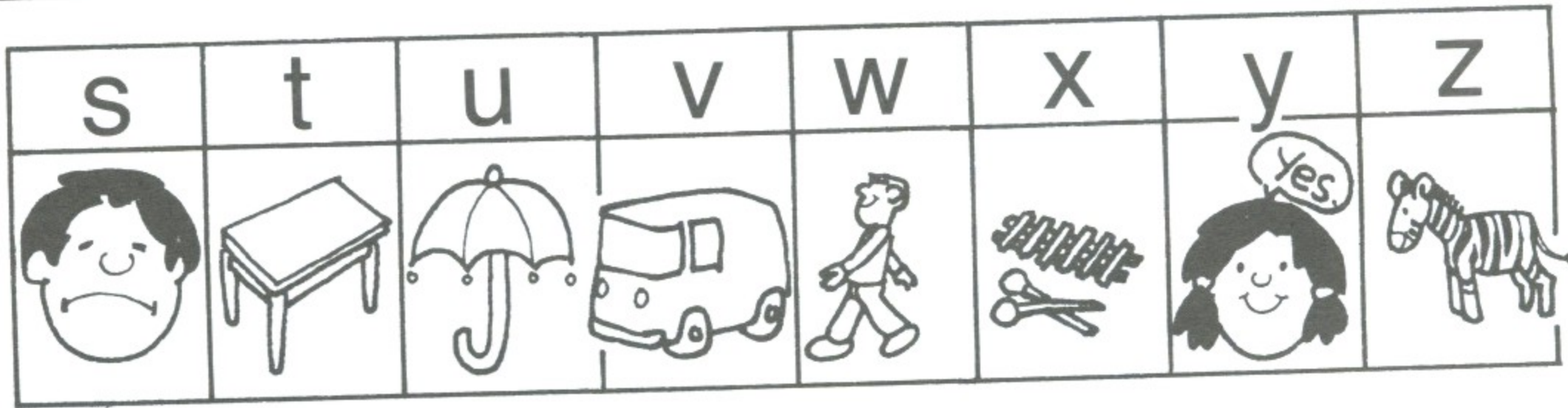
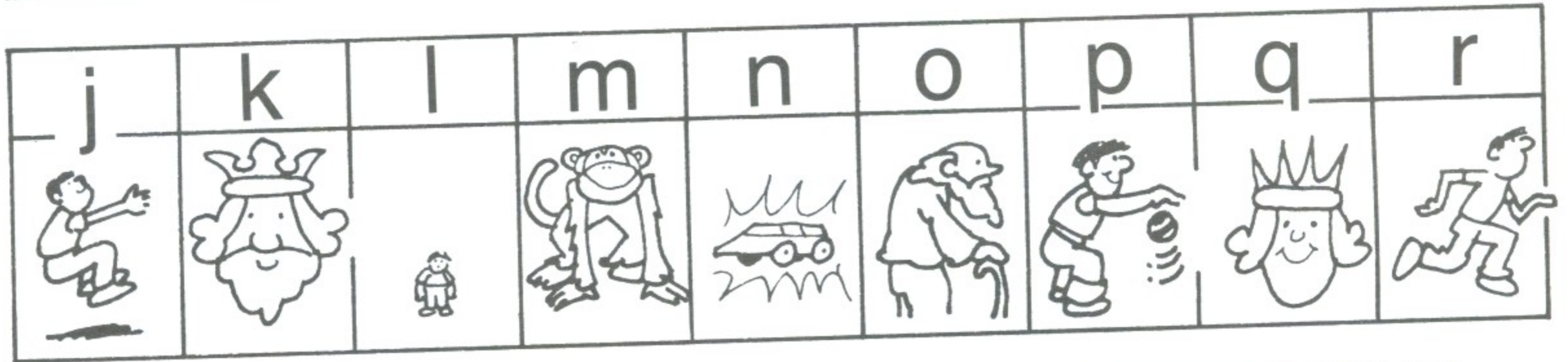
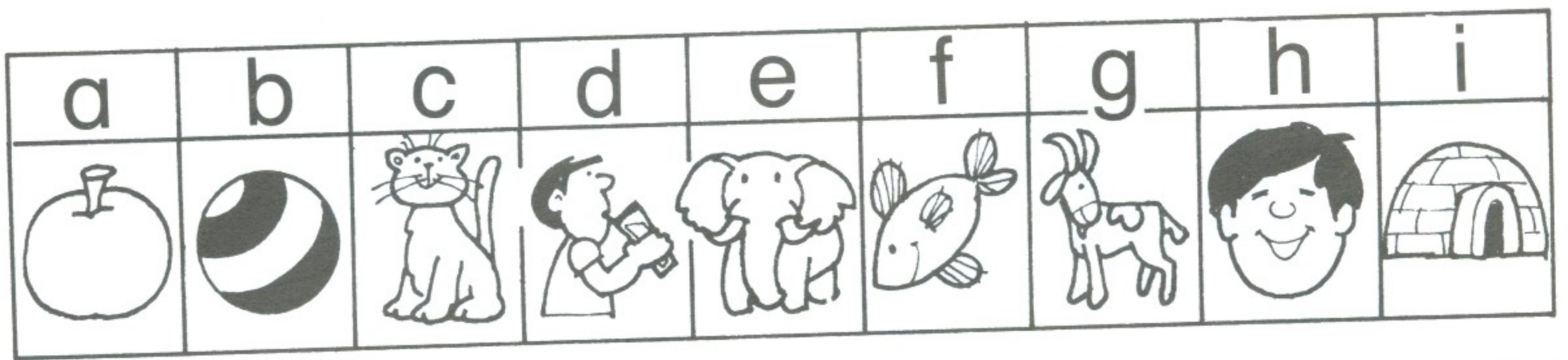

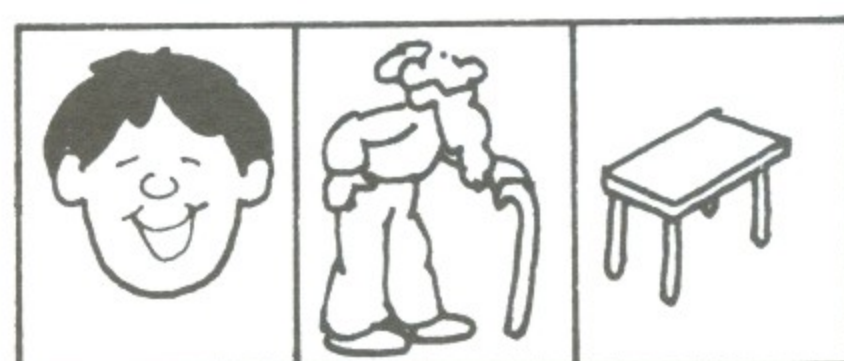
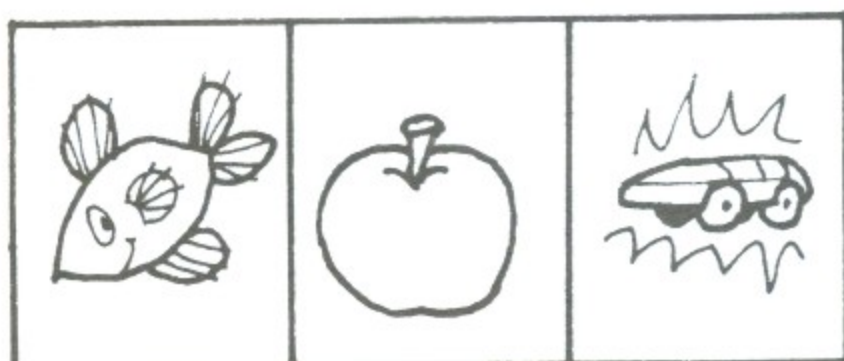
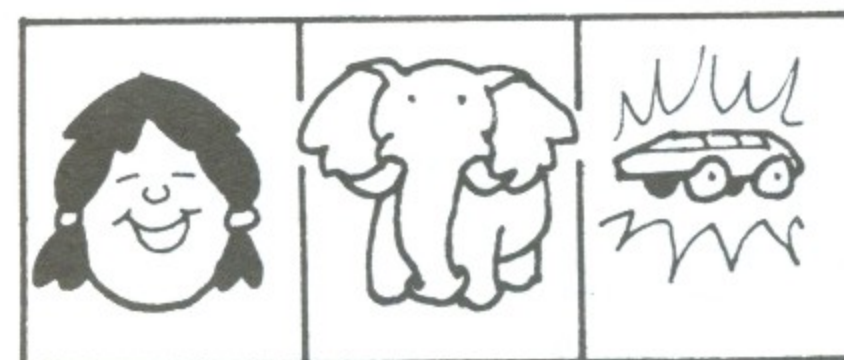
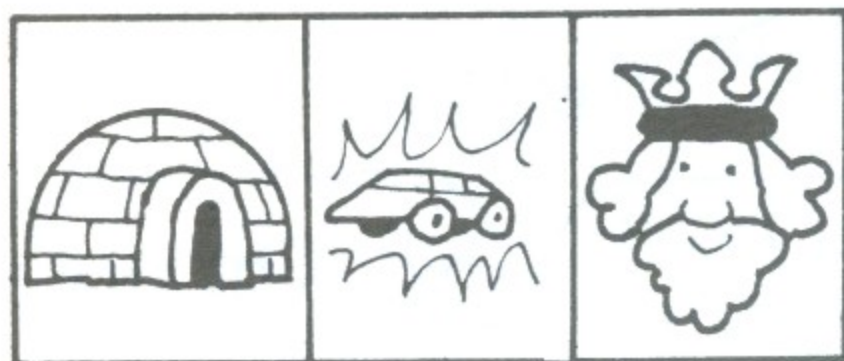
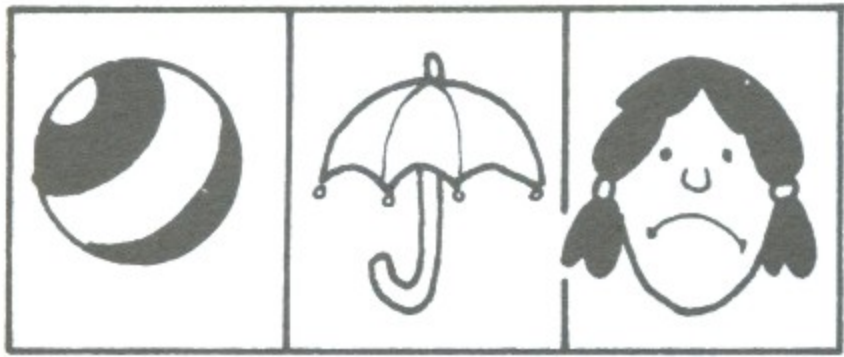
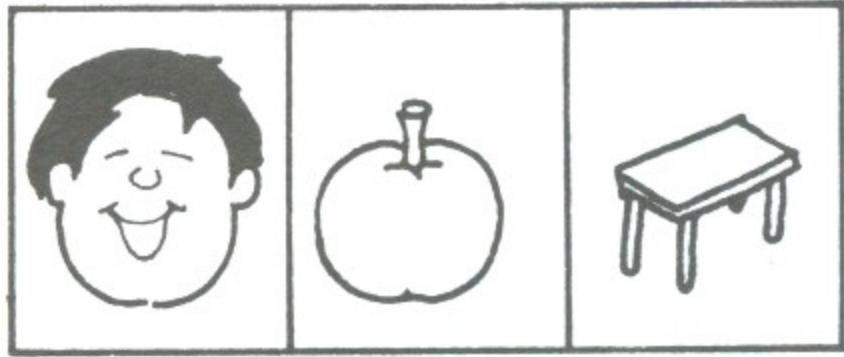
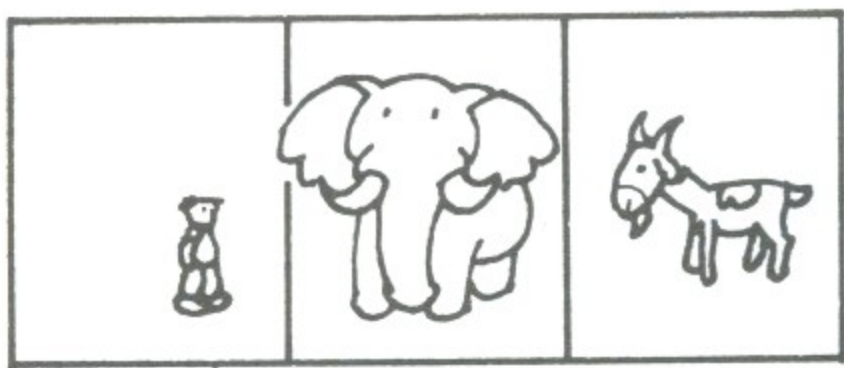

leg

boy

hen

hat

bus

fan

hot

ink

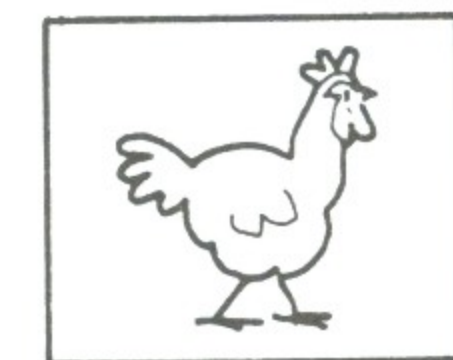
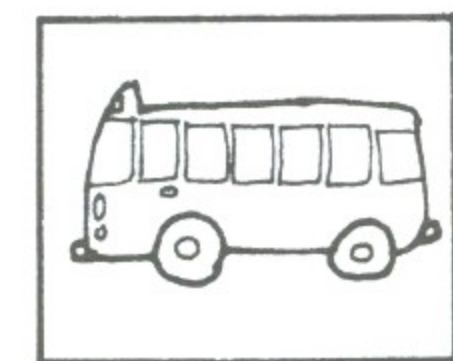
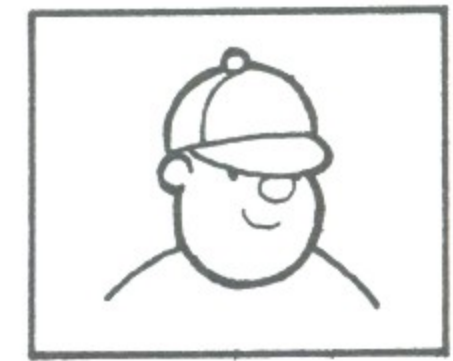
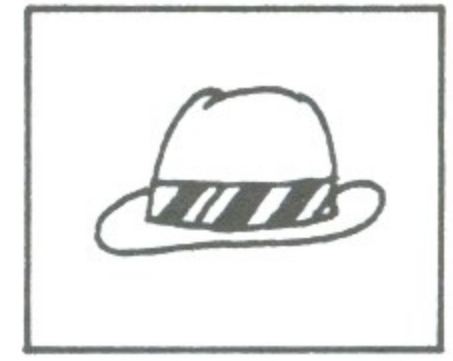
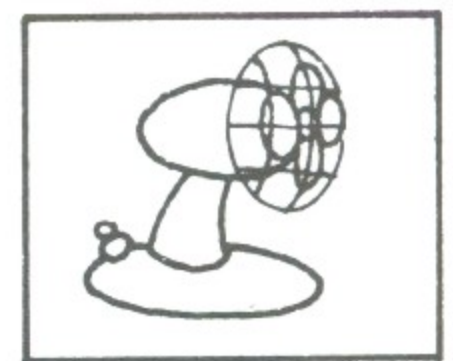

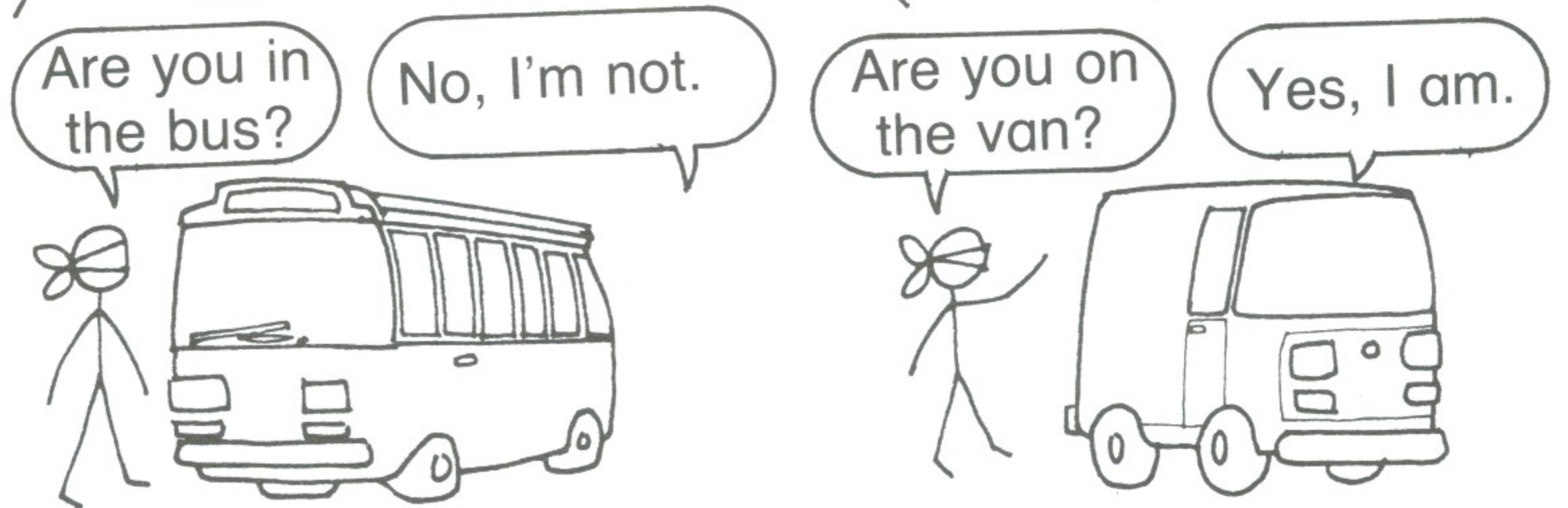

I am the oldest.



I am the biggest.



I am the youngest.



I am the happiest.



I am the noisiest.



Your family



Are you the oldest?

Yes, I am. No, I'm not.

Are you the youngest?

Yes, I am. No, I'm not.

Are you the biggest?

Yes, I am. No, I'm not.

Are you the happiest?

Yes, I am. No, I'm not.

Are you the noisiest?

Yes, I am. No, I'm not.

leg

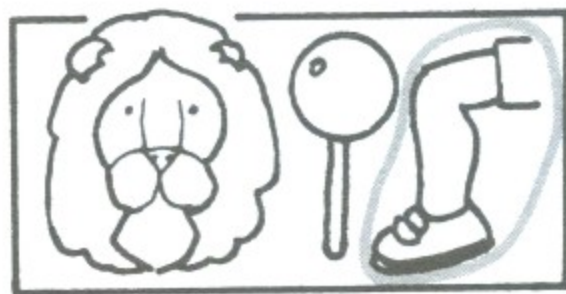

wet



jet

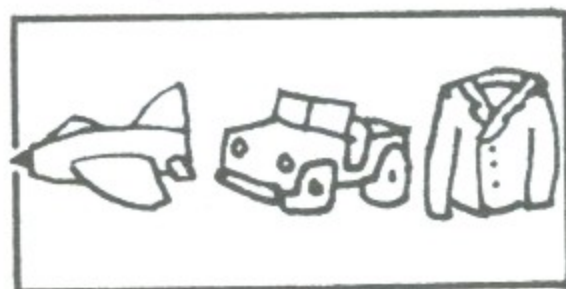

bed



1

one

2

two

3

three

4

four

5

five

6

six

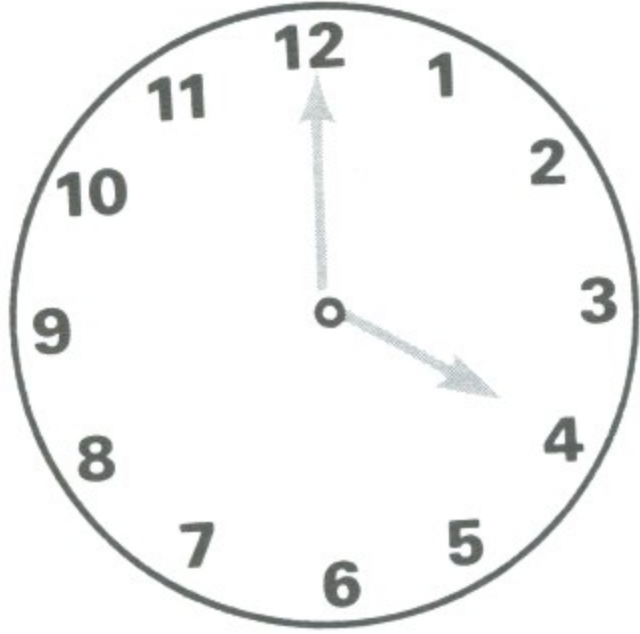

It is four o'clock.

It is

o'clock.

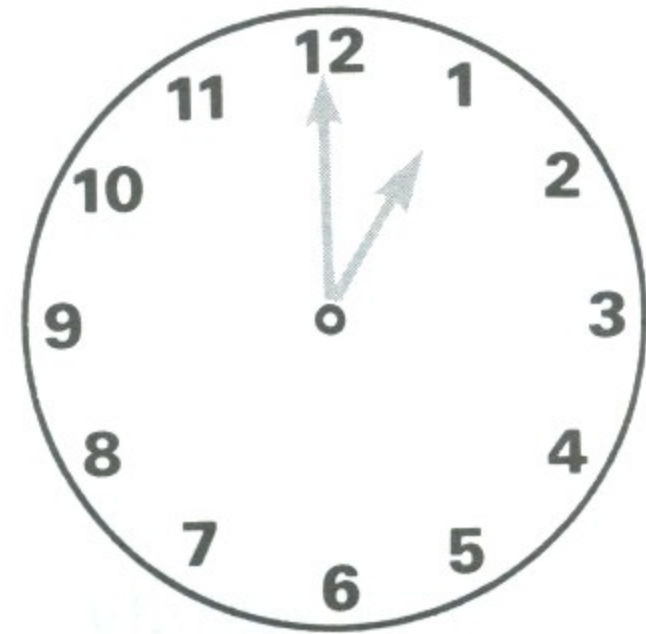

It is

o'clock.

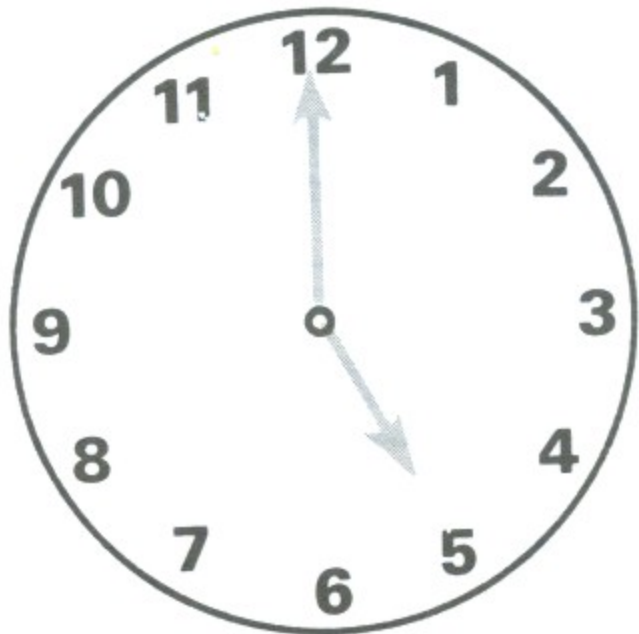

It is

o'clock.

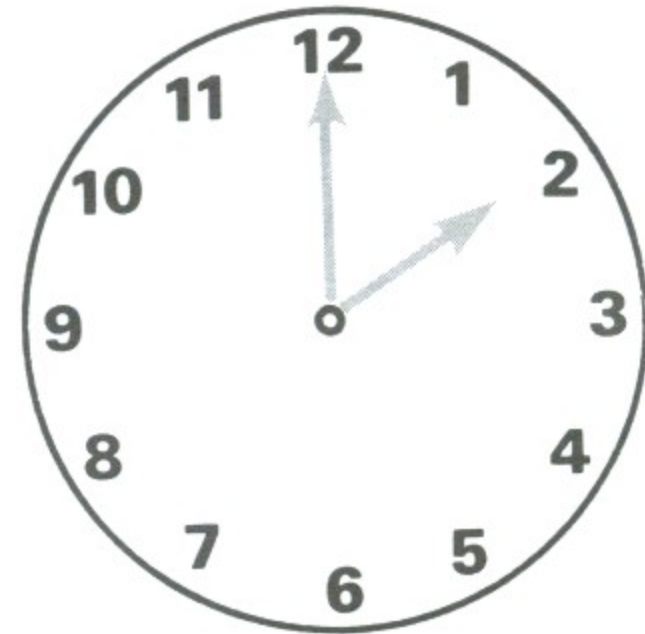

It is

o'clock.

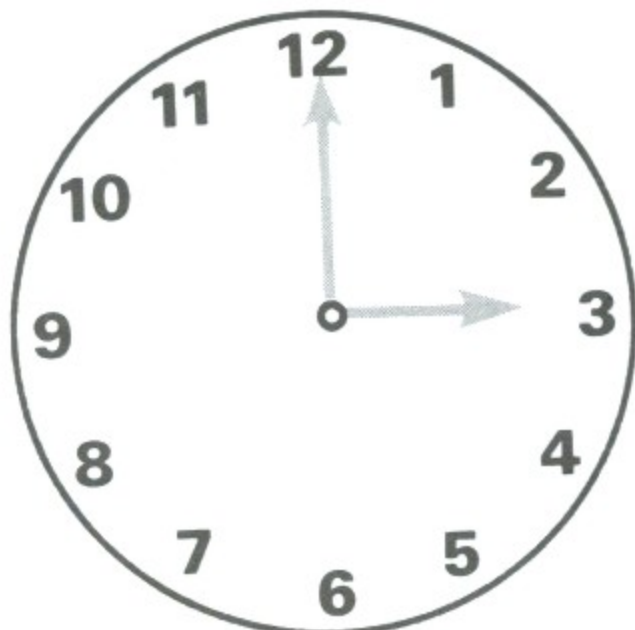

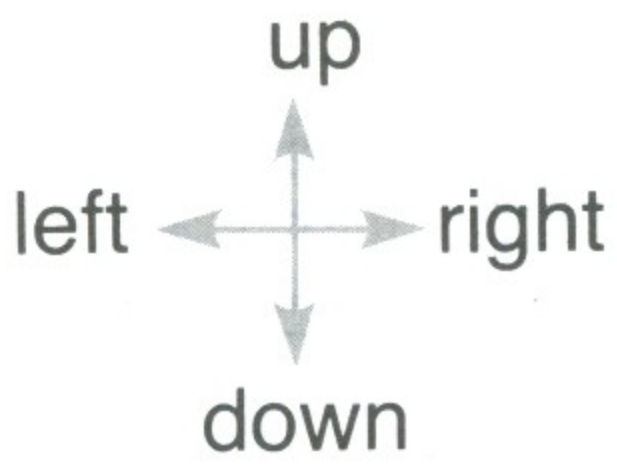

car bus

van jet

Go down four squares.
Then go right three squares.

Go down three squares.
Then go left five squares.
Then go up one square.

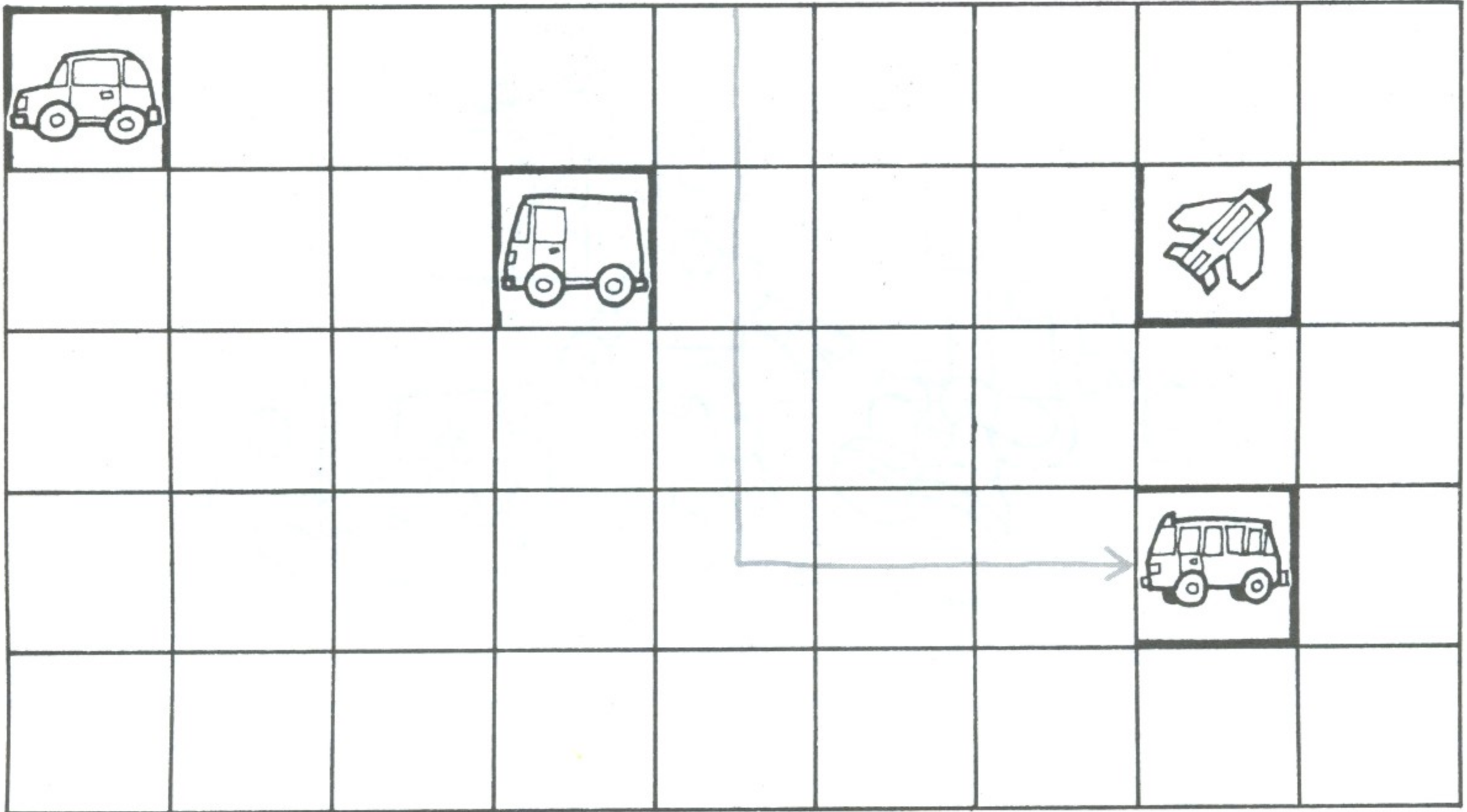

Go up five squares.
Then go right six squares.
Then go down one square.

jet bus

Go up three squares.
Then go left six squares.
Then go up two squares.

van car

box

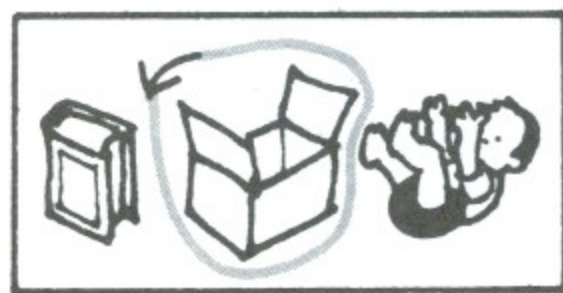

dog

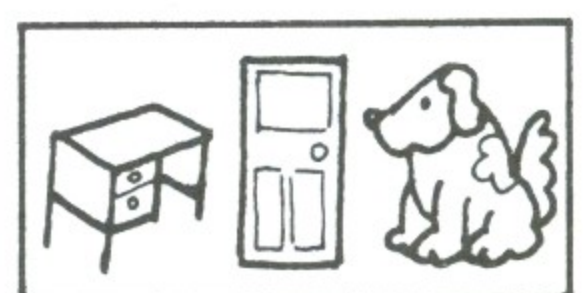

hot



rod

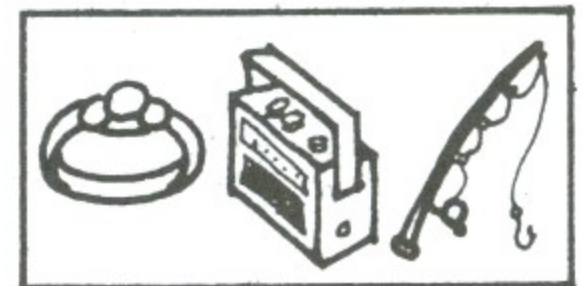

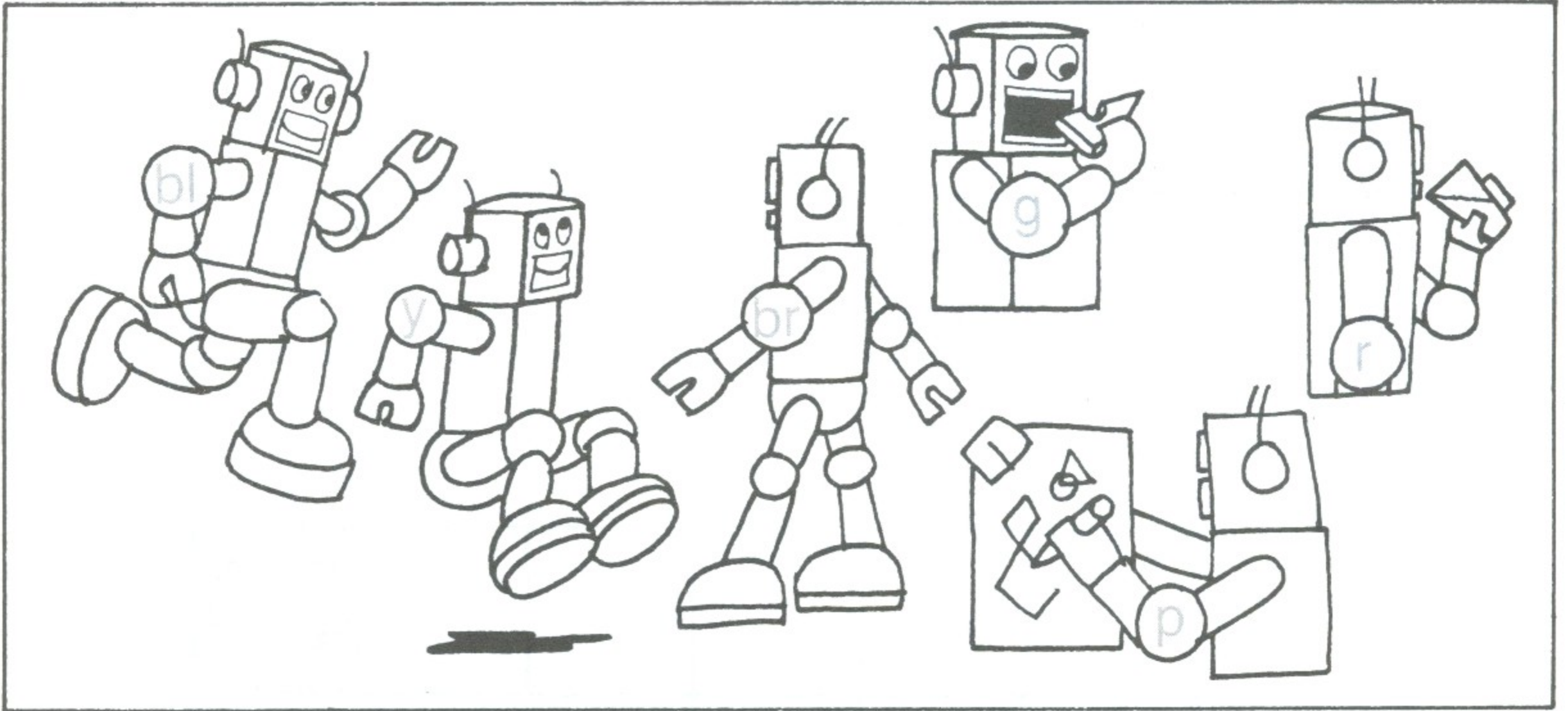
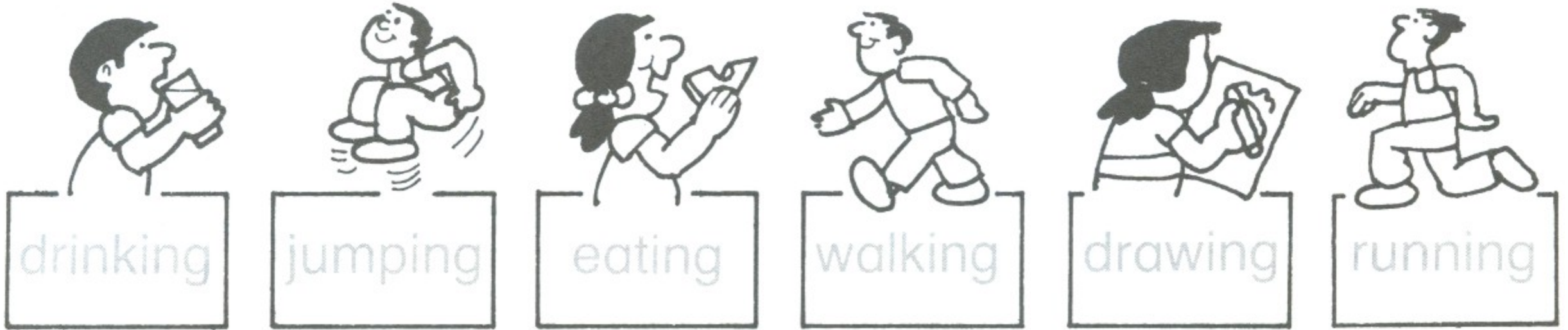

- Which one is jumping? The yellow purple one is jumping.
- Which one is walking? The brown green one is walking.
- Which one is drawing? The black purple one is drawing.
- Which one is eating? The green yellow one is eating.
- Which one is running? The red black one is running.
- Which one is drinking? The brown red one is drinking.

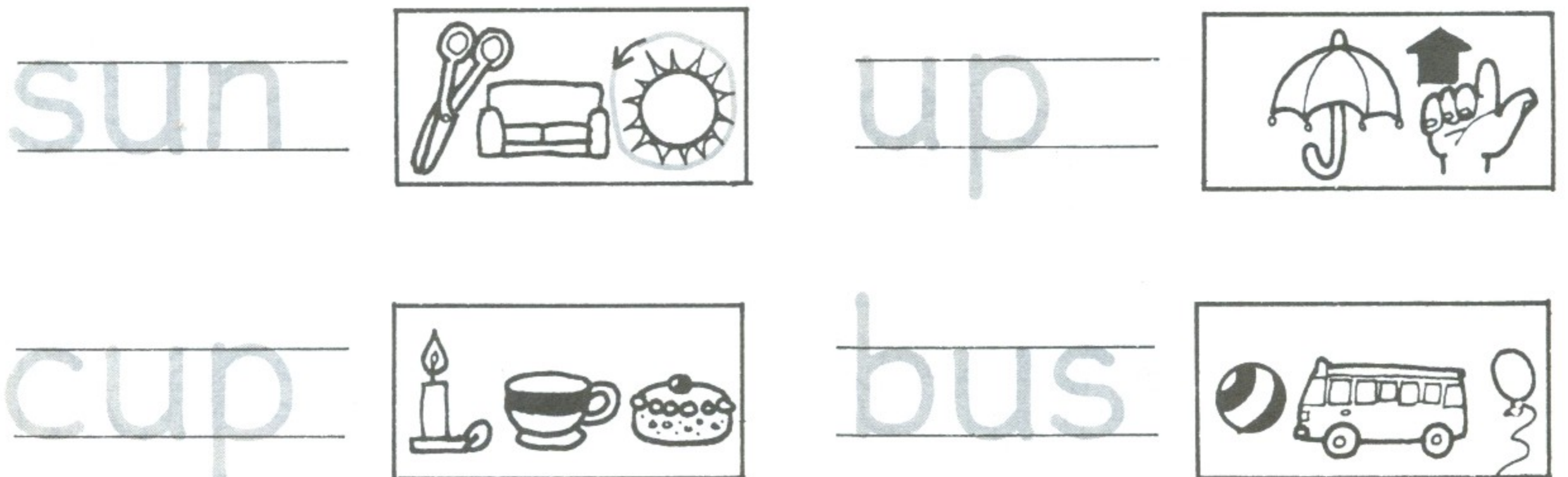

It is long.

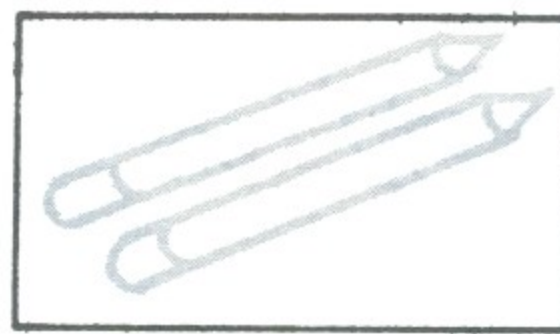
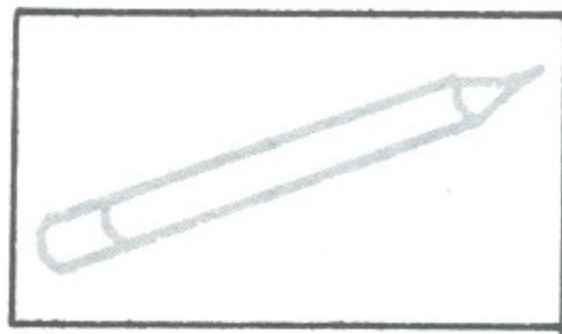

They are long.

It isn't long.

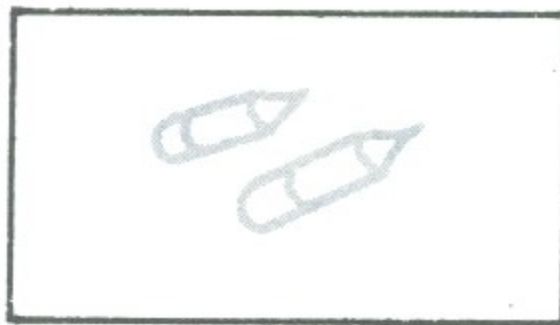

They aren't long.



She is jumping.



running.



drawing.



running.



drinking.



jumping.



eating.



walking.

He is	He isn't	She is	She isn't
It is	It isn't	They are	They aren't



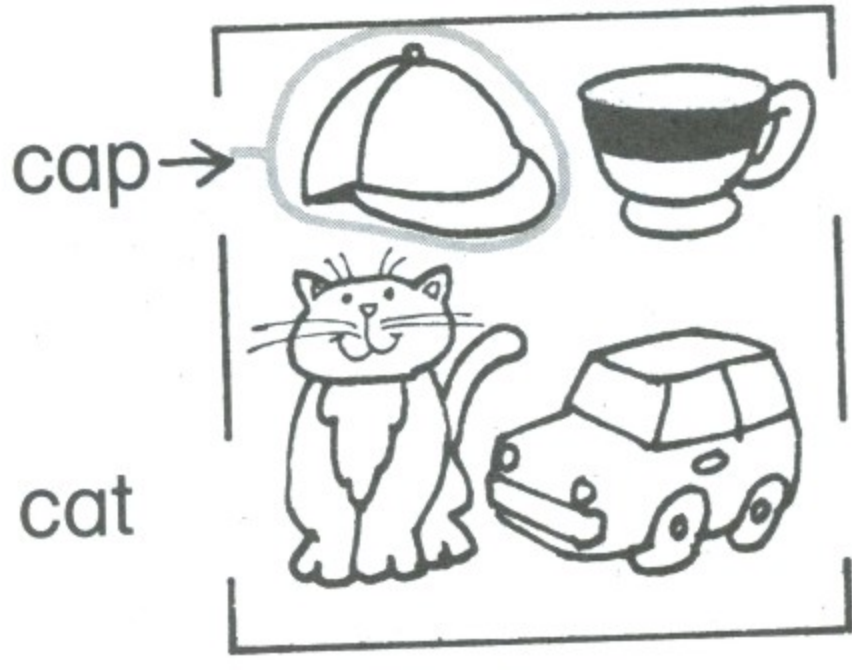

cap →

car

cat

cup

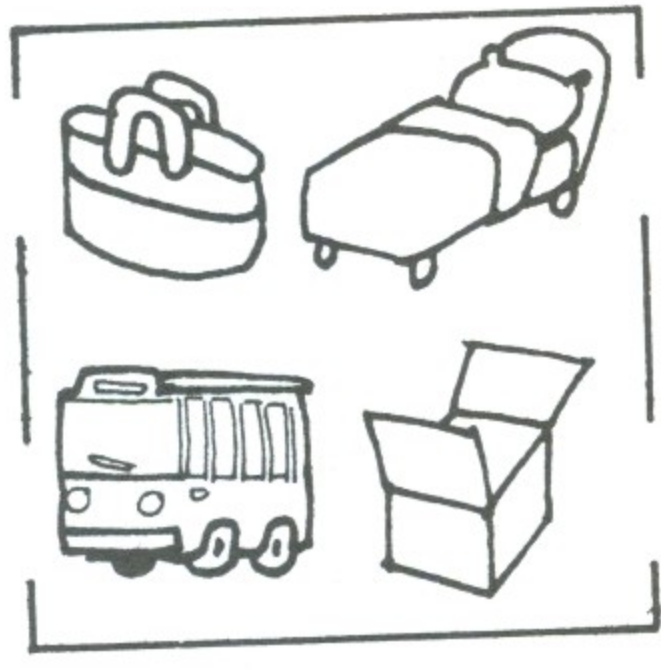

bag

bus

bed

box



a little bag



an old _____



a wet _____



an old _____



a long _____



a big _____



a new _____



a little _____

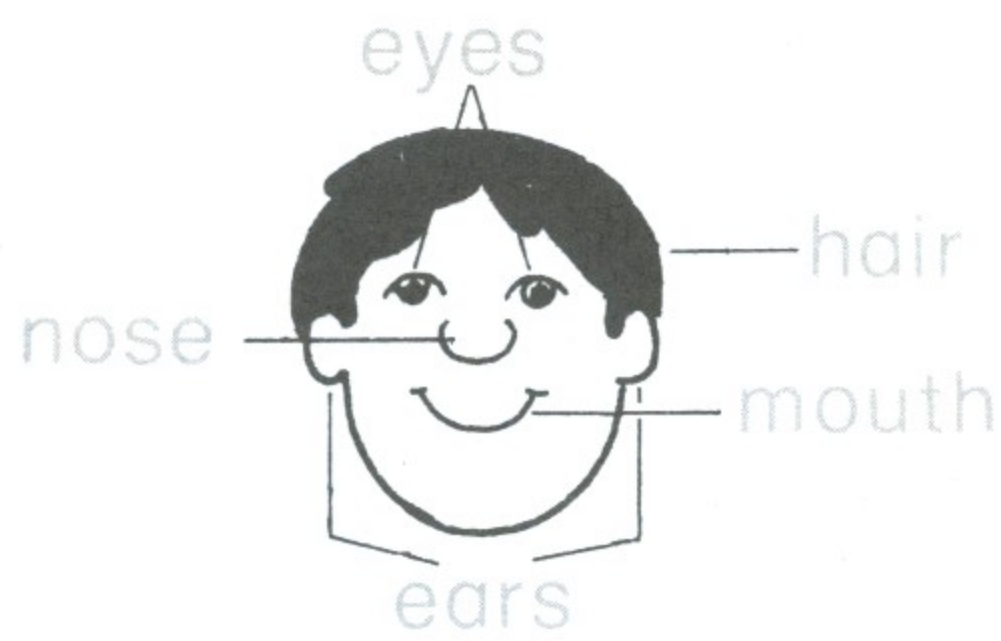

Pam

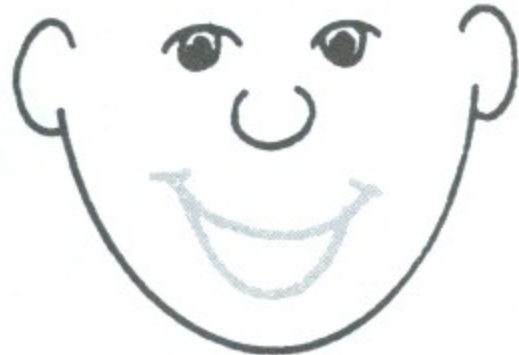

Sid



Tom



Jan

Sid's mouth is the biggest.

Pam's nose is the longest.

Tom's ears are the biggest.

Jan's hair is the longest.

Tom's eyes are the biggest.

Jan's nose is the shortest.

Pam's mouth is the thinnest.

Sid's hair is the shortest.

cap



van

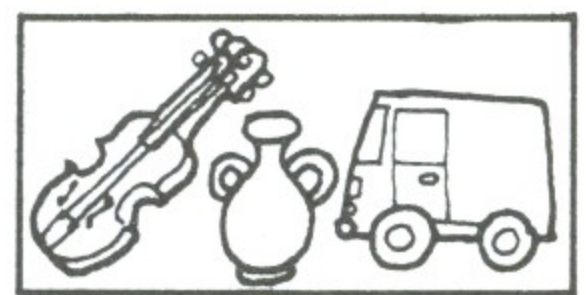

fat

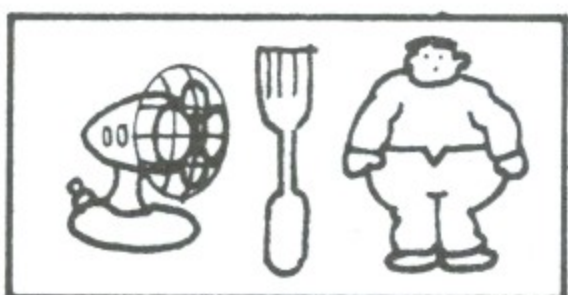

hat

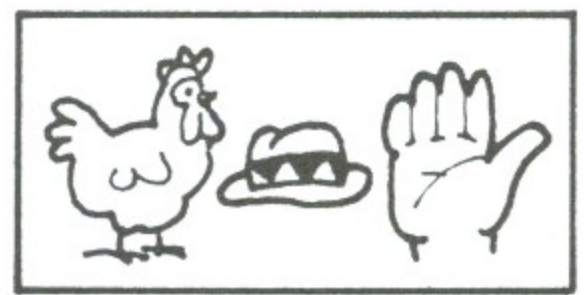



She ~~is~~ isn't young.



He ~~is~~ isn't old.

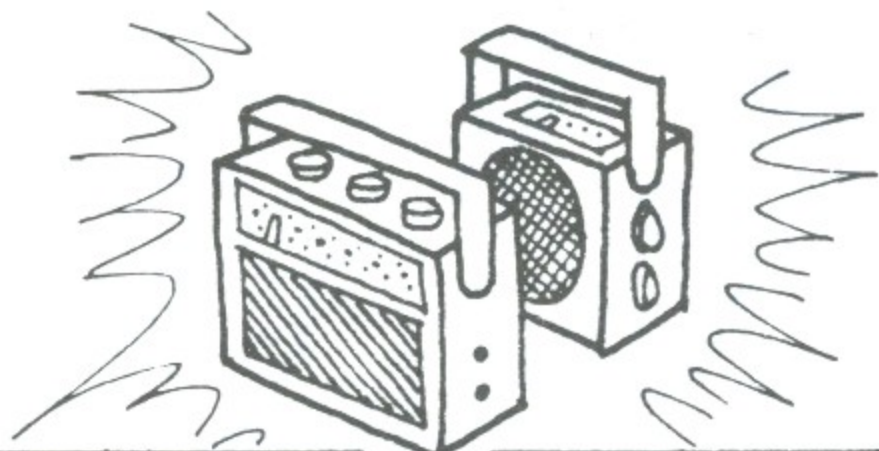

They ~~are~~ aren't new.

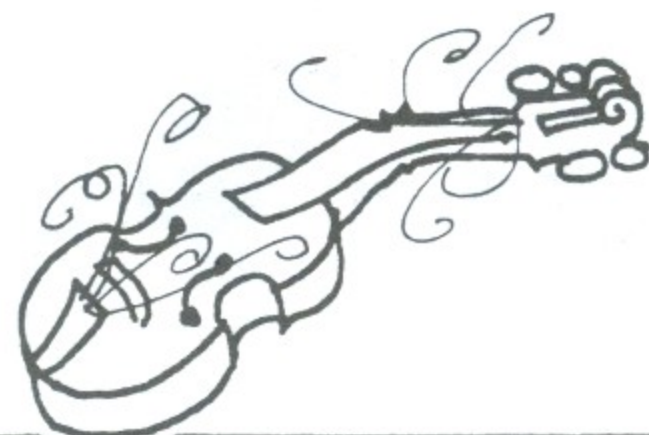

It ~~is~~ isn't old.



They ~~are~~ aren't jumping.



She ~~is~~ isn't drinking.

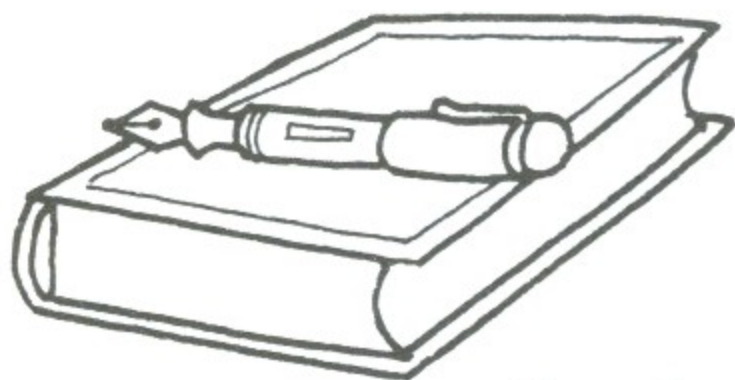

Is the pen under the book?

Yes, it is. No, it isn't.

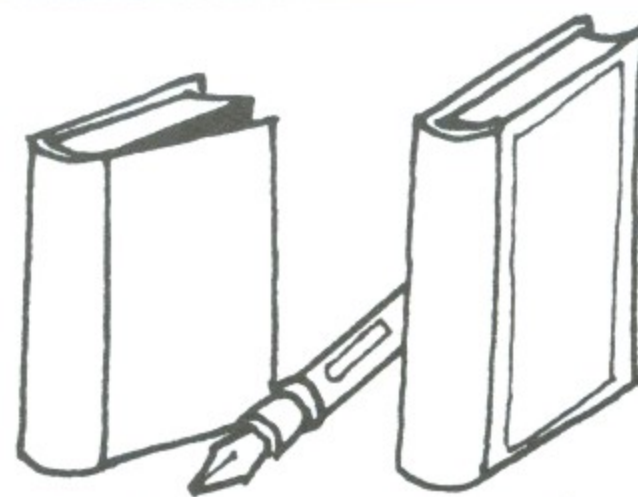

Is the pen between the books?

Yes, it is. No, it isn't.



Are the pens in the bag?

Yes, they are. No, they aren't.



Are the pens next to the bag?

Yes, they are. No, they aren't.

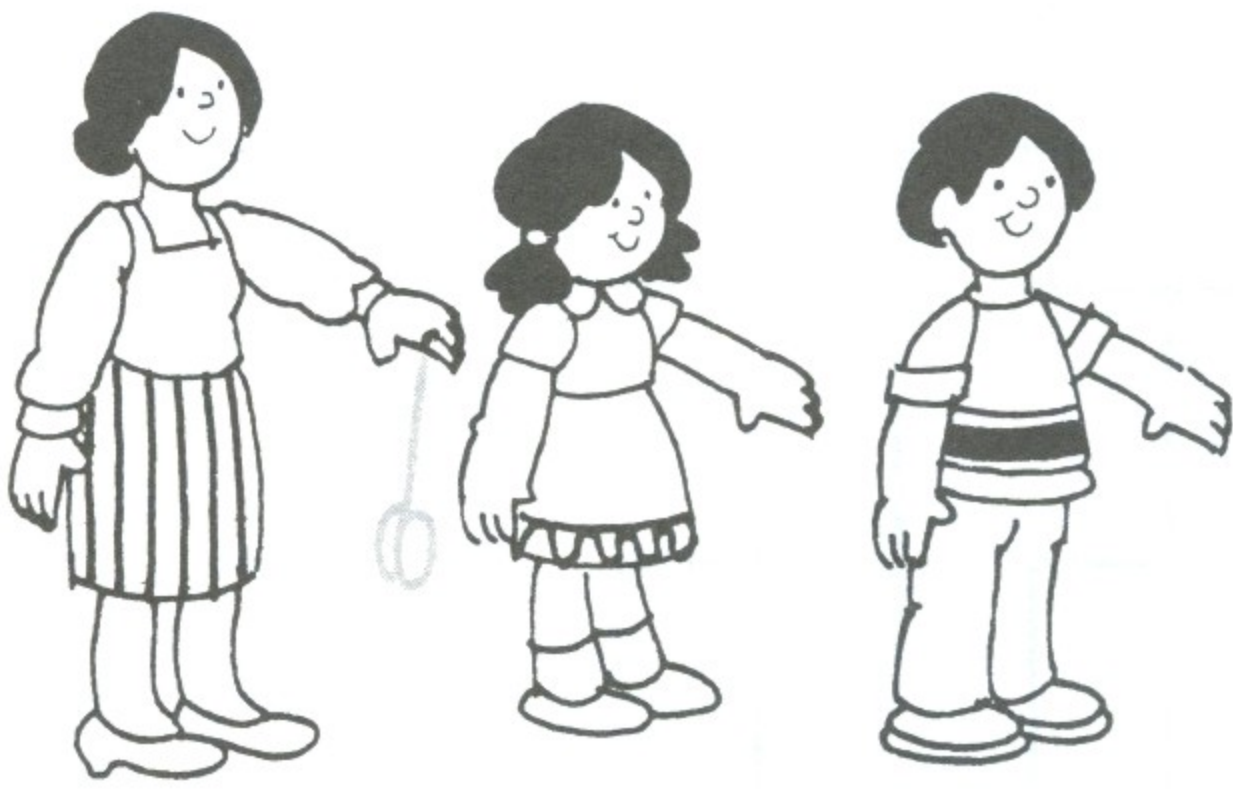

The girl's yoyo is the longest.
The boy's yoyo is the shortest.

Today's weather



sunny	windy
cloudy	
raining	snowing

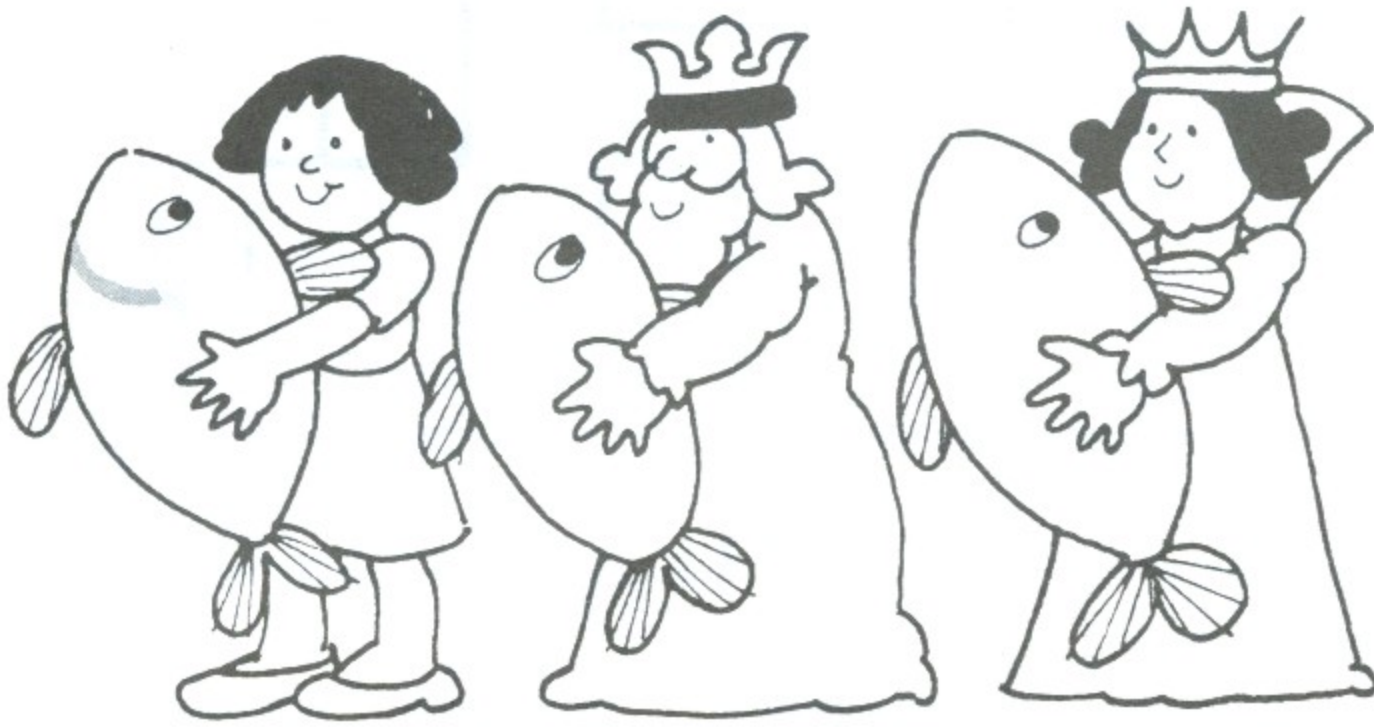

The queen's fish is the happiest.
The king's fish is the saddest.

van

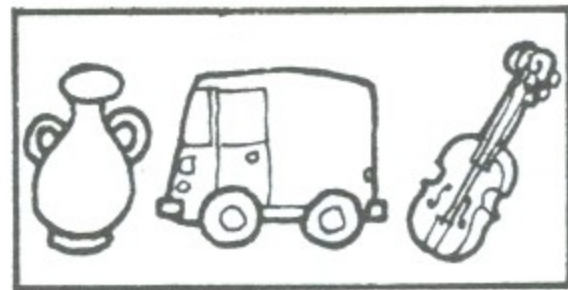

cat

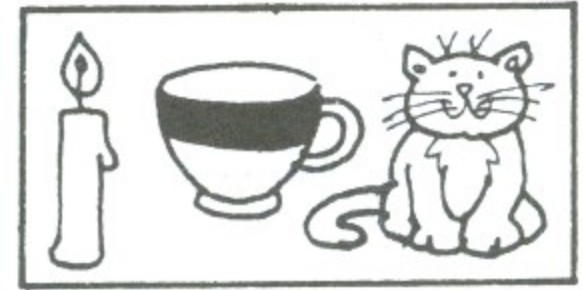

fat



man



sad



bag

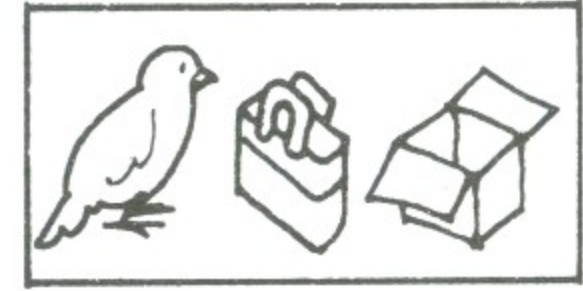

cap

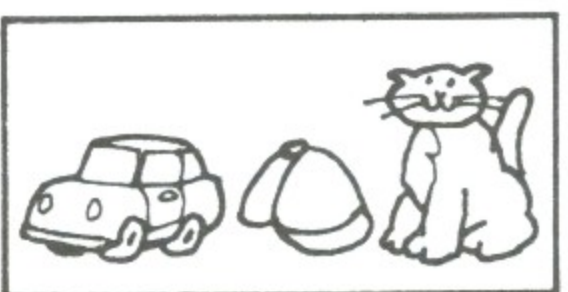

fan

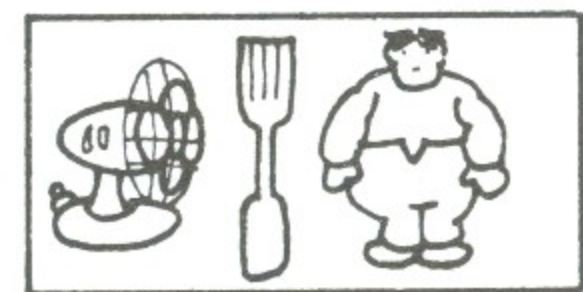

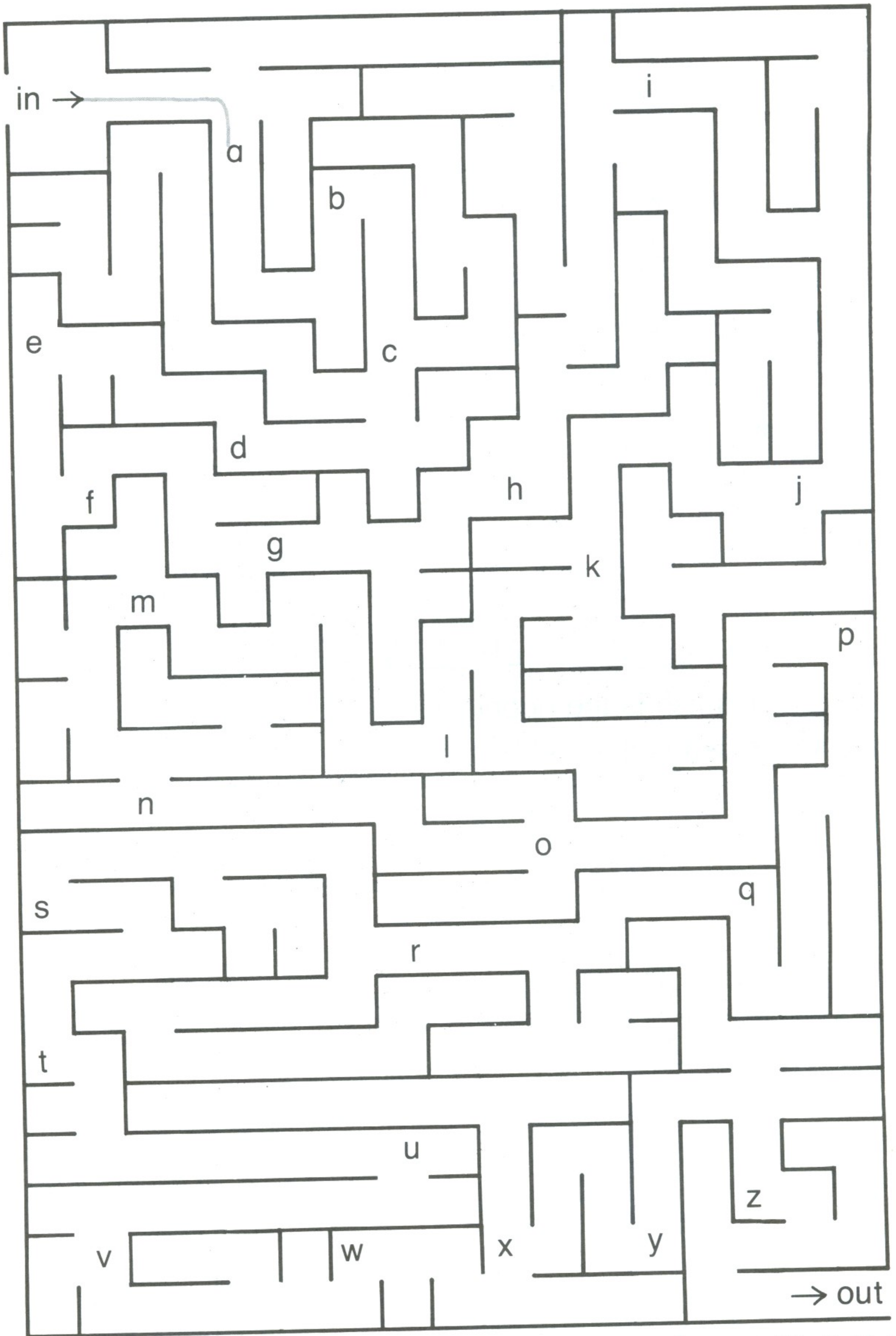

a b c d e f g h i j k l m n o p q r s t u v w x y z

a

n

b

o

c

p

d

q

e

r

f

s

g

t

h

u

i

v

j

w

k

x

l

y

m

z



Activity Books for Children are packed with engaging and creative tasks to help your pupils learn English. All the activities are attractively illustrated and have been carefully designed to practise English grammar and vocabulary, and to develop important reading and writing skills.

Also available

- Activity Book for Children 1
- Activity Book for Children 2
- Activity Book for Children 4
- Activity Book for Children 5
- Activity Book for Children 6
- Language Learning Cards A
(for *Activity Books 1-3*)
- Language Learning Cards B
(for *Activity Books 4-6*)

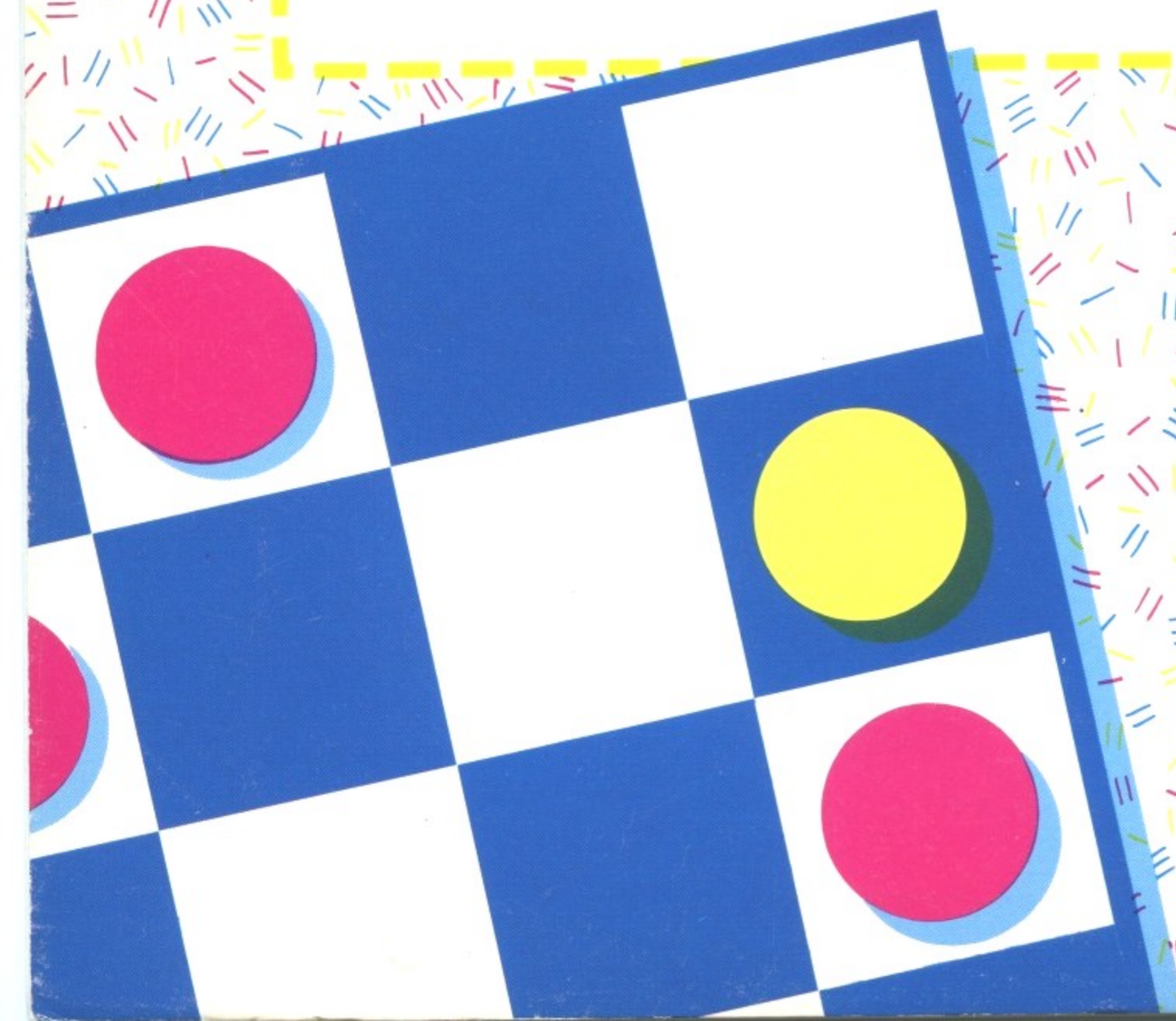

Oxford University Press

ISBN 0-19-421832-5



9 780194 218320